



General Catalogue
2017 | 2018

elegance, performance,
reliability, respect for the environment.
this is the mission of Foster
for you to Live the Quality.

Sinks



06

Undermount sinks



61

Complements



86

Mixer taps



92

Dishwashers



107

Gas cooker hobs



111

Induction
& electric hobs



142

Ovens - Microwave
Blast Chiller
Coffee Machine



161

Hoods



181

Refrigerators



210

News - Foster Milano Collection

Art, ingenuity, harmony. These are the elements that have inspired a collection of appliances unique in its genre, with stylistic and technical content at the highest levels of the Italian production.

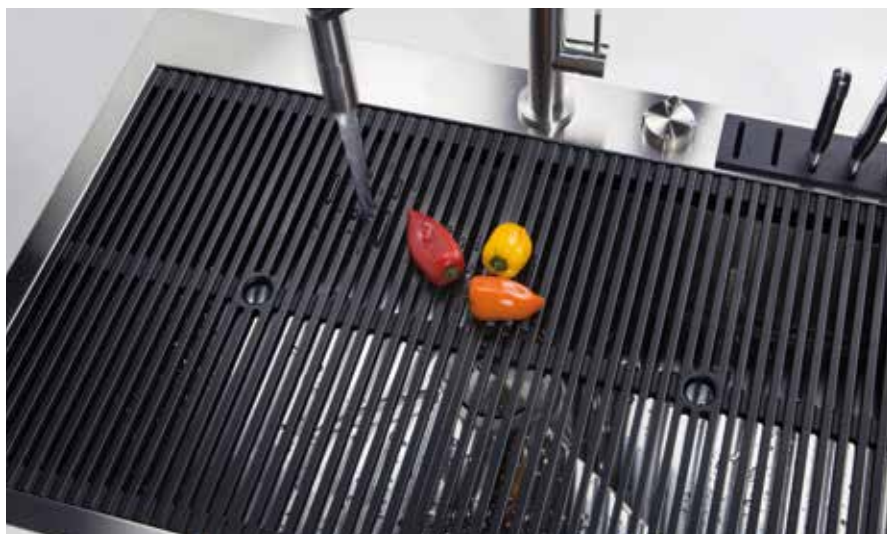

Foster Milano sinks

A collection of sinks unique in its genre. XXL bowls, precious materials and finishes with a unique and practical set of accessories.

Sinks, page 11

Undermount sinks, page 63



Foster Milano cooker hobs

Extra-large grids and professional performances are the main features of the new collection of cooker hobs which, along with the flush-mount and Q4 solution, now offers also the precious range top units.

Cooker hobs, page 115

Rangetop, page 118



Foster Milano ovens

In perfect consistency with the rest of the collection, the Milano oven features an above-average size. A harmony highlighted also by the details, like the precious metal knob which is the hallmark of the entire collection.

Ovens, page 175

News

Next to the Milano Collection, many other innovations span the whole range: innovative products, new finishes and configurations make for a more complete range.



Sinks

CQ. The circle and the Quadra concept unite in an innovative round sink, complimented by an original set of accessories (p. 27).

Other news: New Wave, p. 14, Quadra, p. 24, KE Gold, p. 78, KE Copper, p. 79, S1000 Single bowl pag. 60.



Dishwashers

There are many innovations, with two new three baskets' models, the A+++ energy class, and an increased capacity up to 16 place-setting. The restyling of the classic KS model is also available. Pp. 108, 109 and 110.



Cooker hobs

The new induction with suction system completes the Foster Milano collection. The range of induction hobs also features new models and solutions, such as the 90 cm, 5-plates S4000 hob, or the 77 cm, 4-plates S1000 hob, pp. 146, 148 and 152.



Multifunction Blast Chiller

The series of FL Black Mirror compact ovens is enriched with a professional, high-performance appliance, offering a surprising array of features and great versatility.



Ovens

A new oven and hood are the forefront of the new Stripe collection, offering a new and... stripy look.

Stripe oven, pag. 179; Stripe hood, pag. 198



Hoods

New ceiling suction systems, new designs and new built-in models complete the already rich range of Foster hoods, pp. 188, 189, 192, 197, 198, 200, 201, 202, 203, 204 and 205.

the Collections



Foster Milano

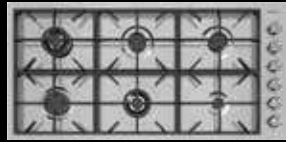

GK



S4000 / S4001



Domino



FL



KE



KS



Marine



Elettra



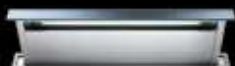



The Sinks

Foster takes great care to use materials able to provide the best performance. Our entire range is made with **AISI 304 - 18/10** and **AISI 316** austenitic steels. Thanks to the high percentages of chrome and nickel they contain, they give a particularly bright finish, and make the products extremely sturdy and absolutely resistant to rust and corrosion. An incredible range at your disposal, counting as many as 26 sinks' families.

Foster Milano p. 11



New Wave p. 14



GK p. 16



S4001 p. 18



S4000 p. 21



Quadra p. 23



CQ p. 27



Master p. 28



FL p. 29



KE p. 30



Triplo invaso p. 33



S3000 p. 34



Marine p. 37



KS p. 39



F300 p. 41



Elettra p. 43



FM p. 45



Big Bowl p. 47



Big Bowl Soft p. 49



Moon p. 50



Uragano p. 52



Tornado p. 53



Angolare p. 55



Diamant p. 56



Circolari p. 57



S1000 p. 58



Undermount sinks p. 61



Designer finishes

The exclusive finishes on Foster steels are the result of painstaking research, the aim being to achieve the perfect combination between good looks and functionality.

A distinctive feature, a true trademark that makes our products stand out for the ease with which they can be cleaned.



 Foster finish

Foster brushed finish

The steel is treated with special vegetable fibres that give it the characteristic extrafine satin finish that is highly elegant and functional. **This makes the surfaces very smooth and easy to clean.**

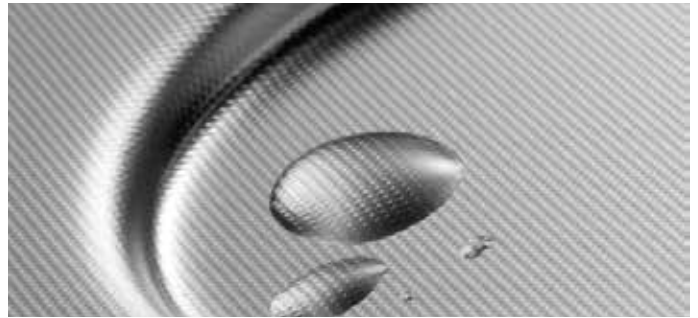

 Microfoster finish

Microfoster® finish

A scratchproof finish with an exclusive, extrafine and almost imperceptible textured appearance that gives the steel a special shine and sets off the style to its best effect.

PVD finish

NEW

A new look for the classic, exclusive AISI 304 steel, thanks to the innovative PVD physical treatment (Physical Vapor Deposition). This allows the deposition of precious metals on steel surfaces, giving a unique look and greater resistance to scratches and wear.

Available in Gun Metal, Gold and Copper finish.

KE Gun Metal undermount bowls pages 76-77

KE Gold undermount bowls page 78

KE Copper undermount bowls page 79



Vintage finish

NEW

An artificially worn look, along with the convenience of a steel surface that is not afraid of scratches and nicks.

The asymmetric brushing obtained with traditional methods simulates the signs of aging and gives the steel a new and original appeal.

GK Vintage Sinks and cooker hobs pages 16, 65, 120.

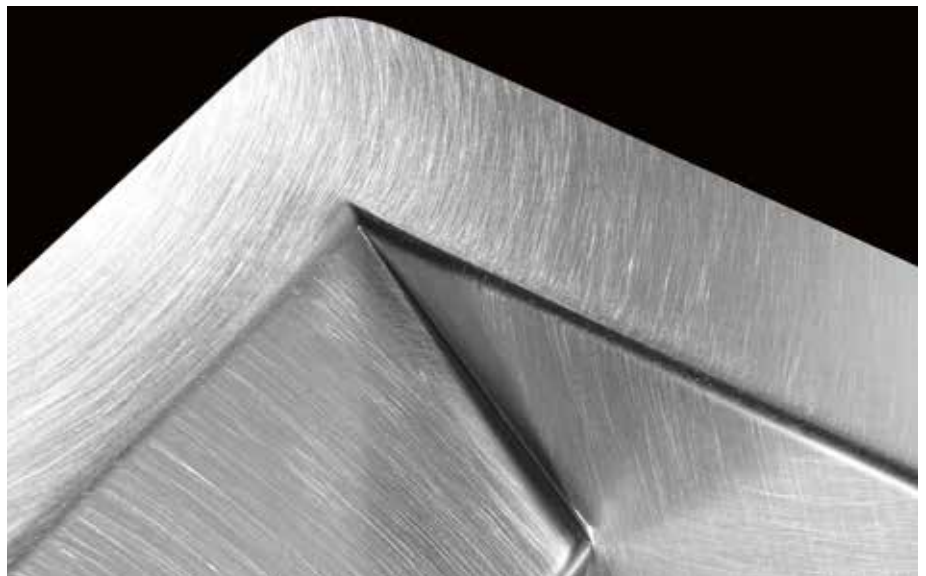

Built-in and beyond

The methods with which worktops can be built-in have become increasingly more varied and customized. Foster was the first sink manufacturer to have researched and used the new recessing methods and has thus acquired a great deal of experience. It now offers the most comprehensive range available on the market, with flush-mount, flat-edge and undermount installation.



Standard

Traditional built-in with the vertical, 8-mm edge.



Q4

The casing has a square edge that stands on the work surface by just 4 mm. Great solution to match the sink with the ceramic glass hobs (Induction).



Flat-edge

An original edge, with an inclined, 3 mm high profile, matching an extreme elegance with the easiness of installation.



Flush-mount

The product is sunk in 1,5 mm deep recess thus being perfectly flush with the worktop. As alternative, it can be installed on the worktop as well.



Undermount

A classy and contemporary idea, to be installed under the worktop; available in various types of sinks, with soft or square design.



Built-in

Almost the whole range of Foster sinks can be integrated into stainless steel worktops; it is the most elegant and professional solution, that creates a seamless work-surface. The products that can be welded are listed hereafter.

Flush-mount & Flat-edge: a clarification to be done

Many manufacturers indicate as Flat-edge a Flush-mount edge mounted on the worktop.



For Foster Flat-edge means a real alternative built-in solution with an elegant 3 mm sloping edge.

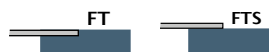

In any case, Foster's Flush-mount models can be mounted on the worktop (as in the detail in the picture), thus offering a further built-in solution.



Features

In designing a kitchen, it is essential to create a washing area tailored to one's requirements.

As a matter of fact, statistics show that most of the time spent in the kitchen involves preparing and cleaning food or washing dishes, therefore, using the sink.

Essential aspects to consider when choosing a sink include the quality of the steel, manufacturer's warranty, shape and size of the bowls and available accessories, be they standard or optional. Foster offers all of this in over 300 items, to enable everyone to choose his/her "OWN" sink.



Sturdy sinks

For every type of sink (welded or single-moulded) and price bracket, Foster works with above-average steel thickness when compared to other manufacturers. As a result, also owing to our long experience, we are able to construct "sturdy" sinks displaying a unique design.

Spacious bowls

Thanks to the pioneering manufacturing technology used, all the bowls in Foster sinks provide a generous depth (even the single-moulded versions, i.e. formed from a single sheet of steel). The bowls in many of the versions are more than 20 cm deep, thus sizeable and practical for all washing operations.

Bowls with tight radius

Bowls with squared-out shapes, a modern design and more capacity. Foster proposes a wide range of choices with different manufacturing technologies and corners with different radiuses.



Mixer tap holes

On many Foster sinks the ample tap area is already provided with two tap holes. Many sinks can be customized with on-demand additional holes, to be requested on the order. These can be used for taps requiring two holes, for automatic waste fittings or for soap dispensers. This feature is marked on the drawings by means of a dotted outline.

Diamond-shaped bottom

The water drainage on the bowl's bottom is an important feature, always well cared for on Foster sinks. In the squared-out, flat-bottomed sinks, the draining is ensured by the elegant diamond-shaped creases that make the water flow easier.

Waste fittings

Foster sinks are equipped with a generously sized 3.5" waste fitting and practical strainer plug that prevents solids from flowing away with the waste water. The 3.5" drain allows the Foster waste-disposer, which is compatible with all models, to be used. (Compatibility with the waste-disposer of other manufacturers is not guaranteed).



Waste fitting with remote control

The waste fitting with remote control is part of the standard equipment supplied with some of the models. A very convenient accessory that saves you from wetting your hands when the bowl needs emptying (see page 86).



Perimetric overflow

The overflow safety, present on all Foster sinks, avoids any spillage of water in case the tap is inadvertently left open. The new perimetric solution available on some models improves the look thanks to its squared-out and essential shape.

Space-saver

A feature that optimizes the use of the under-sink space, which is more and more important due to recycling practices. This feature is standard on some models but always possible also on any other model by ordering specific waste fittings and siphons as accessories (see page 86).

How to read the catalogue (sinks chapter)

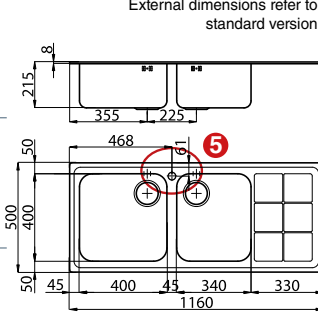
	Features	Version	Ref.	Technical Drawing
Cabinet 90 2 	AISI 304 brushed dimensions: 1160x500 2b: 400x400+340x400 cut-out: 1140x480 drain: 3½"		3 1312 061 (rh) 1312 062 (lh)	External dimensions refer to standard version 
	AISI 304 brushed dimensions: 1173x513 2b: 400x400+340x400 cut-out: 1140x480 drain: 3½"		1318 061 (rh) 1318 062 (lh)	
Accessories: 4 A G L4 L5 M N2 N3 O2 P2 R S T2 T4				



1 Types of installation

Many Foster sinks are available in a variety of versions (Standard, Flush-mount, Flat-edge and Undermount) that can have slightly different dimensions. Therefore we recommend to check the specifications besides every version. The built-in type to which figures are referred is always specified under the drawing.

3 Right-hand, left-hand and reversible sinks

The double code for a single model indicates that both right-hand and left-hand versions are available. The right-hand version (rh) refers to a sink with the bowl (or bigger bowl on models without drainer) on the right. Left-hand versions are identified by the code "lh". The single code indicates that the sink is reversible, or that only the version shown in the picture or drawing is available.

Accessories

A  Chopping board 34x40 8647 000	G  Chopping board 40x40 8646 000	L4  Glass chopping board 23x41 cm 8631 300
---	---	---

4 Accessories

Always striving to blend aesthetics and functionality, Foster devotes special attention to its products' Accessories. This catalogue places special emphasis on the optional features indicated below each model, to facilitate identification of the proper combinations.

2 Cabinet

"Cabinet" refers to the smallest standard element of a modular kitchen in which a sink can be fitted in. In some cases you may find a double standard:

(B) for fitting in top at least 40 mm thick, consider the smaller measure, as indicated in parentheses (e.g. page 23);

(T) for fitting in the beginning/end of composition, consider the bigger measure, as indicated in parentheses.

For special fittings that require extra adaptations to the furniture, please refer to the kitchen manufacturer.

Please note: the listed cabinet sizes refer to the bowls' encumbrance and do to consider the fixing brackets, which can change in any given installation. Please also refer to the kitchen manufacturer's know-how for specific installations which may require some customization on the cabinets.

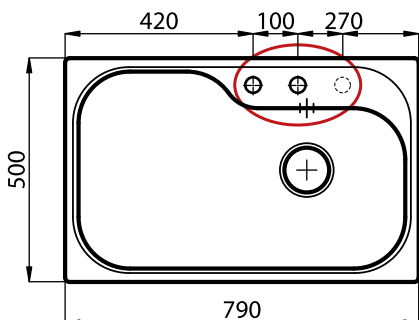
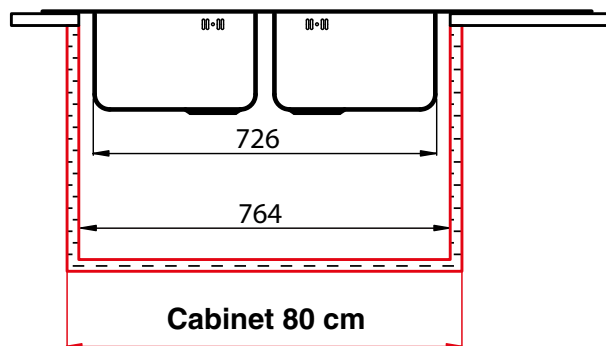

5 Mixer tap holes

In the drawings standard tap holes are shown with continuous line. Further possible holes on request, in order to install the automatic waste fitting and the dispenser, are shown with a dashed line. For some models, customization with additional holes can be done with some extra costs.

Foster Milano **NEW**

AN INNOVATIVE CONCEPT OF FUNCTIONALITY



Three steps system

The Foster Milano sink has an ingenious design that makes it simple to use a large set of optional accessories. On the topmost supporting step, the innovative Black grids slide, creating a large and practical surface to rinse food and crockery.



Complete range of accessories

The second step is meant to support and allow the sliding of a complete combination of accessories, which make some operations practical and safe: rinse, drain, slice, grate... everything can be done inside the sink.



Protection grid on the bottom

The third supporting step is on the bottom of the bowl. On this step one can rest the Black grids, making it possible to rinse foodstuffs without their coming in contact with the bottom of the sink, which may be dirty.

Foster Milano NEW



A large square bowl: all that space that is needed, both as sink and working area.



Thanks to the steps on the edge, the sink can be configured in many different ways.



These steps can accommodate many practical accessories.



The grating kit is a practical element that can be fit into its specific chopping board.



The handy plastic bowls complete the working set.



The stainless steel colander is functional and hygienic.



The ample workspace granted by the Black grids allows to arrange the accessories side by side.



The grids can be placed on the bottom too: more hygiene for food and additional protection for the bowl.



The sink can perform a disappearing act and become a seamless workspace.

Remark: the knives' holder shown in the picture is not supplied with the Foster Milano sinks, but an option on request with surcharge for models with size 1024x560 mm.

accessories



L4
Glass chopping board 23x41 cm
8631 300



M6
Nut wood chopping board 18x44,8 cm
8642 000













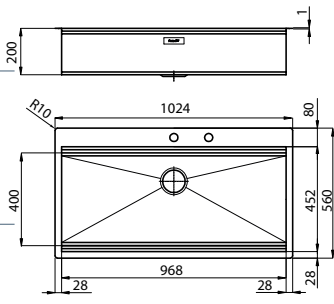

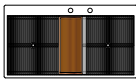



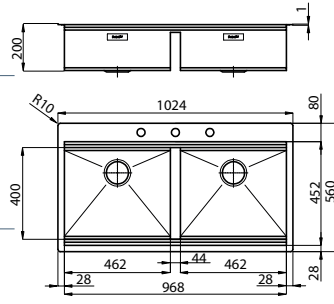

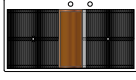
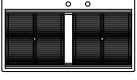
N3
HDPE Twin chopping board 31,7x42,5 cm
8644 101

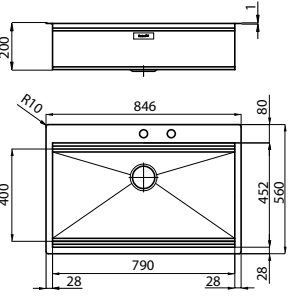

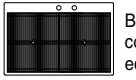
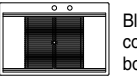
P2 *
Grating kit complete with ring support and food collection tray
8159 101

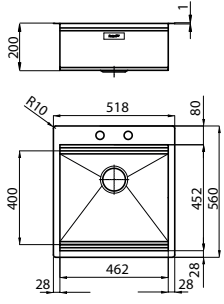
Foster Milano NEW

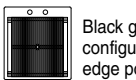
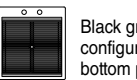
	Features	Version	Ref.	Technical Drawing
	AISI 304 brushed dimensions: 1024x560 1 bowl: 968x400 cut-out: 1004x540 drain: automatic Space Milano (PS) 3½"	 Q4	1018 050	
	AISI 304 brushed dimensions: 1024x560 1 bowl: 968x400 flush-mount (FT): web site up-mount FTS: 1004x540 drain: automatic Space Milano (PS) 3½"	 FT  FTS	1017 050	
Included: PS Optional accessories: M6 P3 L4 N3 P2 T2 Z2	 Black grids configurations edge positioning	 Black grids configurations bottom positioning		
	AISI 304 brushed dimensions: 1024x560 2 bowls: 462x400 cut-out: 1004x540 drain: 2 automatic Space Milano (PS) 3½"	 Q4	1020 050	
	AISI 304 brushed dimensions: 1024x560 2 bowls: 462x400 flush-mount (FT): web site up-mount FTS: 1004x540 drain: 2 automatic Space Milano (PS) 3½"	 FT  FTS	1019 050	
Included: PS Optional accessories: M6 P3 L4 N3 P2 T2 Z2	 Black grids configurations edge positioning	 Black grids configurations bottom positioning		
	AISI 304 brushed dimensions: 846x560 1 bowl: 790x400 cut-out: 826x540 drain: automatic Space Milano (PS) 3½"	 Q4	1025 050	
	AISI 304 brushed dimensions: 846x560 1 bowl: 790x400 flush-mount (FT): web site up-mount FTS: 826x540 drain: automatic Space Milano (PS) 3½"	 FT  FTS	1024 050	
Included: PS Optional accessories: M6 P3 L4 N3 P2 T2 Z2	 Black grids configurations edge positioning	 Black grids configurations bottom positioning		
	AISI 304 brushed dimensions: 518x560 1 bowl: 462x400 cut-out: 498x540 drain: automatic Space Milano (PS) 3½"	 Q4	1012 050	
	AISI 304 brushed dimensions: 518x560 1 bowl: 462x400 flush-mount (FT): web site up-mount FTS: 498x540 drain: automatic Space Milano (PS) 3½"	 FT  FTS	1011 050	
Included: PS Optional accessories: M6 P3 L4 N3 P2 T2 Z2	 Black grids configurations edge positioning	 Black grids configurations bottom positioning		

Standard fittings: fixing brackets, gasket (not available for under-mount sinks), waste fitting, overflow and siphon. Packing: single carton box.



New Wave

SINUOUS ELEGANCE



SPACE drain



Perimetric overflow



Space saver drain

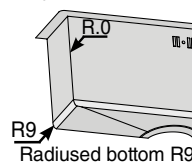

Radiused bottom R9





Play
(8487 000 - pag. 96)





Q Circle
(8469 000 - pag. 95)

suggested mixer taps

	Features	Version	Ref.	Technical Drawing
<p>Cabinet 80</p>  <p>NEW</p> <p>AISI 304 brushed dimensions: 1160x520 2 bowls: 340x400 cut-out: flush-mount (FT): see pack up-mount (FTS): 1148x508 drain: automatic SPACE 3½" PA Perimetric overflow</p>	<p>FT</p> <p>FTS</p>	<p>1420 001 rh</p> <p>1420 002 lh</p>		
<p>Picture shows lh version</p> <p>Accessories: L4 N2 N3 O2 P2 T1 T2 Z2</p>				
<p>Cabinet 80</p>  <p>AISI 304 brushed dimensions: 1160x520 1 bowl: 710x400 cut-out: flush-mount (FT): see pack up-mount (FTS): 1148x508 drain: automatic SPACE 3½" PA Perimetric overflow Space inspectable Siphon</p>	<p>FT</p> <p>FTS</p>	<p>1416 001 rh</p> <p>1416 002 lh</p>		
<p>Picture shows lh version</p> <p>Accessories: L1 L3 L4 N2 N3 O2 P2 S T T1 T2 Z Z2</p>				
<p>Base 60</p>  <p>AISI 304 brushed dimensions: 1160x520 1 bowl: 500x400 cut-out: flush-mount (FT): see pack up-mount (FTS): 1148x508 drain: automatic SPACE 3½" PA Perimetric overflow Space inspectable Siphon</p>	<p>FT</p> <p>FTS</p>	<p>1418 000</p>		
<p>Accessories: L3 L4 N2 N3 O2 P2 S T T1 T2 Z Z2</p>				

Standard fittings: fixing brackets, gasket (not available for under-mount sinks), waste fitting, overflow and siphon. Packing: single carton box.

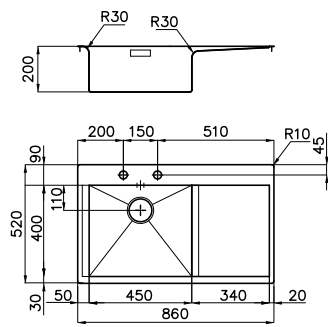

New Wave

	Features	Version	Ref.	Technical Drawing
Cabinet 60	AISI 304 brushed dimensions: 860x520 1 bowl: 450x400 cut-out: flush-mount (FT):  see pack up-mount (FTS): 848x508 drain: automatic SPACE 3½" PA  Perimetric overflow Space inspectable siphon		1414 001 rh	
			1414 002 lh	



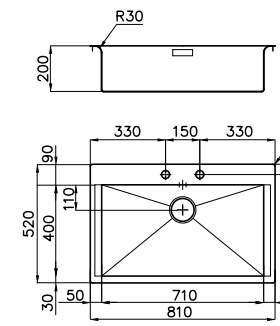

Picture shows lh version

Accessories:
L1 L3 L4 N2 N3 O2 P2 S T T1 T2 Z Z2

Cabinet 80	AISI 304 brushed dimensions: 810x520 1 bowl: 710x400 cut-out: flush-mount (FT):  see pack up-mount (FTS): 798x508 drain: automatic SPACE 3½" PA  Perimetric overflow Space inspectable siphon		1412 000	

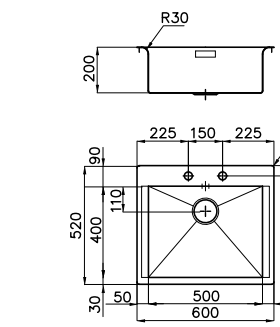

Accessories:
L1 L3 L4 N2 N3 O2 P2 S T T1 T2 Z Z2

Cabinet 60	AISI 304 brushed dimensions: 600x520 1 bowl: 500x400 cut-out: flush-mount (FT):  see pack up-mount (FTS): 588x508 drain: automatic SPACE 3½" PA  Perimetric overflow Space inspectable siphon		1410 000	



Accessories:
L1 L3 L4 N2 N3 O2 P2 S T T1 T2 Z Z2

Standard fittings: fixing brackets, gasket (not available for under-mount sinks), waste fitting, overflow and siphon. Packing: single carton box.



Distinctive design
 The distinctive design of the New Wave drainer, with its refined and ample bend that facilitates the flow of water into the bowl.















Space waste-fitting
 The "Space" waste-fitting with steel cap gives elegance to the bowl and hides any residue collected in the underlying basket.



Siphon supplied
 The Space siphon supplied with the sink can be opened for inspection and leaves all the necessary space to install waste-sorting systems.

accessories

 L3 Twin chopping board 41x41 cm 8644 004	 L4 Glass chopping board 23x41 cm 8631 300	 N2 HDPE chopping board 27,2x42,5 cm 8657 001	 N3 HDPE Twin chopping board 31,7x42,5 cm 8644 101
 O2 White plastic bowl 27,2x41,4 cm 8153 100	 P2 ** Grating kit complete with ring support and food collection tray 8159 101	 S St. steel basket 40x40 8612 000 White basket 40x40 8612 100	 T * St. steel dishes holder 25x35 cm 8100 154
 T1 St. steel dishes holder 25x42,5 cm 8100 201	 T2 ** St. steel dishes holder 21,4x37,9 cm 8100 303	 Z * St. steel colander 25x36 cm 8154 000	 Z2 ** St. steel perforated pan 21,5x38 cm 8151 000

*To use only with L3 chopping board **To use only with N3 chopping board

GK

ESSENTIAL YET REFINED



GK
(8488 000 - pag. 95)

suggested mixer taps



SPACE drain



Perimetric overflow













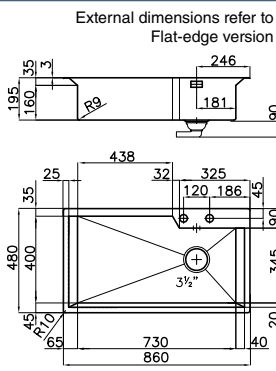



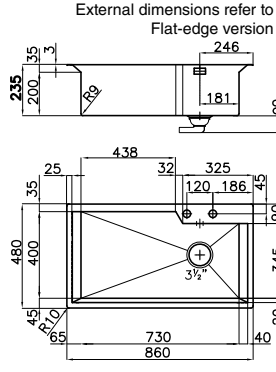

Space saver drain

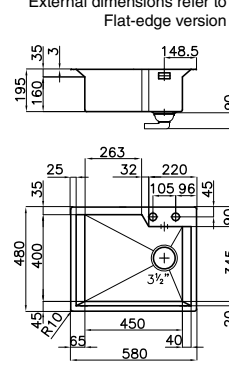

Vintage Finish

NEW

	Features	Version	Ref.	Technical Drawing	
Cabinet 90 	AISI 304 brushed bowl depth: 195 mm dimensions: 860x480 cut-out: 847x467 drain: autom. SPACE 3½" PA	 SF	1401 100	External dimensions refer to Flat-edge version 	
		AISI 304 brushed bowl depth: 195 mm dimensions: 860x480 cut-out: flush-mount (FT): web site up-mount (FTS): 847x467 drain: autom. SPACE 3½" PA	 FT  FTS		1401 000
Included: PA Optional accessories: M4 N4 T2 P2 Z2					
Cabinet 90 	AISI 304 brushed bowl depth: 235 mm dimensions: 860x480 cut-out: 847x467 drain: autom. SPACE 3½" PA	 SF	1402 100	External dimensions refer to Flat-edge version 	
		AISI 304 brushed bowl depth: 235 mm dimensions: 860x480 cut-out: flush-mount (FT): web site up-mount (FTS): 847x467 drain: autom. SPACE 3½" PA	 FT  FTS		1402 000
		vintage version 	 FT  FTS		1402 080
Included: PA Optional accessories: M4 N4 T2 P2 Z2					
Cabinet 60 	AISI 304 brushed bowl depth: 195 mm dimensions: 580x480 cut-out: 567x467 drain: autom. SPACE 3½" PA	 SF	1403 100	External dimensions refer to Flat-edge version 	
		AISI 304 brushed bowl depth: 195 mm dimensions: 580x480 cut-out: flush-mount (FT): web site up-mount (FTS): 567x467 drain: autom. SPACE 3½" PA	 FT  FTS		1403 000
Included: PA Optional accessories: M4 N4 T2 P2 Z2					

Standard fittings: fixing brackets, gasket (not available for under-mount sinks), waste fitting, overflow and siphon. Packing: single carton box.

GK

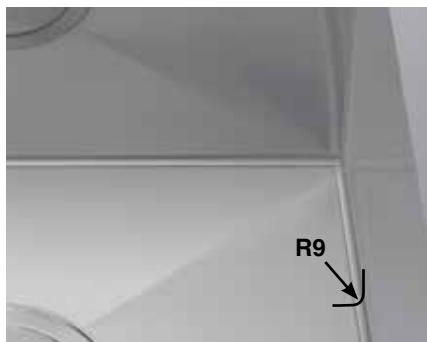

Different edges for better hygiene

The squared vertical edges match to the soft bottom practical and hygienic ones. The diamond design on the bottom is a touch of refinement ensuring the optimal water flow.



Remote control

In the flush-mount and flat-edge models, a remote control to open the drain without dipping hands into the bowl is also included.



Elegant SPACE drain

The elegant SPACE steel cap, included in all models, closes the drain and leaves no visible residues collected in the basket below.



Space-saving drain and siphon

The GK sinks are equipped with space-saving drain and siphon allowing the optimal use of the under-sink space.



Perimetral Overflow

The attention to detail and the minimalist design can also be found in the original perimetric overflow that enhances the bowl.



Practical inclined containing area

The inclined containing area is the jointing element between sink and hob, creating a classy combination, functional in use and in surfaces cleaning.

An original set of accesoires

For all the GK models a complete set of optional accessories is available. These fit perfectly in the spacious bowl and transform the sink in a complete and functional working area for the preparation and washing of food.



accessories



M4

Iroko chopping board
8656 001



N4

HDPE Twin chopping board
8644 100



T2

St. steel dishes holder
25x42,5 cm
8100 303



P2

Grating kit complete with ring support and food collection bowl
8159 101



Z2

St. steel perforated pan
8151 000

S4001

AN ICON OF STYLE AND FUNCTIONALITY



SPACE drain



Perimetric overflow









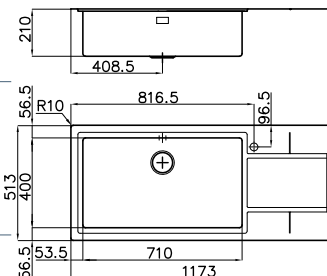

Space saver drain

Q Circle Colour
(8469 040 - pag. 95)

Camillo
(8467 000 - pag. 97)

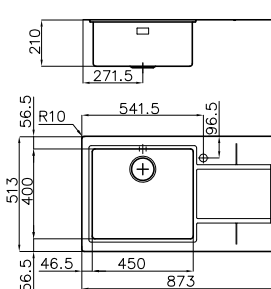
suggested mixer taps

	Features	Version	Ref.	Technical Drawing
Cabinet 90  <i>Picture shows lh version</i>	AISI 304 brushed dimensions: 1160x500 1 bowl: 710x400 cut-out: 1140x480 drain: SPACE 3½"	 Q4	4416 061 rh 4416 062 lh	External dimensions refer to Flush-mount version 
		 FT  FTS	4417 061 rh 4417 062 lh	
Cabinet 60  <i>Picture shows lh version</i>	AISI 304 brushed dimensions: 860x500 1 bowl: 450x400 cut-out: 840x480 drain: SPACE 3½"	 Q4	4483 061 rh 4483 062 lh	External dimensions refer to Flush-mount version 
		 FT  FTS	4486 061 rh 4486 062 lh	

Accessories:

L1 L3 L4 N2 N3 O2 P2 S T1 T2 Z Z2

For Q4 version only: L5 M (page 20)

Accessories:

L1 L3 L4 N2 N3 O2 P2 S T1 T2 Z Z2

For Q4 version only: L5 M (page 20)

Standard fittings: fixing brackets, gasket (not available for under-mount sinks), waste fitting, overflow and siphon. Packing: single carton box.



S4001

ESSENTIAL QUALITY



SPACE drain



Perimetric overflow





Space saver drain

suggested mixer taps

	Features	Version	Ref.	Technical Drawing
--	----------	---------	------	-------------------

Cabinet 80



AISI 304 brushed
 dimensions: **760x450**
 1 bowl: **710x400**
 cut-out: flush-mount (FT):  **3127 060**
 web site 
 up-mount (FTS): 751x441 
 drain: SPACE 3/2"

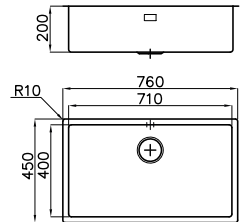



Accessories: (page 20)

L1 L3 L4 N2 N3 O2 P2 S T T1 T2 Z Z2

Automatic waste fitting: **PA PE PM** (page 86)

Cabinet 60



AISI 304 brushed
 dimensions: **550x450**
 1 bowl: **500x400**
 cut-out: flush-mount (FT):  **3125 060**
 web site 
 up-mount (FTS): 541x441 
 drain: SPACE 3/2"

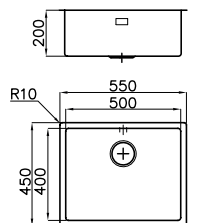



Accessories: (page 20)

L1 L3 L4 N2 N3 O2 P2 S T T1 T2 Z Z2

Automatic waste fitting: **PA PE PM** (page 86)

Cabinet 60



AISI 304 brushed
 dimensions: **500x450**
 1 bowl: **450x400**
 cut-out: flush-mount (FT):  **3124 060**
 web site 
 up-mount (FTS): 491x441 
 drain: SPACE 3/2"

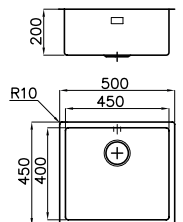









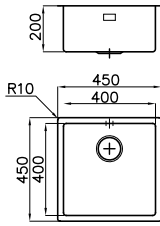

Accessories: (page 20)

L1 L3 L4 N2 N3 O2 P2 S T T1 T2 Z Z2

Automatic waste fitting: **PA PE PM** (page 86)

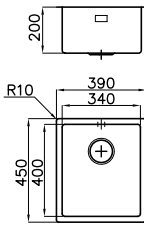
Standard fittings: fixing brackets, gasket (not available for under-mount sinks), waste fitting, overflow and siphon. Packing: single carton box.



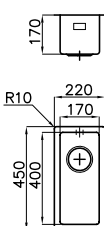





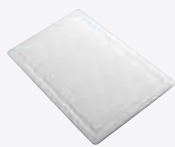

S4001

	Features	Version	Ref.	Technical Drawing
Cabinet 45 	AISI 304 brushed dimensions: 450x450 1 bowl: 400x400 cut-out: flush-mount (FT): web site up-mount (FTS): 441x441 drain: SPACE 3½"	 	3126 060	
Accessories: L1 L3 L4 N2 N3 O2 P2 S T T1 T2 Z Z2 Automatic waste fitting: PA PE PM (page 86)				
Cabinet 40 	AISI 304 brushed dimensions: 390x450 1 bowl: 340x400 cut-out: flush-mount (FT): web site up-mount (FTS): 381x441 drain: SPACE 3½"	 	3123 060	
Accessories: L1 L4 N2 N3 O2 P2 R T1 T2 Z2 Automatic waste fitting: PA PE PM (page 86)				
Cabinet 30 	AISI 304 brushed dimensions: 220x450 1 bowl: 170x400 cut-out: flush-mount (FT): web site up-mount (FTS): 211x441 drain: SPACE 3½"	 	3121 060	
Automatic waste fitting: PA PE PM (page 86)				

Standard fittings: fixing brackets, gasket (not available for under-mount sinks), waste fitting, overflow and siphon. Packing: single carton box.

accessories

L1 L5 R T2 ** p. 26

 <p>L3 Twin chopping board 41x41 cm 8644 004</p>	 <p>L4 Glass chopping board 23x41 cm 8631 300</p>	 <p>M Sliding chopping board 30x54 8643 000</p>	 <p>N2 HDPE chopping board 27,2x42,5 cm 8657 001</p>
 <p>N3 HDPE Twin chopping board 31,7x42,5 8644 101</p>	 <p>O2 White plastic bowl 27,2x41,4 cm 8153 100</p>	 <p>P2 ** Grating kit complete with ring support and food collection tray 8159 101</p>	 <p>S St. steel basket 40x40 8612 000</p> <p>White basket 40x40 8612 100</p>
 <p>T * St. steel dishes holder 25x35 cm 8100 154</p>	 <p>T1 St. steel dishes holder 25x42,5 cm 8100 201</p>	 <p>Z * St. steel colander 25x36 cm 8154 000</p>	 <p>Z2 ** St. steel perforated pan 21,5x38 cm 8151 000</p>

*To use only with L3 chopping board **To use only with N3 chopping board

S4000

A DISTINCTIVE DESIGN















Perimetric overflow

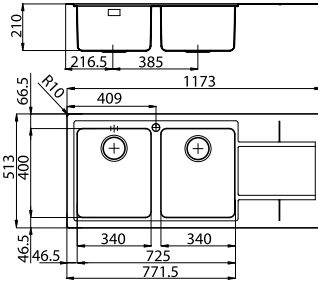

Play
(8487 000 - pag. 96)

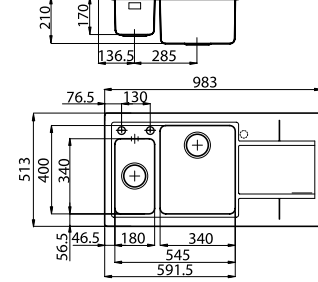



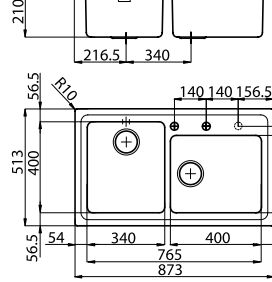

Camillo
(8467 000 - pag. 97)

	Features	Version	Ref.	Technical Drawing
<p>Cabinet 80</p>  <p>Picture shows lh version</p> <p>Accessories: L1 L4 N2 N3 O2 P2 R T1 T2 Z2 For Q4 version only: L5 M</p>	<p>AISI 304 brushed dimensions: 1160x500 2 bowls: 340x400 cut-out: 1140x480 drain: 3½"</p> <p>AISI 304 brushed dimensions: 1173x513 2 bowls: 340x400 cut-out: flush-mount (FT): web site up-mount (FTS): 1160x500 drain: 3½"</p>	<p> Q4</p> <p> FT</p> <p> FTS</p>	<p>4312 051 rh 4312 052 lh</p> <p>4315 051 rh 4315 052 lh</p>	<p>External dimensions refer to Flush-mount version</p> 
<p>Cabinet 60(80)^T (ref. page 10)</p>  <p>Picture shows lh version</p> <p>Item available until stock lasts</p> <p>Accessories: L1 L4 N2 N3 O2 P2 R T1 T2 Z2 For Q4 version only: L5 M</p>	<p>AISI 304 brushed dimensions: 983x513 2b: 180x340+340x400 cut-out: flush-mount (FT): web site up-mount (FTS): 970x500 automatic drain 3½" PM</p>	<p> FT</p> <p> FTS</p>	<p>4365 051 rh 4365 052 lh</p>	<p>External dimensions refer to Flush-mount version</p>  <p>Third tap hole available</p>
<p>Cabinet 90</p>  <p>Accessories: L1 L4 N2 N3 O2 P2 R T1 T2 Z2 For Q4 version only: L5 M</p>	<p>AISI 304 brushed dimensions: 860x500 2b: 340x400+400x340 cut-out: 840x480 automatic drain 3½" PM</p> <p>AISI 304 brushed dimensions: 873x513 2b: 340x400+400x340 cut-out: flush-mount (FT): web site up-mount (FTS): 860x500 automatic drain 3½" PM</p>	<p> Q4</p> <p> FT</p> <p> FTS</p>	<p>4382 050</p> <p>4385 050</p>	<p>External dimensions refer to Flush-mount version</p>  <p>Third tap hole available</p>

Standard fittings: fixing brackets, gasket (not available for under-mount sinks), waste fitting, overflow and siphon. Packing: single carton box.

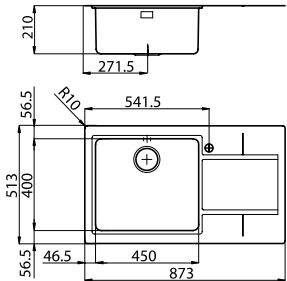
S4000

	Features	Version	Ref.	Technical Drawing
Cabinet 60  <i>Picture shows lh version</i>	AISI 304 brushed dimensions: 860x500 1 bowl: 450x400 cut-out: 840x480 drain: 3/2"	 Q4	4383 051 rh 4383 052 lh	External dimensions refer to Flush-mount version 
		AISI 304 brushed dimensions: 873x513 1 bowl: 450x400 cut-out: flush-mount (FT): web site up-mount (FTS): 860x500 drain: 3/2"	 FT  FTS	
Accessories: L1 L3 L4 N2 N3 O2 P2 S T T1 T2 Z Z2 For Q4 version only: L5 M				











Standard fittings: fixing brackets, gasket (not available for under-mount sinks), waste fitting, overflow and siphon. Packing: single carton box.

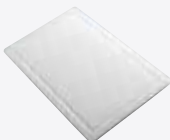

Two sloped "grooves" are carved into the drainig board. Minimalism and functionality.

accessories

L1 L5 R T2 ** p. 26

 <p>L3 Twin chopping board 41x41 cm 8644 004</p>	 <p>L4 Glass chopping board 23x41 cm 8631 300</p>	 <p>M Sliding chopping board 30x54 8643 000</p>	 <p>N2 HDPE chopping board 27,2x42,5 cm 8657 001</p>
 <p>N3 HDPE Twin chopping board 31,7x42,5 8644 101</p>	 <p>O2 White plastic bowl 27,2x41,4 cm 8153 100</p>	 <p>P2 ** Grating kit complete with ring support and food collection tray 8159 101</p>	 <p>S St. steel basket 40x40 8612 000 White basket 40x40 8612 100</p>
 <p>T * St. steel dishes holder 25x35 cm 8100 154</p>	 <p>T1 St. steel dishes holder 25x42,5 cm 8100 201</p>	 <p>Z * St. steel colander 25x36 cm 8154 000</p>	 <p>Z2 ** St. steel perforated pan 21,5x38 cm 8151 000</p>

*To use only with L3 chopping board **To use only with N3 chopping board

Quadra

THE FORMAL PERFECTION



Perimetric overflow

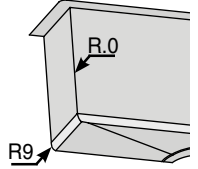

Radiused bottom R9

Tre Alto
(8468 000 - pag. 98)



Q Circle
(8469 000 - pag. 95)

suggested mixer taps

	Features	Version	Ref.	Technical Drawing
--	----------	---------	------	-------------------

Cabinet (60)³/120 (ref. page 10)



AISI 304 brushed dimensions: **1064x464**
 1 bowl: **470x400**
 cut-out: flush-mount (FT):  **1210 050**
 web site
 up-mount (FTS):  1047x447
 drain: 3½"

External dimensions refer to Flat-edge version

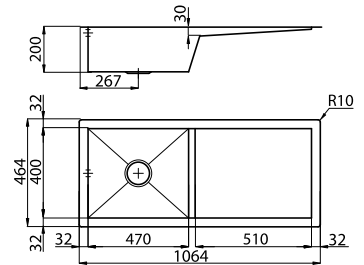

Accessories: (page 26)

L1 L3 L4 N2 N3 O2 P2 S T T1 T2 Z Z2

Automatic waste fitting: **PA PE PM** (page 86)

Cabinet (60)³/90 (ref. page 10)



Picture shows rh version

AISI 304 brushed dimensions: **1000x510**
 1 bowl: **470x400**
 cut-out: 980x495
 drain: **automatic 3½"** PM 

External dimensions refer to Flat-edge version

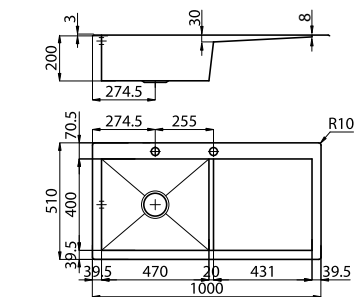



Accessories: (page 26)

L1 L3 L4 N2 N3 O2 P2 S T T1 T2 Z Z2

Cabinet (80)³/120 (ref. page 10)



AISI 304 brushed dimensions: **1000x440**
 1 bowl: **675x400**
 cut-out: flush-mount (FT):  **1220 050**
 web site
 up-mount (FTS):  987x427
 drain: 3½"

External dimensions refer to Flat-edge version

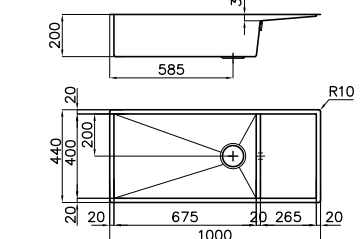

Accessories: (page 26)

L1 L3 L4 N2 N3 O2 P2 S T T1 T2 Z Z2

Automatic waste fitting: **PA PE PM** (page 86)

Standard fittings: fixing brackets, gasket (not available for under-mount sinks), waste fitting, overflow and siphon. Packing: single carton box.

Quadra

Features	Version	Ref.	Technical Drawing
----------	---------	------	-------------------

Cabinet (80)⁹/120 (ref. page 10)

NEW

AISI 304 brushed
 dimensions: **1160x502**
 2 bowls: **340x400**
 cut-out: flush-mount (FT):
 web site
 up-mount (FTS): 1143x485
 drain: **automatic 3½" PM**

FT

1228 051 rh

1228 052 lh



Picture shows lh version

Accessories: (page 26)

L1 L4 N2 N3 O2 P2 R T1 T2 Z2

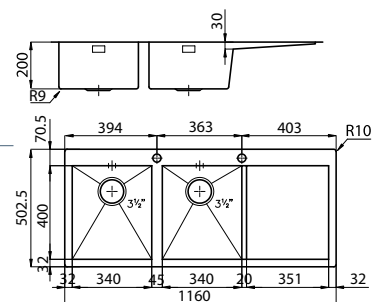

Cabinet 90

AISI 304 brushed
 dimensions: **864x464**
 1 bowl: **800x400**
 cut-out: flush-mount
 (FT): web site
 up-mount (FTS): 847x447
 drain: 3½"

FT

1218 050

FTS

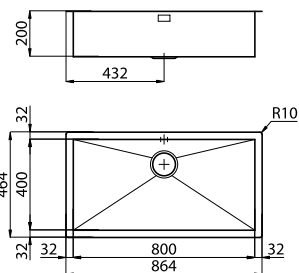

Accessories: (page 26)

L1 L3 L4 N2 N3 O2 P2 S T T1 T2 Z Z2

Automatic waste fitting: PA PE PM (page 86)

Cabinet 90

AISI 304 brushed
 dimensions: **840x510**
 1 bowl: **761x400**
 cut-out: 820x495
 drain: **automatic 3½" PM**

SF

1219 050

AISI 304 brushed
 dimensions: **825x503**
 1 bowl: **761x400**
 cut-out: flush-mount (FT):
 web site
 up-mount (FTS): 808x486
 drain: **automatic 3½" PM**

FT

1229 050

FTS



External dimensions refer to Flat-edge version

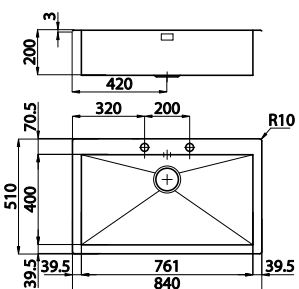

Accessories: (page 26)

L1 L3 L4 N2 N3 O2 P2 S T T1 T2 Z Z2

Cabinet 90

AISI 304 brushed
 dimensions: **839x479**
 bowl: **710x400**
 cut-out: 819x459
 drain: **automatic 3½" PM**

SF

1250 050

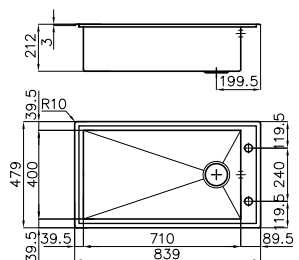

Accessories: (page 26)

L1 L3 L4 N2 N3 O2 P2 S T T1 T2 Z Z2

Cabinet 80

AISI 304 brushed
 dimensions: **804x510**
 2 bowls: **340x400**
 cut-out: 784x495
 drain: 3½"

SF

1209 050

AISI 304 brushed
 dimensions: **789x503**
 2 bowls: **340x400**
 cut-out: flush-mount (FT):
 web site
 up-mount (FTS): 772x486
 drain: 3½"

FT

1208 050

FTS



External dimensions refer to Flat-edge version

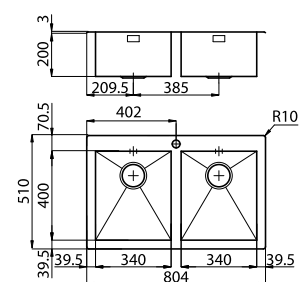

Accessories: (page 26)

L1 L4 N2 N3 O2 P2 R T1 T2 Z2

Standard fittings: fixing brackets, gasket (not available for under-mount sinks), waste fitting, overflow and siphon. Packing: single carton box.

Quadra

	Features	Version	Ref.			Technical Drawing
--	----------	---------	------	--	--	-------------------

Cabinet (40)³/60 (ref. page 10)



Picture shows lh version

AISI 304 brushed
dimensions: **600x520**
1 bowl: **270x400**
cut-out: 580x500
drain: **automatic 3½"** PR
standard overflow



1246 091 rh
1246 092 lh

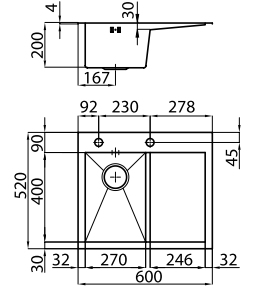

Accessories: **L4 N2 O2 T1** (page 26)

Cabinet 60



AISI 304 brushed
dimensions: **560x520**
1 bowl: **500x400**
cut-out: 540x500
automatic drain 3½" PM



1243 050

AISI 304 brushed
dimensions: **579x510**
1 bowl: **500x400**
cut-out: 559x495
automatic drain 3½" PM



1216 050

External dimensions refer to Q4 version

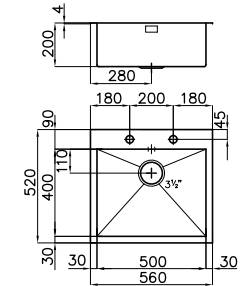

Accessories: (page 26)

L1 L3 L4 N2 N3 O2 P2 S T T1 T2 Z Z2

Cabinet 60



AISI 304 brushed
dimensions: **564x464**
1 bowl: **500x400**
cut-out: flush-mount (FT):
web site
up-mount (FTS): 547x447
drain: 3½"



1215 050

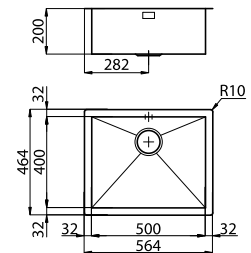

Accessories: (page 26)

L1 L3 L4 N2 N3 O2 P2 S T T1 T2 Z Z2

Automatic waste fitting: **PA PE PM** (page 86)

Cabinet 45



AISI 304 brushed
dimensions: **479x510**
1 bowl: **400x400**
cut-out: 459x495
automatic drain 3½" PM



1205 050

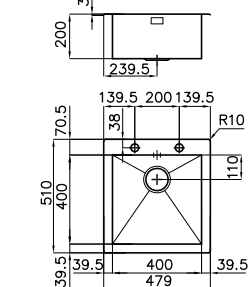

Accessories: (page 26)

L1 L3 L4 N2 N3 O2 P2 S T T1 T2 Z Z2

Cabinet 45



AISI 304 brushed
dimensions: **464x464**
1 bowl: **400x400**
cut-out: flush-mount (FT):
web site
up-mount (FTS): 447x447
drain: 3½"



1214 050

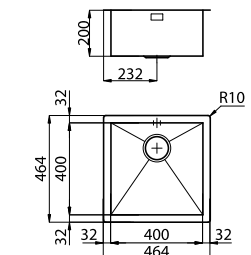

Accessories: (page 26)

L1 L3 L4 N2 N3 O2 P2 S T T1 T2 Z Z2

Automatic waste fitting: **PA PE PM** (page 86)

Standard fittings: fixing brackets, gasket (not available for under-mount sinks), waste fitting, overflow and siphon. Packing: single carton box.

Quadra 7"

Features	Version	Ref.	Technical Drawing
----------	---------	------	-------------------

Cabinet 40



AISI 304 brushed
 dimensions: **400x520**
 1 bowl: **340x400**
 cut-out: 380x500
 drain: **automatic 3½" PM**



1241 050

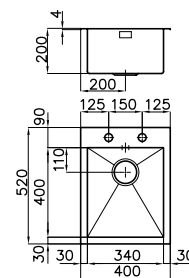

Accessories:

L1 L4 N2 N3 O2 P2 T1 T2 Z2

Cabinet 90



AISI 304 brushed
 dimensions: **864x464**
 1 bowl: **800x400**
 cut-out: flush-mount (FT):
 web site
 up-mount (FTS): 847x447
 drain: 7"



1218 097

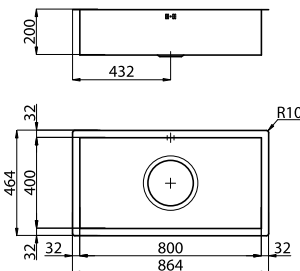

Accessories: **L3 L4 N2 O2 S T T1 Z**

Available also in undermount version, see page 67

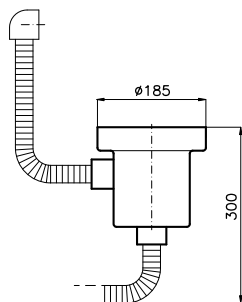

Extralarge waste fitting

The 7" waste fitting features a bigger dimension than standard ones. The drain offers a large and deep basket for food waste collection.



Standard fittings: fixing brackets, gasket (not available for under-mount sinks), 7" waste fitting/siphon, overflow. Packing: single carton box.

accessories

 <p>L1 Twin chopping board 31,7x42,5 cm 8644 041</p>	 <p>L3 Twin chopping board 41x41 cm 8644 004</p>	 <p>L4 Glass chopping board 23x41 cm 8631 300</p>	 <p>L5 Glass chopping board 29x54 cm 8633 300</p>
 <p>M Sliding chopping board 30x54 8643 000</p>	 <p>N2 HDPE chopping board 27,2x42,5 cm 8657 001</p>	 <p>N3 HDPE Twin chopping board 31,7x42,5 cm 8644 101</p>	 <p>O2 White plastic bowl 27,2x41,4 cm 8153 100</p>
 <p>P2 ** Grating kit complete with ring support and food collection tray 8159 101</p>	 <p>R St. steel basket 34x40 8611 000</p>	 <p>S St. steel basket 40x40 8612 000 White basket 40x40 8612 100</p>	 <p>T * St. steel dishes holder 25x35 cm 8100 154</p>
 <p>T1 St. steel dishes holder 25x42,5 cm 8100 201</p>	 <p>T2 ** St. steel dishes holder 21,4x37,9 cm 8100 303</p>	 <p>Z * St. steel colander 25x36 cm 8154 000</p>	 <p>Z2 ** St. steel perforated pan 21,5x38 cm 8151 000</p>

*To use only with L3 chopping board **To use only with N3 chopping board

CQ NEW

DESIGN GOES AROUND

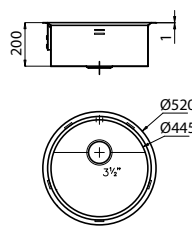

suggested mixer taps

	Features	Version	Ref.	Technical Drawing
Cabinet 60 	AISI 304 brushed dimensions: Ø 520 1 bowl: Ø 445 cut-out: flush-mount (FT): web site up-mount (FTS): Ø 500 drain: SPACE 3½"	FT FTS	1222 000	

Accessories: **P5** **T6** **P6**

Standard fittings: fixing brackets, gasket (not available for under-mount sinks), waste fitting, overflow and siphon. Packing: single carton box.

Unconventional accessories

The CQ sink is complimented by an original set of accessories. The compact kit with chopping board, steel grid and colander makes any work much easier, while the Black grid closes the sink, transforming it into a practical work area.



accessori



P5
Black grid for CQ
8154 600



T6
St. steel dishes
holder
8100 051



P6
Kit composed by steel grid +
colander + chopping board
8100 151

Master

PURE FUNCTIONAL ELEGANCE



Perimetric overflow



Master
(8493 000 - pag. 98)



Q Circle Plus
(8469 020 - pag. 95)



suggested mixer taps

	Features	Version	Ref.	Technical Drawing
--	----------	---------	------	-------------------

Cabinet 80



Picture shows lh version

AISI 304 brushed
dimensions: **1160x520**
2 bowls: **340x400**
cut-out: flush-mount (FT):  **1252 051 rh**
web site **1252 052 lh**
up-mount (FTS):  1147x507
drain: **automatic 3½" PM**

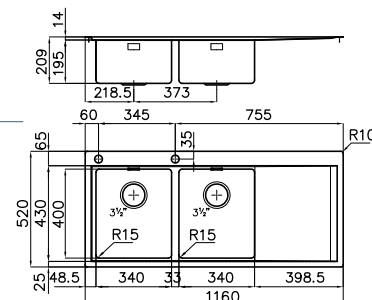



Accessories: (page 26)

L1 L4 L5 N2 N3 O2 P2 R T1 T2 Z2

Cabinet 60



Picture shows lh version

AISI 304 brushed
dimensions: **1000x520**
2 b.: **340x400 + 180x400**
cut-out: flush-mount (FT):  **1251 051 rh**
web site **1251 052 lh**
up-mount (FTS):  987x507
drain: **automatic 3½" PM**

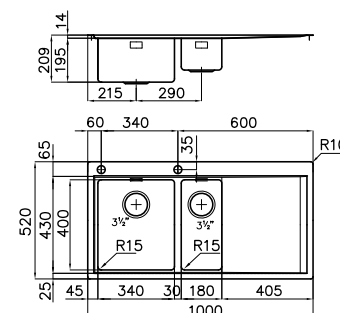



Accessories: (page 26)

L1 L3 L4 L5 N2 N3 O2 P2 S T T2 Z Z2

Cabinet 60



Picture shows lh version

AISI 304 brushed
dimensions: **860x520**
1 bowl: **450x400**
cut-out: flush-mount (FT):  **1250 051 rh**
web site **1250 052 lh**
up-mount (FTS):  847x507
drain: **automatic 3½" PM**

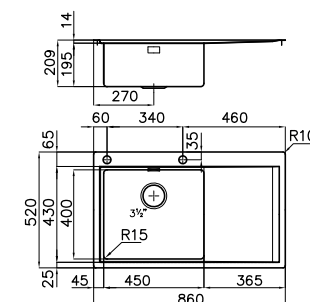

Accessories: (page 26)

L1 L3 L4 L5 N2 N3 O2 P2 S T T2 Z Z2







Standard fittings: fixing brackets, gasket (not available for under-mount sinks), waste fitting, overflow and siphon. Packing: single carton box.

FL

A MULTIFUNCTIONAL SINGLE BOWL

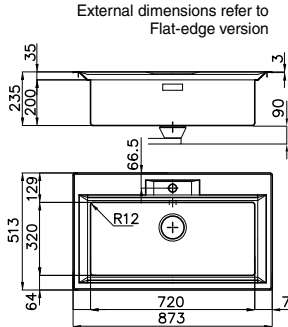

suggested mixer taps

	Features	Version	Ref.	Technical Drawing
Cabinet 80 	AISI 304 brushed dimensions: 860x500 bowl: 720x320 cut-out: 840x480 drain: 3½"	 STD	2975 060	External dimensions refer to Flat-edge version 
	AISI 304 brushed dimensions: 873x513 bowl: 720x320 cut-out: 840x480 drain: 3½"	 SF	2976 060	
	AISI 304 brushed dimensions: 873x513 bowl: 720x320 flush-mount (FT): web site up-mount (FTS): 860x500 drain: 3½"	 FT  FTS	2977 060	
Accessories: M5 T5				

Standard fittings: fixing brackets, gasket (not available for under-mount sinks), waste fitting, overflow and siphon. Packing: single carton box.

accessories

Stackable accessories



M5
Sliding iroko
chopping board
33,2x38,4 cm
8659 113

T5
St. steel dishes
holder
21,4x33,1 cm
8100 304

The characteristic shape of the bowl creates two lanes on which slide independently the cutting board and the drip grid. A flexible, complete and compact working set.



KE

QUALITY OF FORM AND SUBSTANCE



Perimetric overflow









Tre Alto
(8468 000 - pag. 98)



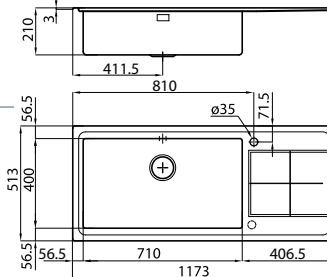

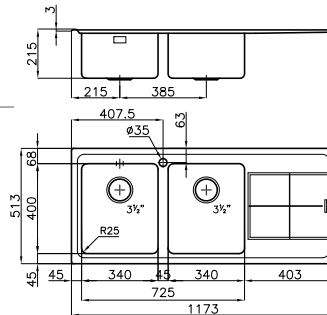

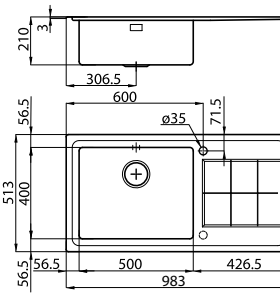



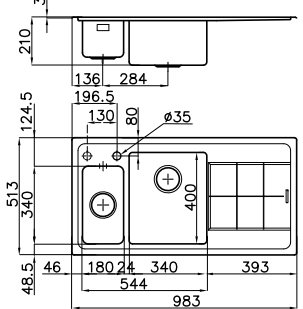

KE
(8492 000 - pag. 99)

suggested mixer taps

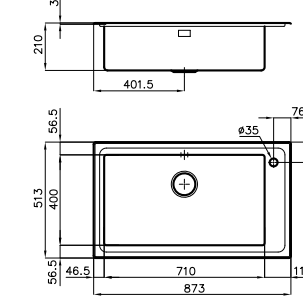
	Features	Version	Ref.	Technical Drawing
<p>Cabinet 90</p>  <p>Picture shows lh version</p> <p>Accessories: L1 L3 L4 L5 M N2 N3 O2 P2 S T T1 T2 Z Z2 (page 32) Automatic waste fitting: PA PE PM (page 86)</p>	<p>AISI 304 brushed dimensions: 1173x513 1 bowl: 710x400 cut-out: 1140x480 drain: 3½"</p>		<p>2211 051 rh 2211 052 lh</p>	 <p>Second tap hole available</p>
<p>Cabinet 90</p>  <p>Picture shows lh version</p> <p>Accessories: L1 L4 N2 N3 O2 P2 R T1 T2 Z2</p>	<p>NEW AISI 304 brushed dimensions: 1173x513 2 bowls: 340x400 cut-out: 1140x480 drain: 3½"</p>		<p>2222 051 dx 2222 052 sx</p>	 <p>Second tap hole available</p>
<p>Cabinet 80</p>  <p>Picture shows lh version</p> <p>Accessories: L1 L3 L4 L5 M N2 N3 O2 P2 S T T1 T2 Z Z2 (page 32) Automatic waste fitting: PA PE PM (page 86)</p>	<p>AISI 304 brushed dimensions: 983x513 1 bowl: 500x400 cut-out: 950x480 drain: 3½"</p>		<p>2263 051 rh 2263 052 lh</p>	 <p>Second tap hole available</p>

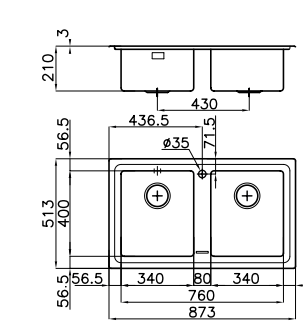

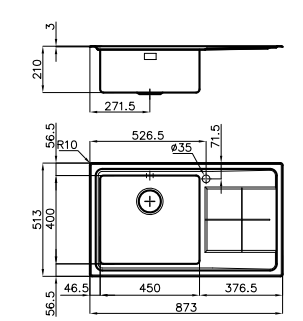

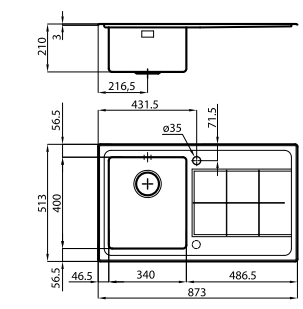

Standard fittings: fixing brackets, gasket (not available for under-mount sinks), waste fitting, overflow and siphon. Packing: single carton box.

KE

	Features	Version	Ref.	Technical Drawing
<p>Cabinet 60(80)^T (ref. page 10)</p>  <p>Picture shows lh version</p> <p>Accessories: (page 32) L1 L4 L5 M N2 N3 O2 P2 R T1 T2 Z2</p> <p>Automatic waste fitting: PA PE PM (page 86)</p>	<p>AISI 304 brushed dimensions: 983x513 2b: 180x340+340x400 cut-out: 950x480 drain: 3/2"</p>		<p>2297 051 rh 2297 052 lh</p>	 <p>Second tap hole available</p>
<p>Cabinet 80</p>  <p>Accessories: (page 32) L1 L4 L5 M N2 N3 O2 P2 S T1 T2 Z2</p>	<p>AISI 304 brushed dimensions: 873x513 1 bowl: 710x400 cut-out: 840x480 drain: 3/2"</p>		<p>2287 050</p>	
<p>Cabinet 80(90)^T (ref. page 10)</p>  <p>Accessories: (page 32) L1 L4 L5 M N2 N3 O2 P2 R T1 T2 Z2</p>	<p>AISI 304 brushed dimensions: 873x513 2b: 340x400 cut-out: 840x480 drain: 3/2"</p>		<p>2283 050</p>	
<p>Cabinet 60</p>  <p>Picture shows lh version</p> <p>Accessories: L1 L3 L4 L5 M N2 N3 O2 P2 S T T1 T2 Z Z2 (page 32)</p>	<p>AISI 304 brushed dimensions: 873x513 1 bowl: 450x400 cut-out: 840x480 drain: 3/2"</p>		<p>2280 051 rh 2280 052 lh</p>	
<p>Cabinet 45(60)^T (ref. page 10)</p>  <p>Picture shows lh version</p> <p>Accessories: (page 32) L1 L4 L5 M N2 N3 O2 P2 R T1 T2 Z2</p> <p>Automatic waste fitting: PA PE PM (page 86)</p>	<p>AISI 304 brushed dimensions: 873x513 1 bowl: 340x400 cut-out: 840x480 drain: 3/2"</p>		<p>2281 051 rh 2281 052 lh</p>	 <p>Second tap hole available</p>

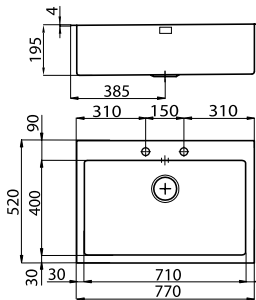
Standard fittings: fixing brackets, gasket (not available for under-mount sinks), waste fitting, overflow and siphon. Packing: single carton box.

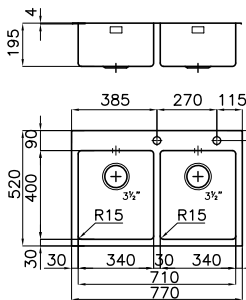

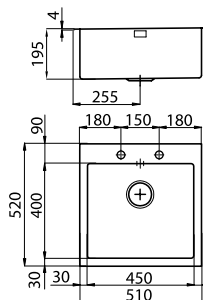







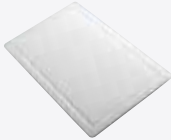

KE Q4

	Features	Version	Ref.	Technical Drawing
<p>Cabinet 80</p> 	<p>AISI 304 brushed dimensions: 770x520 1 bowl: 710x400 cut-out: 750x500 drain: automatic 3½" PM</p>		2278 050	
<p>Accessories: L1 L3 L4 N2 N3 O2 P2 S T T1 T2 Z Z2</p>				
<p>Cabinet 80</p> 	<p>AISI 304 brushed dimensions: 770x520 2 bowls: 340x400 cut-out: 750x500 drain: automatic 3½" PM</p>		2279 050	
<p>Accessories: L1 N2 N3 O2 P2 S T1 T2 Z2</p>				
<p>Cabinet 60</p> 	<p>AISI 304 brushed dimensions: 510x520 1 bowl: 450x400 cut-out: 490x500 drain: automatic 3½" PM</p>		2274 050	
<p>Accessories: L1 L3 L4 N2 N3 O2 P2 S T T1 T2 Z Z2</p>				

Standard fittings: fixing brackets, gasket (not available for under-mount sinks), waste fitting, overflow and siphon. Packing: single carton box.

accessories

L1 R T* Z2** p. 26

 <p>L3 Twin chopping board 41x41 cm 8644 004</p>	 <p>L4 Glass chopping board 23x41 cm 8631 300</p>	 <p>L5 Glass chopping board 29x54 cm 8633 300</p>	 <p>M Sliding chopping board 30x54 8643 000</p>
 <p>N2 HDPE chopping board 27,2x42,5 cm 8657 001</p>	 <p>N3 HDPE Twin chopping board 31,7x42,5 cm 8644 101</p>	 <p>O2 White plastic bowl 27,2x41,4 cm 8153 100</p>	 <p>P2** Grating kit complete with ring support and food collection tray 8159 101</p>
 <p>S St. steel basket 40x40 8612 000 White basket 40x40 8612 100</p>	 <p>T1 St. steel dishes holder 25x42,5 cm 8100 201</p>	 <p>T2** St. steel dishes holder 21,4x37,9 cm 8100 303</p>	 <p>Z* St. steel colander 25x36 cm 8154 000</p>

*To use only with L3 chopping board **To use only with N3 chopping board

Triplo Invaso

FULLY FUNCTIONAL CENTER



suggested mixer taps

	Features	Version	Ref.	Technical Drawing
--	----------	---------	------	-------------------

Cabinet 90



52

AISI 304 brushed
dimensions: **860x520**
1 bowl: **710x400**
cut-out: 840x500
drain: **automatic**
SPACE 3½" PA



1490 060

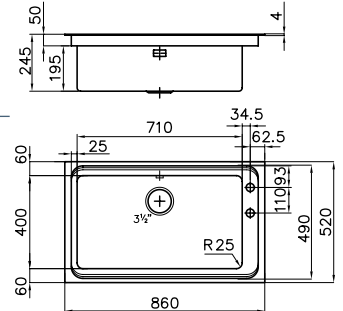

Accessories: **L4 M2 M3 N2 O2 S U2** (page 35)

Cabinet 90



52

AISI 304 brushed
dimensions: **860x520**
2b: **500x400+233x335**
cut-out: 840x500
drain:
automatic 3½" PR



1485 061 rh
1485 062 lh

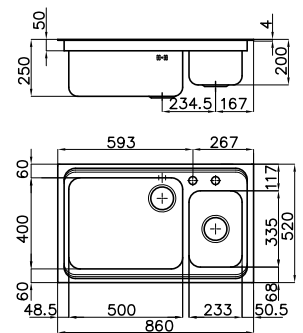

Picture shows lh version

Accessories:

L4 M2 M3 N2 O2 S U2 T4 Z (page 35)

Standard fittings: fixing brackets, gasket (not available for under-mount sinks), waste fitting, overflow and siphon. Packing: single carton box.

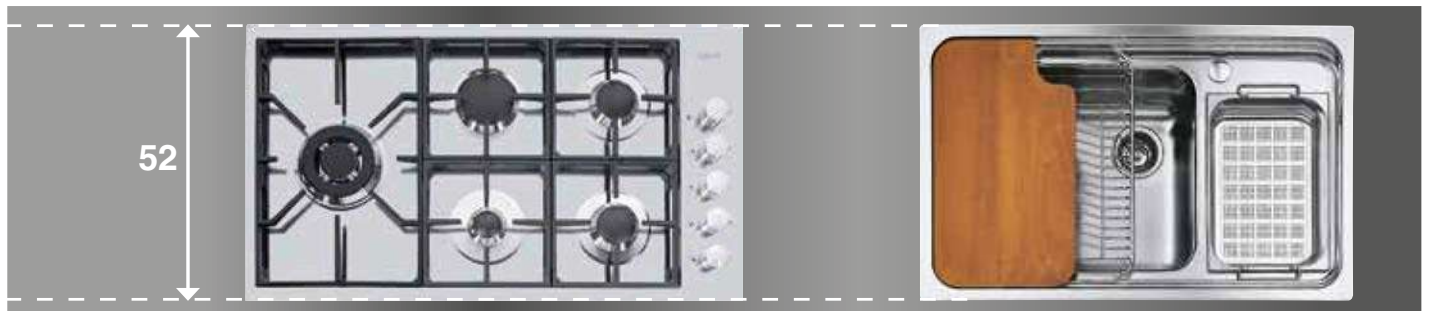

Perfect matching

Triplo Invaso sink is 52 cm deep, for a perfect matching with all S4000 gas cooker hobs.













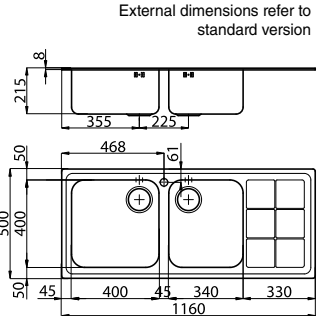



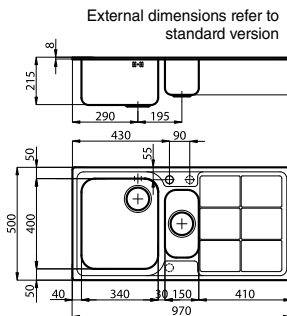

S3000

A CLASSIC OF ELEGANCE



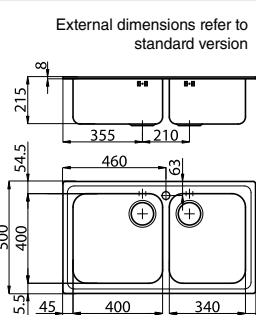







Flexo
(8456 000 - pag. 98)

suggested mixer taps

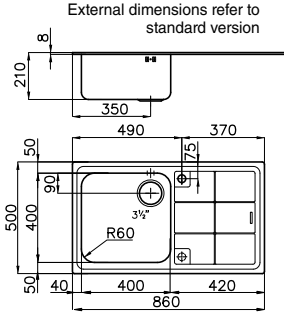
	Features	Version	Ref.	Technical Drawing
Cabinet 90  <i>Picture shows rh version</i>	AISI 304 brushed dimensions: 1160x500 2b: 400x400+340x400 cut-out: 1140x480 drain: 3½"	 STD	1312 061 rh 1312 062 lh	External dimensions refer to standard version 
		 SF	1318 061 rh 1318 062 lh	
		 FT  FTS	1315 061 rh 1315 062 lh	
Accessories: A G L1 L4 N2 N3 O2 P2 R S T2 T4 For Standard and Flat-edge version only: L5 M				
Cabinet 60(80) ^T (ref. page 10)  <i>Picture shows rh version</i>	AISI 304 brushed dimensions: 970x500 2b: 340x400+150x300 cut-out: 950x480 drain: 3½"	 STD	1363 061 rh 1363 062 lh	External dimensions refer to standard version 
		 SF	1365 061 rh 1365 062 lh	
		 FT  FTS	1365 061 rh 1365 062 lh	
Accessories: A L1 L4 N2 N3 O2 P2 Q R T2 T4 Standard and Flat-edge version only: L5 M Automatic waste fitting: PR PQ PC (page 86)				Second and third tap hole available
Cabinet 90  Accessories: A G L1 L4 N2 N3 O2 P2 R S T2 T4 Standard and Flat-edge version only: L5 M	AISI 304 brushed dimensions: 860x500 2b: 400x400+340x400 cut-out: 840x480 drain: 3½"	 STD	1382 062 lh	External dimensions refer to standard version 
		 SF	1388 062 lh	
		 FT  FTS	1385 062 lh	

Standard fittings: fixing brackets, gasket (not available for under-mount sinks), waste fitting, overflow and siphon. Packing: single carton box.

S3000

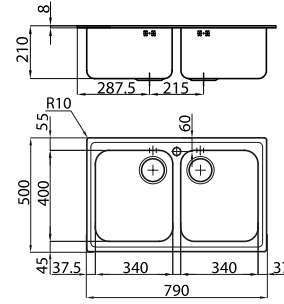





	Features	Version	Ref.	Technical Drawing
Cabinet 60  Picture shows lh version Accessories: G L1 L4 N2 N3 O2 P2 S T2 T4 Standard and Flat-edge version only: L5 M Automatic waste fitting: PR PQ PC (page 86)	AISI 304 brushed dimensions: 860x500 1 bowl: 400x400 cut-out: 840x480 drain: 3½"		1381 061 rh 1381 062 lh	External dimensions refer to standard version  Second tap hole available
	AISI 304 brushed dimensions: 873x513 1 bowl: 400x400 cut-out: 840x480 drain: 3½"		1387 061 rh 1387 062 lh	
	AISI 304 brushed dimensions: 873x513 1 bowl: 400x400 cut-out: flush-mount (FT): web site up-mount (FTS): 860x500 drain: 3½"	 	1384 061 rh 1384 062 lh	
Cabinet 80 	AISI 304 brushed dimensions: 790x500 2 bowls: 340x400 cut-out: 770x480 drain: 3½"		1372 060	
	Accessories: A L1 L4 L5 M N2 N3 O2 P2 R T2 T4	Standard fittings: fixing brackets, gasket (not available for under-mount sinks), waste fitting, overflow and siphon. Packing: single carton box.		

accessories

 A Chopping board 34x40 8647 000	 G Chopping board 40x40 8646 000	 L1 Twin chopping board 31,7x42,5 cm 8644 041	
 L4 Glass chopping board 23x41 cm 8631 300	 L5 Glass chopping board 29x54 cm 8633 300	 M Sliding chopping board 30x54 8643 000	 M2 Chopping board 28x48 8643 115
 M3 Sliding chopping board 28x48 8643 116	 N2 HDPE chopping board 27,2x42,5 cm 8657 001	 N3 HDPE Twin chopping board 31,7x42,5 cm 8644 101	 O2 White plastic bowl 27,2x41,4 cm 8153 100
 P2 ** Grating kit complete with ring support and food collection tray 8159 101	 Q White colander 17x32 cm 8151 100	 R St. steel basket 34x40 8611 000	 S St. steel basket 40x40 8612 000 White basket 40x40 8612 100
 T2 ** St. steel dishes holder 21,4x37,9 cm 8100 303	 T4 St. steel dishes holder 25x43 cm 8100 301	 U2 St. steel dishes holder 23x47 8100 115	 Z * St. steel colander 25x36 cm 8154 000

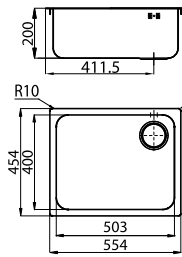
*To use only with L3 chopping board **To use only with N3 chopping board

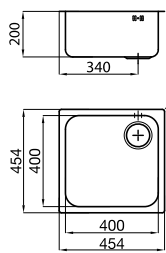
S3000

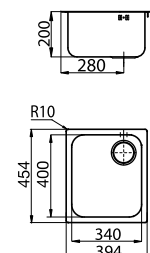
	Features	Version	Ref.	Technical Drawing
Cabinet 60	AISI 304 brushed dimensions: 554x454 1 bowl: 503x400 cut-out: flush-mount (FT): web site up-mount (FTS): 541x441 drain: 3½"	 	1116 061 rh 1116 062 lh	
Picture shows rh version Accessories: (page 35) L1 L4 N2 N3 O2 P2 S T2 Automatic waste fitting: PR PQ PC (page 86)				
Cabinet 45	AISI 304 brushed dimensions: 454x454 1 bowl: 400x400 cut-out: flush-mount (FT): web site up-mount (FTS): 441x441 drain: 3½"	 	1114 061 rh 1114 062 lh	
Picture shows rh version Accessories: (page 35) L1 L4 N2 N3 O2 P2 S T2 Automatic waste fitting: PR PQ PC (page 86)				
Cabinet 40	AISI 304 brushed dimensions: 394x454 1 bowl: 340x400 cut-out: flush-mount (FT): web site up-mount (FTS): 381x441 drain: 3½"	 	1117 061 rh 1117 062 lh	
Picture shows rh version Accessories: (page 35) L1 L4 N2 N3 O2 P2 R T2 Automatic waste fitting: PR PQ PC (page 86)				

Standard fittings: fixing brackets, gasket (not available for under-mount sinks), waste fitting, overflow and siphon. Packing: single carton box.
 For rh/lh version on mean bowl with drain on right/left side.



The artful combination of straight lines (draining board) and curved lines (the wide-radius bowls) creates an ideal match with either squared or curved-rod mixer taps.

Marine







HIGH RESISTANCE SUPER STAINLESS STEEL

AISI 316

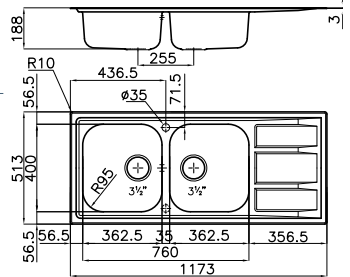

AISI 316
Stainless
Steel

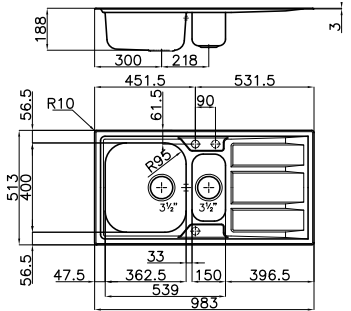

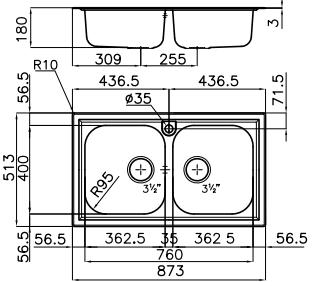
suggested mixer taps

	Features	Version	Ref.	Technical Drawing
<p>Cabinet 80/(90)^T (ref. page 10)</p>  <p><i>Picture shows lh version</i></p> <p>Accessories: L4 M N2 R T4 (page 38) Automatic waste fitting: PR PQ PC (page 86)</p>	<p>AISI 316 brushed dimensions: 1173x513 2 bowls: 362,5x400 cut-out: 1140x480 drain: 3/2" pre-installed gasket</p>		<p>1978 961 rh 1978 962 lh</p>	 <p>Second tap hole available</p>
<p>Cabinet 60 (80)^T (ref. page 10)</p>  <p><i>Picture shows lh version</i></p> <p>Accessories: L4 M N2 Q R T4 (page 38) Automatic waste fitting: PR PQ PC (page 86)</p>	<p>AISI 316 brushed dimensions: 983x513 2 b.: 362,5x400 + 150x300 cut-out: 950x480 drain: 3/2" pre-installed gasket</p>		<p>1977 961 rh 1977 962 lh</p>	 <p>Second and third tap hole available</p>
<p>Cabinet 80/(90)^T (ref. page 10)</p>  <p>Accessories: L4 M N2 R T4 (page 38)</p>	<p>AISI 316 brushed dimensions: 873x513 2 bowls: 362,5x400 cut-out: 840x480 drain: 3/2" pre-installed gasket</p>		<p>1976 960</p>	

Marine

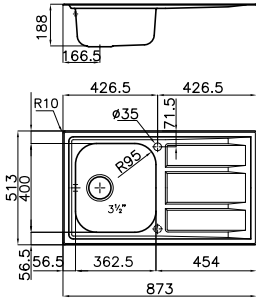
	Features	Version	Ref.	Technical Drawing
<p>Cabinet 45</p>  <p>Picture shows lh version</p> <p>Accessories: L4 M N2 R T4</p> <p>Automatic waste fitting: PR PQ PC (page 86)</p>	<p>AISI 316 brushed dimensions: 873x513 1 bowl: 362,5x400 cut-out: 840x480 drain: 3½" pre-installed gasket</p>		<p>1975 961 rh 1975 962 lh</p>	 <p>Second tap hole available</p>

Standard fittings: fixing brackets, gasket (not available for under-mount sinks), waste fitting, overflow and siphon. Packing: single carton box.

Super stainless steel

Foster Marine is the new range of sinks and cooker hobs specially designed for marine environments. Marine is made of AISI316 stainless steel, an alloy with high content of nickel and molybdenum ensuring outstanding stainless properties. **AISI316** stainless steel is a material of a higher class, that grants three times as much resistance to the effects of salt-rich atmospheres as the most commonly used AISI304. Marine cooker hob (see page 134).



Pre-installed gasket

Special features - Marine sinks are equipped with pre-installed gasket that allows a quick and convenient installation.

accessories



L4
 Glass chopping board
 23x41 cm
 8631 300



M
 Sliding chopping board
 30x54 cm
 8643 000



N2
 HDPE chopping board
 27,2x42,5 cm
 8657 001



Q
 White colander
 17x32 cm
 8151 100



R
 St. steel basket
 34x40 cm
 8611 000



T4
 St. steel dishes holder
 25x43 cm
 8100 301

KS

QUALITY AND PRACTICALITY

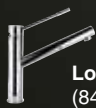











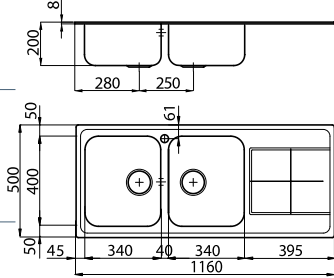

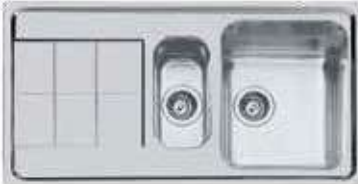
Lorenzo
(8486 000 - pag. 100)

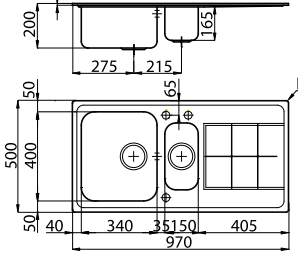

NYC
(8486 000 - pag. 100)

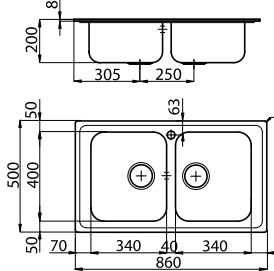



suggested mixer taps

	Features	Version	Ref.	Technical Drawing
Cabinet 80 	AISI 304 brushed dimensions: 1160x500 2 bowls: 340x400 cut-out: 1140x480 drain: 3½"		2112 061 rh 2112 062 lh	
		 	2112 461 rh 2112 462 lh	
<p>Picture shows rh version</p> <p>Accessories: (page 40) A L1 L4 L5 M N2 N3 O2 P2 R T2 T4</p>				
Cabinet 60/(80)^T (ref. page 10) 	AISI 304 brushed dimensions: 970x500 2b: 340x400+150x300 cut-out: 950x480 drain: 3½"		2163 061 rh 2163 062 lh	
		 	2163 461 rh 2163 462 lh	
<p>Picture shows rh version</p> <p>Accessories: (page 40) A L1 L4 L5 M N2 N3 O2 P2 Q R T2 T4</p> <p>Automatic waste fitting: PR PQ PC (page 86)</p>				
Cabinet 80/(90)^T (ref. page 10) 	AISI 304 brushed dimensions: 860x500 2 bowls: 340x400 cut-out: 840x480 drain: 3½"		2182 060	
		 	2182 460	
<p>Accessories: (page 40) A L1 L4 L5 M N2 N3 O2 P2 R T2 T4</p>				

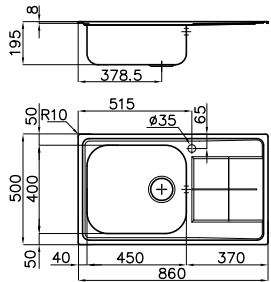

Second and third tap hole available

Standard fittings: fixing brackets, gasket (not available for under-mount sinks), waste fitting, overflow and siphon. Packing: single carton box.

KS

	Features	Version	Ref.	Technical Drawing
Cabinet 60  Picture shows rh version	AISI 304 brushed dimensions: 860x500 1 bowl: 450x400 cut-out: 840x480 drain: 3½"	 STD	2180 061 rh 2180 062 lh	
		AISI 304 microfoster dimensions: 860x500 1 bowl: 450x400 cut-out: 840x480 drain: 3½"	 STD  microfoster	

Accessories:
E L1 L4 L5 M N2 N3 O2 P2 S T2 T4

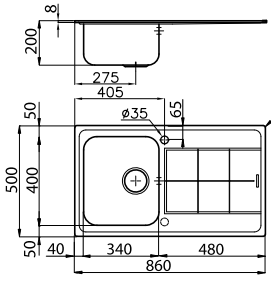
Cabinet 45  Picture shows rh version Accessories: A L1 L4 L5 M N2 N3 O2 P2 R T2 T4 Automatic waste fitting: PR PQ PC (page 86)	AISI 304 brushed dimensions: 860x500 1 bowl: 340x400 cut-out: 840x480 drain: 3½"	 STD	2181 061 rh 2181 062 lh	 Second tap hole available
--	--	---	----------------------------	--

Standard fittings: fixing brackets, gasket (not available for under-mount sinks), waste fitting, overflow and siphon. Packing: single carton box.

accessories

 A Chopping board 34x40 8647 000	 E Chopping board 45x40 8655 000	 L1 Twin chopping board 31,7x42,5 cm 8644 041	
 L4 Glass chopping board 23x41 cm 8631 300	 L5 Glass chopping board 29x54 cm 8633 300	 M Sliding chopping board 30x54 8643 000	 N2 HDPE chopping board 27,2x42,5 cm 8657 001
 N3 HDPE Twin chopping board 31,7x42,5 cm 8644 101	 O2 White plastic bowl 27,2x41,4 cm 8153 100	 P2 ** Grating kit complete with ring support and food collection tray 8159 101	 Q White colander 17x32 cm 8151 100
 R St. steel basket 34x40 cm 8611 000	 S St. steel basket 40x40 8612 000 White basket 40x40 8612 100	 T2 ** St. steel dishes holder 21,4x37,9 cm 8100 303	 T4 St. steel dishes holder 25x43 cm 8100 301

**To use only with N3 chopping board

F300







PRACTICALITY WITH STYLE



Beta
(8490 000 - pag. 104)

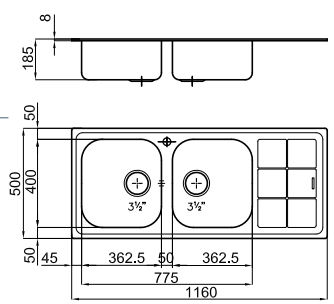

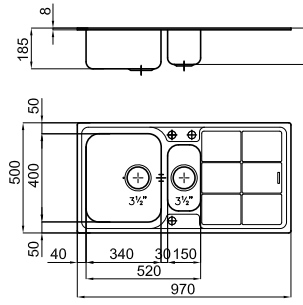
Luisa
(8482 000 - pag. 101)

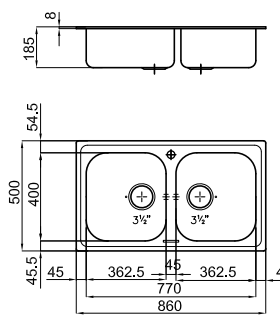
suggested mixer taps

	Features	Version	Ref.	Technical Drawing
<p>Cabinet 90</p>  <p>Picture shows lh version</p> <p>Accessories: L4 M N2 O2 R T4</p>	<p>AISI 304 brushed dimensions: 1160x500 2 bowls: 362,5x400 cut-out: 1140x480 drain: 3½"</p>		<p>1354 061 rh 1354 062 lh</p>	
<p>Cabinet 60</p>  <p>Picture shows lh version</p> <p>Accessories: A M N2 O2 Q R T4 Automatic waste fitting: PR PQ PC (page 86)</p>	<p>AISI 304 brushed dimensions: 970x500 2 b.: 340x400 + 150x300 cut-out: 950x480 drain: 3½"</p>		<p>1353 061 rh 1353 062 lh</p>	 <p>Second and third tap hole available</p>
<p>Cabinet 90</p>  <p>Accessories: L4 M N2 O2 R T4</p>	<p>AISI 304 brushed dimensions: 860x500 2 bowls: 362,5x400 cut-out: 840x480 drain: 3½"</p>		<p>1352 060</p>	

Standard fittings: fixing brackets, gasket (not available for under-mount sinks), waste fitting, overflow and siphon. Packing: single carton box.

F300

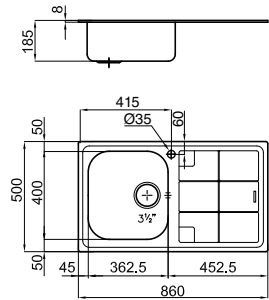
	Features	Version	Ref.		Technical Drawing
<p>Cabinet 45</p>  <p>Picture shows lh version</p>	<p>AISI 304 brushed dimensions: 860x500 1 bowl: 362,5x400 cut-out: 840x480 drain: 3½"</p>		<p>1351 061 rh 1351 062 lh</p>		

Accessories: **L4** **M** **N2** **O2** **R** **T4**

Standard fittings: fixing brackets, gasket (not available for under-mount sinks), waste fitting, overflow and siphon. Packing: single carton box.



Matchings

Elegant and functional matching. F300 sink with refined Eletttra hob.

accessories



A
Chopping board
34x40
8647 000



L4
Glass chopping board
23x41 cm
8631 300



M
Sliding chopping board 30x54
8643 000

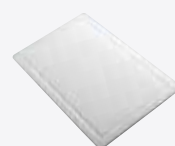

N2
HDPE chopping board
27,2x42,5 cm
8657 001



O2
White plastic bowl
27,2x41,4 cm
8153 100



Q
White colander
17x32 cm
8151 100

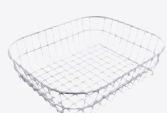

R
St. steel basket
34x40 cm
8611 000



T4
St. steel dishes holder
25x43 cm
8100 301

Elettra

THE ELEGANCE OF SIMPLICITY









Luisa
(8482 000 - pag. 101)



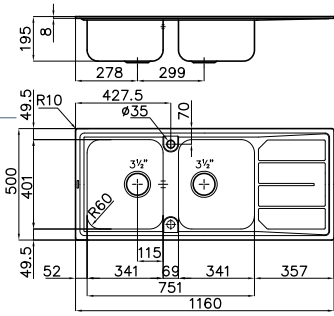

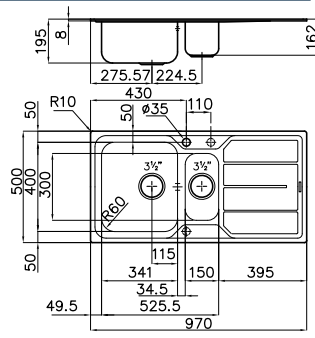
Elettra
(8476 000 - pag. 104)

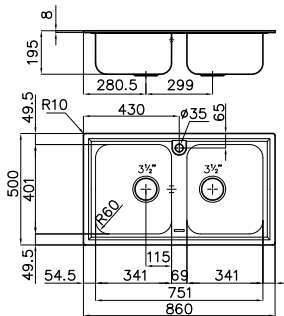
suggested mixer taps

	Features	Version	Ref.	Technical Drawing
<p>Cabinet 80/(90)^T (ref. page 10)</p>  <p>Picture shows lh version</p> <p>Accessories: A L4 M N2 O2 R T4 Automatic waste fitting: PR PQ PC (page 86)</p>	<p>AISI 304 brushed dimensions: 1160x500 2 bowls: 341x401 cut-out: 1140x480 drain: 3½"</p>		<p>5812 061 rh 5812 062 lh</p>	 <p>Second tap hole available</p>
<p>Cabinet 60</p>  <p>Picture shows lh version</p> <p>Accessories: A L4 M N2 O2 Q R T4 Automatic waste fitting: PR PQ PC (page 86)</p>	<p>AISI 304 brushed dimensions: 970x500 2b: 341x400 + 150x300 cut-out: 950x480 drain: 3½"</p>		<p>5197 061 rh 5197 062 lh</p>	 <p>Second and third tap hole available</p>
<p>Cabinet 80/(90)^T (ref. page 10)</p>  <p>Accessories: A L4 M N2 O2 R T4</p>	<p>AISI 304 brushed dimensions: 860x500 2 bowls: 341x401 cut-out: 840x480 drain: 3½"</p>		<p>5886 060</p>	

Standard fittings: fixing brackets, gasket (not available for under-mount sinks), waste fitting, overflow and siphon. Packing: single carton box.

Elettra

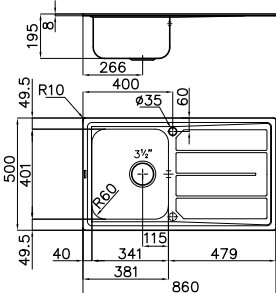
	Features	Version	Ref.	Technical Drawing
<p>Cabinet 45</p>  <p>Picture shows lh version</p> <p>Accessories: A L4 M N2 O2 R T4</p> <p>Automatic waste fitting: PR PQ PC (page 86)</p>	<p>AISI 304 brushed dimensions: 860x500 1 bowl: 341x401 cut-out: 840x480 drain: 3½"</p>		<p>5186 061 rh 5186 062 lh</p>	 <p>Only taps with max ø 45 mm base footprint are installable Second tap hole available</p>

Standard fittings: fixing brackets, gasket (not available for under-mount sinks), waste fitting, overflow and siphon. Packing: single carton box.



Large and deep bowls in a really practical and functional design.

accessories

 <p>A Chopping board 34x40 8647 000</p>	 <p>L4 Glass chopping board 23x41 cm 8631 300</p>	 <p>M Sliding chopping board 30x54 8643 000</p>	 <p>N2 HDPE chopping board 27,2x42,5 cm 8657 001</p>
 <p>O2 White plastic bowl 27,2x41,4 cm 8153 100</p>	 <p>Q White colander 17x32 cm 8151 100</p>	 <p>R St. steel basket 34x40 cm 8611 000</p>	 <p>T4 St. steel dishes holder 25x43 cm 8100 301</p>

FM

THE STURDINESS OF THE SINK WITHOUT WELDING



suggested mixer taps

	Features	Version	Ref.	Technical Drawing
--	----------	---------	------	-------------------

Cabinet 80/(90)^T (ref. page 10)



Picture shows lh version

AISI 304 brushed
 dimensions: **1160x500**
 2 bowls: **362,5x400**
 cut-out: 1140x480
 drain: 3½"



1972 061 rh
 1972 062 lh

AISI 304 **microfoster**
 dimensions: **1160x500**
 2 bowls: **362,5x400**
 cut-out: 1140x480
 drain: 3½"



1972 461 rh
 1972 462 lh

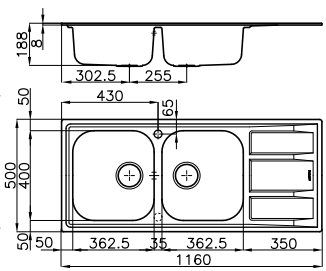

Second tap hole available

Accessories: **L4 M N2 R T4**
 Automatic waste fitting: **PR PQ PC** (page 86)

Cabinet 60/(80)^T (ref. page 10)



Picture shows lh version

AISI 304 brushed
 dimensions: **970x500**
 2b: **362,5x400+150x300**
 cut-out: 950x480
 drain: 3½"



1973 061 rh
 1973 062 lh

AISI 304 **microfoster**
 dimensions: **970x500**
 2b: **362,5x400+150x300**
 cut-out: 950x480
 drain: 3½"



1973 461 rh
 1973 462 lh

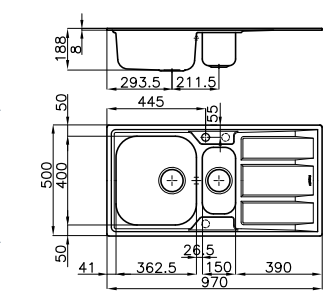

Second and third tap hole available

Accessories: **M N2 Q R T4**
 Automatic waste fitting: **PR PQ PC** (page 86)

Cabinet 80/(90)^T (ref. page 10)



AISI 304 brushed
 dimensions: **860x500**
 2 bowls: **362,5x400**
 cut-out: 840x480
 drain: 3½"



1974 060

AISI 304 **microfoster**
 dimensions: **860x500**
 2 bowls: **362,5x400**
 cut-out: 840x480
 drain: 3½"



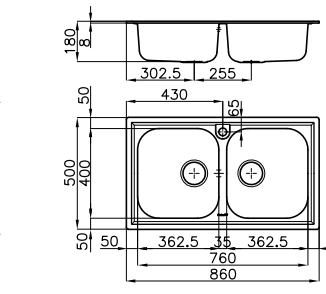

1974 460

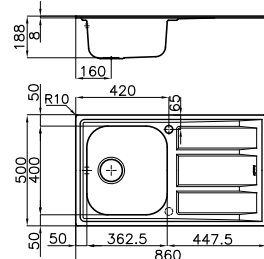

Accessories: **L4 M N2 R T4**
 Standard fittings: fixing brackets, gasket (not available for under-mount sinks), waste fitting, overflow and siphon. Packing: single carton box.

FM

	Features	Version	Ref.	Technical Drawing
Cabinet 45	AISI 304 brushed dimensions: 860x500 1 bowl: 362,5x400 cut-out: 840x480 drain: 3½"		1971 061 rh 1971 062 lh	
	AISI 304 microfooster dimensions: 860x500 1 bowl: 362,5x400 cut-out: 840x480 drain: 3½"	 	1971 461 rh 1971 462 lh	

Picture shows lh version

Accessories: **L4 M N2 R T4**
Automatic waste fitting: **PR PQ PC** (page 86)

Second tap hole available

Standard fittings: fixing brackets, gasket (not available for under-mount sinks), waste fitting, overflow and siphon. Packing: single carton box.



Deep bowls

19 cm deep and capacious bowls, inserted in a generous safe-drop profile, for this sturdy and practical sink.

accessories

 A Chopping board 34x40 8647 000	 E Chopping board 45x40 8655 000	 L1 Twin chopping board 31,7x42,5 cm 8644 041	
 L4 Glass chopping board 23x41 cm 8631 300	 L5 Glass chopping board 29x54 cm 8633 300	 M Sliding chopping board 30x54 8643 000	 N2 HDPE chopping board 27,2x42,5 cm 8657 001
 N3 HDPE Twin chopping board 31,7x42,5 cm 8644 101	 O2 White plastic bowl 27,2x41,4 cm 8153 100	 P2 ** Grating kit complete with ring support and food collection tray 8159 101	 Q White colander 17x32 cm 8151 100
 R St. steel basket 34x40 cm 8611 000	 S St. steel basket 40x40 8612 000 White basket 40x40 8612 100	 T2 ** St. steel dishes holder 21,4x37,9 cm 8100 303	 T4 St. steel dishes holder 25x43 cm 8100 301













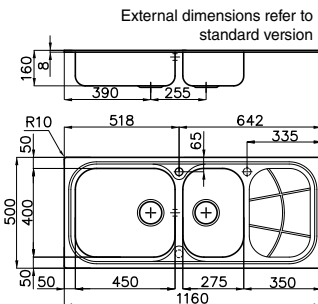

**To use only with N3 chopping board

Big Bowl

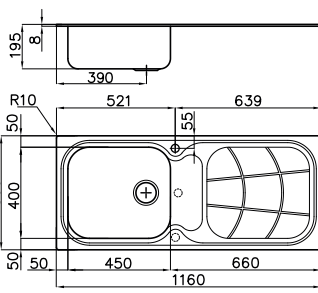
ALL THE CONVENIENCE OF A LARGE CAPACIOUS BOWL



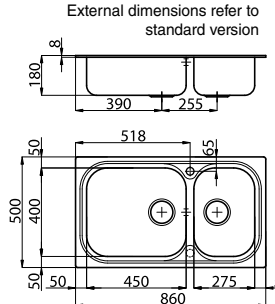

suggested mixer taps

	Features	Version	Ref.	Technical Drawing
Cabinet 90  <p>Picture shows rh version</p>	AISI 304 brushed dimensions: 1160x500 2b: 450x400+275x400 cut-out: 1140x480 drain: 3½"	 STD	1512 201 rh 1512 202 lh	External dimensions refer to standard version 
		 STD  microfoster	1512 401 rh 1512 402 lh	
	AISI 304 brushed dimensions: 1173x513 2b: 450x400+275x400 cut-out: 1140x480 drain: 3½"	 SF	1076 061 rh 1076 062 lh	
Accessories: E L4 M N2 S T3 T4 (page 49) Automatic waste fitting: PR PQ PC (page 86)				Second and third tap hole available
Cabinet 60  <p>Picture shows rh version</p>	AISI 304 brushed dimensions: 1160x500 1 bowl: 450x400 cut-out: 1140x480 drain: 3½" the overflow is outside the bowl	 STD	1513 201 rh 1513 202 lh	
		 STD	1513 201 rh 1513 202 lh	
Accessories: E L4 M N2 S T4 (page 49) Automatic waste fitting: PR PQ PC (page 86)				Second tap hole available
Cabinet 90  <p>Picture shows lh version</p>	AISI 304 brushed dimensions: 860x500 2b: 450x400+275x400 cut-out: 840x480 drain: 3½"	 STD	1562 001 rh 1562 002 lh	External dimensions refer to standard version 
		 STD	1562 001 rh 1562 002 lh	
	AISI 304 brushed dimensions: 873x513 2b: 450x400+275x400 cut-out: 840x480 drain: 3½"	 SF	1072 061 rh 1072 062 lh	
Accessories: E L4 M N2 S T3 T4 (page 49) Automatic waste fitting: PR PQ PC (page 86)				Second tap hole available

Standard fittings: fixing brackets, gasket (not available for under-mount sinks), waste fitting, overflow and siphon. Packing: single carton box.

Big Bowl







	Features	Version	Ref.	Technical Drawing
Cabinet 60  <i>Picture shows rh version</i> Accessories: E L4 M N2 S T4 Automatic waste fitting: PR PQ PC (page 86)	AISI 304 brushed dimensions: 860x500 1 bowl: 450x400 cut-out: 840x480 drain: 3½"		1561 201 rh 1561 202 lh	External dimensions refer to standard version  Second tap hole available
	AISI 304 microfoster dimensions: 860x500 1 bowl: 450x400 cut-out: 840x480 drain: 3½"	 	1561 401 rh 1561 402 lh	
	AISI 304 brushed dimensions: 873x513 1 bowl: 450x400 cut-out: 840x480 drain: 3½"		1071 061 rh 1071 062 lh	
Cabinet 60  <i>Picture shows lh version</i> Accessories: E L4 N2 S T4 Automatic waste fitting: PR PQ PC (page 86)	AISI 304 brushed dimensions: 590x500 1 bowl: 450x400 cut-out: 570x480 drain: 3½"		1511 001 rh 1511 002 lh	 Second tap hole available

Standard fittings: fixing brackets, gasket (not available for under-mount sinks), waste fitting, overflow and siphon. Packing: single carton box.

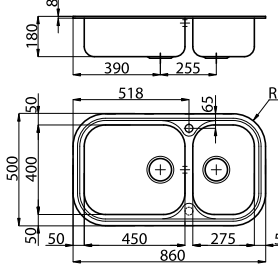

The main feature of the Big Bowl sinks is the large 45x40 cm bowl. A practical and versatile solution.

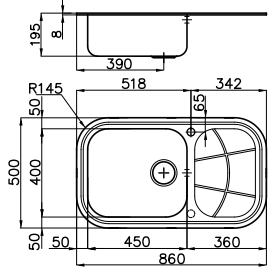
Big Bowl Soft

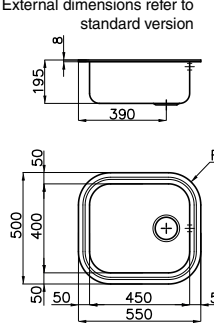
	Features	Version	Ref.	Technical Drawing
<p>Cabinet 90</p>  <p>Picture shows rh version</p> <p>Accessories: E L4 N2 S T3 T4 Standard version only: M Automatic waste fitting: PR PQ PC (page 86)</p>	<p>AISI 304 brushed dimensions: 860x500 2b: 450x400+275x400 cut-out: 840x480 R 135 drain: 3½"</p>		<p>1662 001 rh 1662 002 lh</p>	 <p>Second tap hole available</p>
<p>Cabinet 60</p>  <p>Picture shows rh version</p> <p>Accessories: E L4 N2 S T4 Standard version only: M Automatic waste fitting: PR PQ PC (page 86)</p>	<p>AISI 304 brushed dimensions: 860x500 1 bowl: 450x400 cut-out: 840x480 R 135 drain: 3½"</p>		<p>1661 201 rh 1661 202 lh</p>	 <p>Second tap hole available</p>
<p>Cabinet 60</p>  <p>Accessories: E L4 N2 S T4 Automatic waste fitting: PR PQ PC (page 86)</p>	<p>AISI 304 brushed dimensions: 550x500 1 bowl: 450x400 cut-out: 530x480 R 135 drain: 3½"</p>		<p>1611 060</p>	<p>External dimensions refer to standard version</p> 

Standard fittings: fixing brackets, gasket (not available for under-mount sinks), waste fitting, overflow and siphon. Packing: single carton box.

accessories



E
Chopping board 45x40
8655 000



L4
Glass chopping board
23x41 cm
8631 300



M
Sliding chopping board 30x54
8643 000



N2
HDPE chopping board
27,2x42,5 cm
8657 001



Q
White colander
17x32 cm
8151 100



S
St. steel basket 40x40
8612 000
White basket 40x40
8612 100



T3
St. steel dishes holder 28x40 cm
8100 280









T4
St. steel dishes holder 25x43 cm
8100 301

Moon

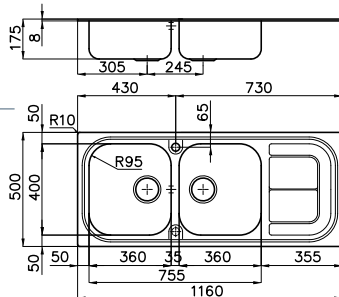
PRACTICALITY WITH A TOUCH OF CLASS

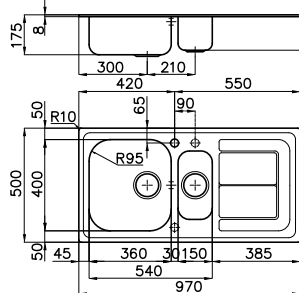

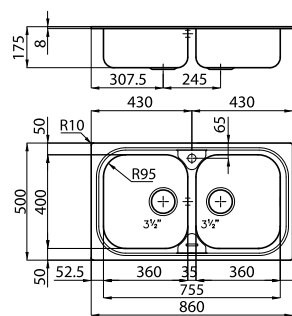
	Features	Version	Ref.	Technical Drawing
<p>Cabinet 80/(90)^T (ref. page 10)</p>  <p><i>Picture shows lh version</i></p> <p>Accessories: L4 M N2 R T4</p>	<p>AISI 304 brushed dimensions: 1160x500 2 bowls: 360x400 cut-out: 1140x480 drain: 3½"</p>		<p>1284 001 rh 1284 002 lh</p>	 <p>Second tap hole available</p>
<p>Cabinet 60/(80)^T (ref. page 10)</p>  <p><i>Picture shows lh version</i></p> <p>Accessories: M N2 Q R T4</p>	<p>AISI 304 brushed dimensions: 970x500 2 b: 360x400+150x300 cut-out: 950x480 drain: 3½"</p>		<p>1283 001 rh 1283 002 lh</p>	 <p>Second tap hole available</p>
<p>Cabinet 80/(90)^T (ref. page 10)</p>  <p>Accessories: L4 M N2 R T4</p>	<p>AISI 304 brushed dimensions: 860x500 2 bowls: 360x400 cut-out: 840x480 drain: 3½"</p>		<p>1962 060</p>	

Standard fittings: fixing brackets, gasket (not available for under-mount sinks), waste fitting, overflow and siphon. Packing: single carton box.

Moon

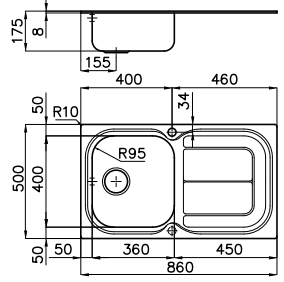
	Features	Version	Ref.		Technical Drawing
Cabinet 45	AISI 304 brushed dimensions: 860x500 1 bowl: 360x400 cut-out: 840x480 drain: 3½"	 STD	1281 001 rh 1281 002 lh		



Picture shows lh version

Accessories: **L4** **M** **N2** **R** **T4**

Standard fittings: fixing brackets, gasket (not available for under-mount sinks), waste fitting, overflow and siphon. Packing: single carton box.

Second tap hole available

Strength and design

Moon is the last-born in the Foster one-piece sinks ranges. It offers all the sturdiness typical of the sinks without welding, an elegant design, the practicality of deep and spacious bowls, all of which at an exceptional pricequality ratio.



accessories



L4
Glass chopping board
23x41 cm
8631 300



M
Sliding chopping board 30x54
8643 000

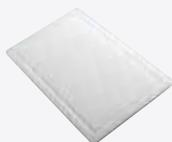

N2
HDPE chopping board
27,2x42,5 cm
8657 001



Q
White colander
17x32 cm
8151 100

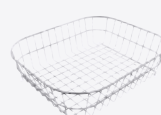

R
St. steel basket
34x40 cm
8611 000



T4
St. steel dishes holder 25x43 cm
8100 301

Uragano

A SINGLE BOWL FOR GREAT PERFORMANCE



suggested mixer taps

	Features	Version	Ref.	Technical Drawing
--	----------	---------	------	-------------------

Cabinet 100



AISI 304 brushed dimensions: **970x500**
1 bowl: **910x440**
cut-out: 950x480
drain: 3½"



1555 600

1555 609
accessory kit included

AISI 304 brushed dimensions: **983x513**
1 bowl: **910x440**
cut-out: 950x480
drain: 3½"



1054 600

1054 609
accessory kit included

External dimensions refer to standard version

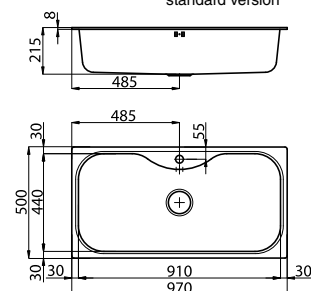

Accessories:

I L2 O Q T U V Z (page 54)

Cabinet 100



AISI 304 brushed dimensions: **983x513**
1 bowl: **910x440**
cut-out: flush-mount (FT):
web site
up-mount (FTS):
970x500 R 145
drain: 3½"



1055 600



1055 609
accessory kit included

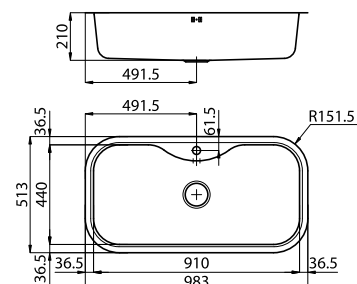

Accessories:

I L2 O Q T U V Z (page 54)

Standard fittings: fixing brackets, gasket (not available for under-mount sinks), waste fitting, overflow and siphon. Packing: single carton box.

Uragano accessory kit



I Chopping board
37x46 cm
8659 112



V St. steel bowl holder
37x45 cm
8100 112



O White plastic bowl
36x30 cm
8152 100



Q White colander
17x32 cm
8151 100

Discover the great functionality of the big Uragano bowl. Now available also in the accessorized version, including the practical kit described aside.

The full range of matching accessories is presented in the following pages.



Tornado

ALL YOU NEED IN 80 CM

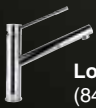









Lorenzo
(8466 000 - pag. 100)

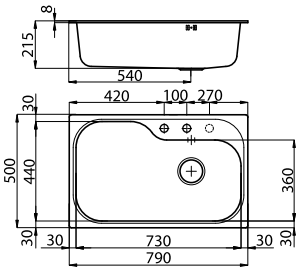

Gamma
(8483 001 - pag. 100)

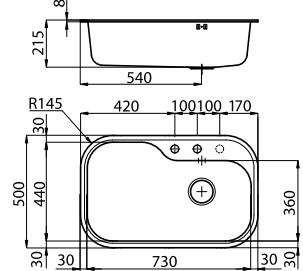
suggested mixer taps

	Features	Version	Ref.	Technical Drawing
<p>Cabinet 80</p> 	<p>AISI 304 brushed dimensions: 790x500 1 bowl: 730x440 cut-out: 770x480 drain: automatic 3½"</p>		1579 660	<p>External dimensions refer to standard version</p> 
	<p>AISI 304 brushed dimensions: 803x513 1 bowl: 730x440 cut-out: 770x480 drain: automatic 3½"</p>		1078 660	
<p>Accessories: H I L O Q T U Z (page 54)</p>				Third tap hole available
<p>Cabinet 80</p> 	<p>AISI 304 brushed dimensions: 790x500 1 bowl: 730x440 cut-out: 770x480 R 135 drain: automatic 3½"</p>		1679 660	<p>External dimensions refer to standard version</p> 
	<p>AISI 304 brushed dimensions: 803x513 1 bowl: 730x440 cut-out: flush-mount (FT): web site up-mount (FTS): 790x500 R 145 drain: automatic 3½"</p>	 	1079 660	
<p>Accessories: H I L O Q T U Z (page 54)</p>				Third tap hole available

Standard fittings: fixing brackets, gasket (not available for under-mount sinks), waste fitting, overflow and siphon. Packing: single carton box.

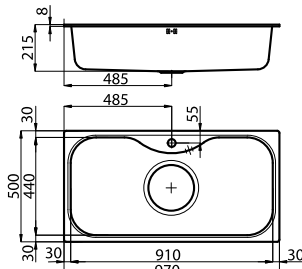

7" Uragano and Tornado

	Features	Version	Ref.	Technical Drawing
Cabinet 100	AISI 304 brushed dimensions: 970x500 1 bowl: 910x440 cut-out: 950x480 drain: 7"	 STD	1555 070	

Accessories: **I L2 O Q T U V Z**

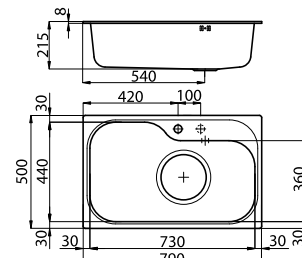
Cabinet 80	AISI 304 brushed dimensions: 790x500 1 bowl: 730x440 cut-out: 770x480 drain: 7"	 STD	1579 670	
-------------------	---	---	----------	---

Accessories: **H I L2 O Q T U Z**

Standard fittings: fixing brackets, gasket (not available for under-mount sinks), 7" waste fitting/siphon, overflow. Packing: single carton box.

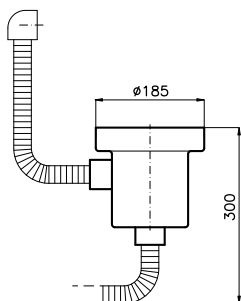









Extralarge waste fittings

The large bowls of Uragano and Tornado are particularly suited to the drain with 7" hole: an original solution, very practical thanks to the large stainless steel collecting basket.



accessories

 H Chopping board 37x30 8659 111	 I Chopping board 37x46 cm 8659 112	 L2 Twin chopping board 37x46 cm 8644 003	 O** White plastic bowl 36x30 cm 8152 100
 Q White colander 17x32 cm 8151 100	 T St. steel dishes holder 25x35 cm 8100 154	 U St. steel dishes holder 25x45 cm 8100 111	 V St. steel bowl holder 37x45 cm 8100 112
			 Z* St. steel colander 25x36 cm 8154 000

*to use only with L2 chopping board **to use only with V bowl holder

Angolare

SOLUTIONS TO ENHANCE THE CORNERS



S1000 - Z66
(8448 500 - pag. 104)

Camillo
(8467 000 - pag. 97)

suggested mixer taps

	Features	Version	Ref.	Technical Drawing
--	----------	---------	------	-------------------

Cabinet 90x90



AISI 304 brushed
dimensions: **830x830**
2 bowls: **340x400**
cut-out: see web site
drain: 3½"

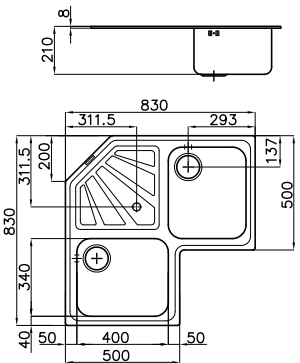

Accessories: **A N2 O2 R T4 W**

Cabinet 90 (linear)



AISI 304 brushed
dimensions: **830x830**
2b: **340x400+233x335**
cut-out: see web site
drain:
3½" + 1¼" on drainer

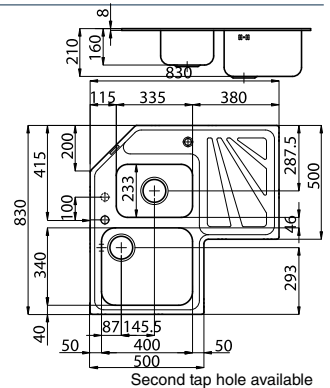

Accessories: **A N2 O2 R T T4 Z**

Automatic waste fitting: **PR PQ PC** (page 86)

Standard fittings: fixing brackets, gasket (not available for under-mount sinks), waste fitting, overflow and siphon. Packing: single carton box.

accessories

 A Chopping board 34x40 cm 8647 000	 N2 HDPE chopping board 27,2x42,5 cm 8657 001	 O2 White plastic bowl 27,2x41,4 cm 8153 100
 R St. steel basket 34x40 cm 8611 000	 T St. steel dishes holder 25x35 cm 8100 154	 T4 St. steel dishes holder 25x43 cm 8100 301
 V St. steel bowl holder 37x45 cm 8100 112	 Z * St. steel colander 25x36 cm 8154 000	

*to use only with L2 chopping board

Diamant

AN ORIGINAL AND VERSATILE SOLUTION



F2000 - Basso
(8459 000 - pag. 104)



Play
(8487 000 - pag. 96)

suggested mixer taps

	Features	Version	Ref.	Technical Drawing
--	----------	---------	------	-------------------

Cabinet 60



AISI 304 brushed
dimensions: **988x508**
2b: **340x400+150x300**
cut-out: see web site
drain: **automatic 3 1/2"**



3312 062

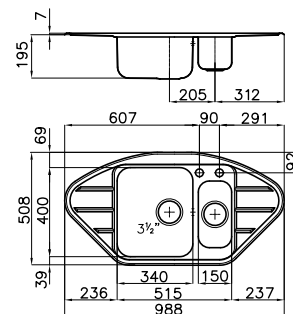

Accessories: **A L4 N2 O2 Q R T4**

Cabinet 80



AISI 304 brushed
dimensions: **988x508**
1 bowl: **504x400**
cut-out: see web site
drain: **3 1/2"**



3321 060

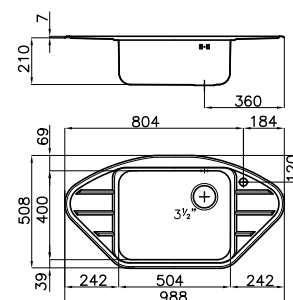

Accessories: **G L4 N2 O2 S**

Standard fittings: fixing brackets, gasket (not available for under-mount sinks), waste fitting, overflow and siphon. Packing: single carton box.

accessories

R p. 57



A
Chopping board
34x40 cm
8647 000



G
Chopping board
40x40 cm
8646 000

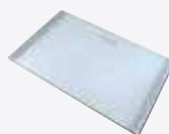

L4
Glass chopping board
23x41 cm
8631 300

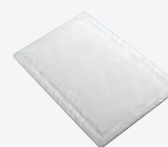

N2
Chopping board
HDPE
27,2x42,5 cm
8657 001



O2
White plastic bowl
41,4x27,2 cm
8153 100



Q
White colander
17x32 cm
8151 100



S
St. steel basket 40x40
8612 000

White basket 40x40
8612 100



T4
St. steel dishes holder
25x43 cm
8100 301

Circolari

SIMPLICITY GOES AROUND









S1000 - Z65
(8449 500 - pag. 105)

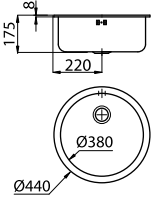

F2000 alto
(8558 000 - pag. 103)

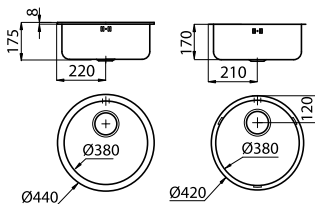
suggested mixer taps

	Features	Version	Ref.	Technical Drawing
Cabinet 45 	AISI 304 brushed dimensions: Ø 440 1 bowl: Ø 380 cut-out: Ø 420 drain: 2"		1010 000	
Cabinet 45 	AISI 304 brushed dimensions: Ø 440 1 bowl: Ø 380 cut-out: Ø 420 drain: 3½"		1010 060	
	AISI 304 brushed dimensions: Ø 420 1 bowl: Ø 380 cut-out: flush-mount (FT): web site up-mount (FTS): Ø 407 drain: 3½"	 	1110 060	

Standard fittings: fixing brackets, gasket (not available for under-mount sinks), waste fitting, overflow and siphon. Packing: single carton box.

S1000 accessories



M
Sliding chopping
board 30x54
8643 000



N2
HDPE chopping
board
27,2x42,5 cm
8657 001

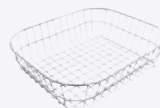

R
St. steel basket
34x40 cm
8611 000



T4
St. steel dishes
holder 25x43 cm
8100 301

S1000

QUALITY AND THICKNESS OF FOSTER STEEL

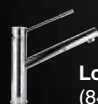











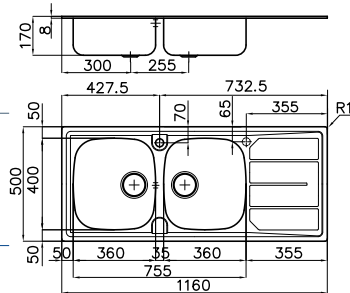

Lorenzo
(8466 000 - pag. 100)

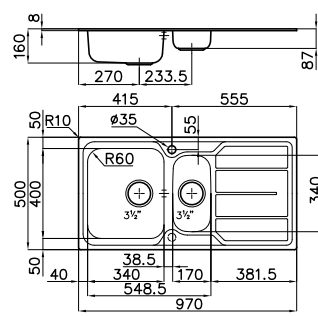

S1000 - RO
(8443 002 - pag. 105)

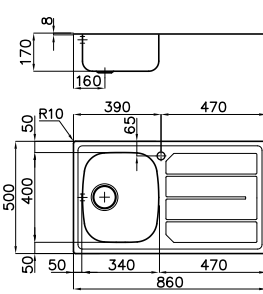
suggested mixer taps

	Features	Version	Ref.	Technical Drawing
Cabinet 80(90)^T (ref. page 10) 	AISI 304 brushed dimensions: 1160x500 2 bowls: 360x400 cut-out: 1140x480 drain: 3½"		1812 161 rh 1812 162 lh	 <p>Second tap hole available</p>
	AISI 304 microfoster dimensions: 1160x500 2 bowls: 360x400 cut-out: 1140x480 drain: 3½"	 	1812 461 rh 1812 462 lh	
Cabinet 60(80)^T (ref. page 10) 	AISI 304 brushed dimensions: 970x500 2b: 340x400+170x300 cut-out: 950x480 drain: 3½"		1197 161 rh 1197 162 lh	 <p>Second tap hole available</p>
	AISI 304 microfoster dimensions: 970x500 2b: 340x400+170x300 cut-out: 950x480 drain: 3½"	 	1197 461 rh 1197 462 lh	
Cabinet 45 	AISI 304 brushed dimensions: 860x500 1 bowl: 340x400 cut-out: 840x480 drain: 3½"		1186 161 rh 1186 162 lh	
	AISI 304 microfoster dimensions: 860x500 1 bowl: 340x400 cut-out: 840x480 drain: 3½"	 	1186 461 rh 1186 462 lh	

Picture shows lh version

Accessories: **M N2 R T4** (page 57)
 Automatic waste fitting: **PR PQ PC** (page 86)

Picture shows lh version













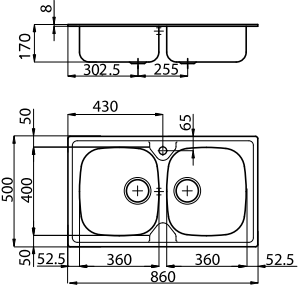

Accessories: **M N2 R T4** (page 57)
 Automatic waste fitting: **PR PQ PC** (page 86)

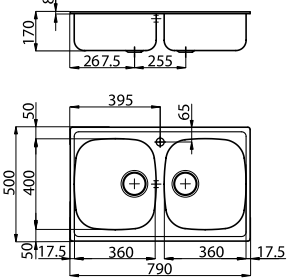
Picture shows lh version

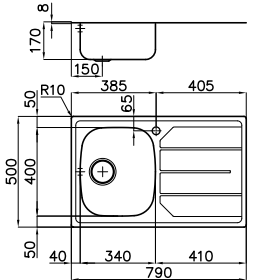
Accessories: **M N2 R T4** (page 57)

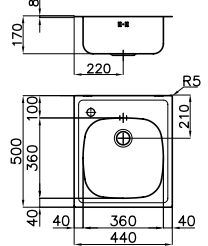
Standard fittings: fixing brackets, gasket (not available for under-mount sinks), waste fitting, overflow and siphon. Packing: single carton box.

S1000

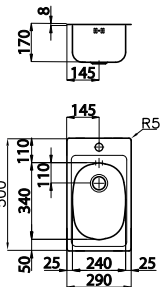
	Features	Version	Ref.	Technical Drawing
Cabinet 80(90) [†] (ref. page 10) 	AISI 304 brushed dimensions: 860x500 2 bowls: 360x400 cut-out: 840x480 drain: 3½"		1886 160	
		 	1886 460	
Accessories: M N2 R T4 (page 57)				
Cabinet 80 	AISI 304 brushed dimensions: 790x500 2 bowls: 360x400 cut-out: 770x480 drain: 3½"		1279 060	
Accessories: M N2 R T4 (page 57)				
Cabinet 45 	AISI 304 brushed dimensions: 790x500 1 bowl: 340x400 cut-out: 770x480 drain: 3½"		1179 061 rh 1179 062 lh	
Picture shows lh version				
Accessories: M N2 R T4 (page 57)				
Cabinet 45 	AISI 304 brushed dimensions: 440x500 1 bowl: 360x360 cut-out: 420x480 drain: 2"		1144 001 rh 1144 002 lh	
			1144 061 rh 1144 062 lh	
Picture shows lh version				
Version DX means right faucet hole, SX left faucet hole				
Cabinet 30 	AISI 304 brushed dimensions: 290x500 1 bowl: 240x340 cut-out: 270x480 drain: 2"		1129 000	

Standard fittings: fixing brackets, gasket (not available for under-mount sinks), waste fitting, overflow and siphon. Packing: single carton box.

S1000 Single bowl **NEW**

THE PRACTICALITY OF A LARGE BOWL



suggested mixer taps

Luisa
(8482 000 - pag. 101)

S1000 - Z66
(8448 500 - pag. 104)

	Features	Version	Ref.	Technical Drawing
--	----------	---------	------	-------------------

Cabinet 80



AISI 304 brushed
dimensions: **865x505**
1 bowl: **726x350**
cut-out: 840x480
drain: 3 1/2"



1180 150

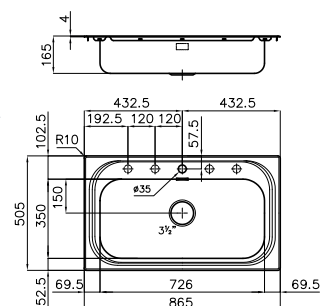

Accessories: **L5** **M** **M6** **T6**

Standard fittings: fixing brackets, gasket (not available for under-mount sinks), waste fitting, overflow and siphon. Packing: single carton box.

S1000 accessories

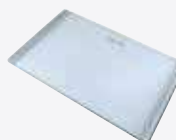

L5
Glass chopping board
29x54 cm
8633 300



M
Sliding chopping
board 30x54
8643 000



M6
Chopping
board 26x36,6 cm
8643 117



T6
St. steel dishes
holder 23x37 cm
8100 305



Undermount sinks

Stainless steel is always fashionable, and it blends perfectly in any worktop, be it granite, quartz or solid-surface. The large range of Foster undermount sinks, from those with “classical” design and wide radius to the minimalist ones with squared corners, makes it possible to choose according to everyone’s specific needs.

Milano p. 63



GK p. 65



Quadra p. 66



Quadra R10 p. 68



S4000 p. 70



KE p. 72



KE Gun Metal p. 76



KE Gold p. 78



KE Copper p. 79



Triplo invaso p. 80



S3000 p. 81



Big Bowl p. 83



Tornado p. 84



Elettra p. 85



Circolari p. 85



Notice for installation

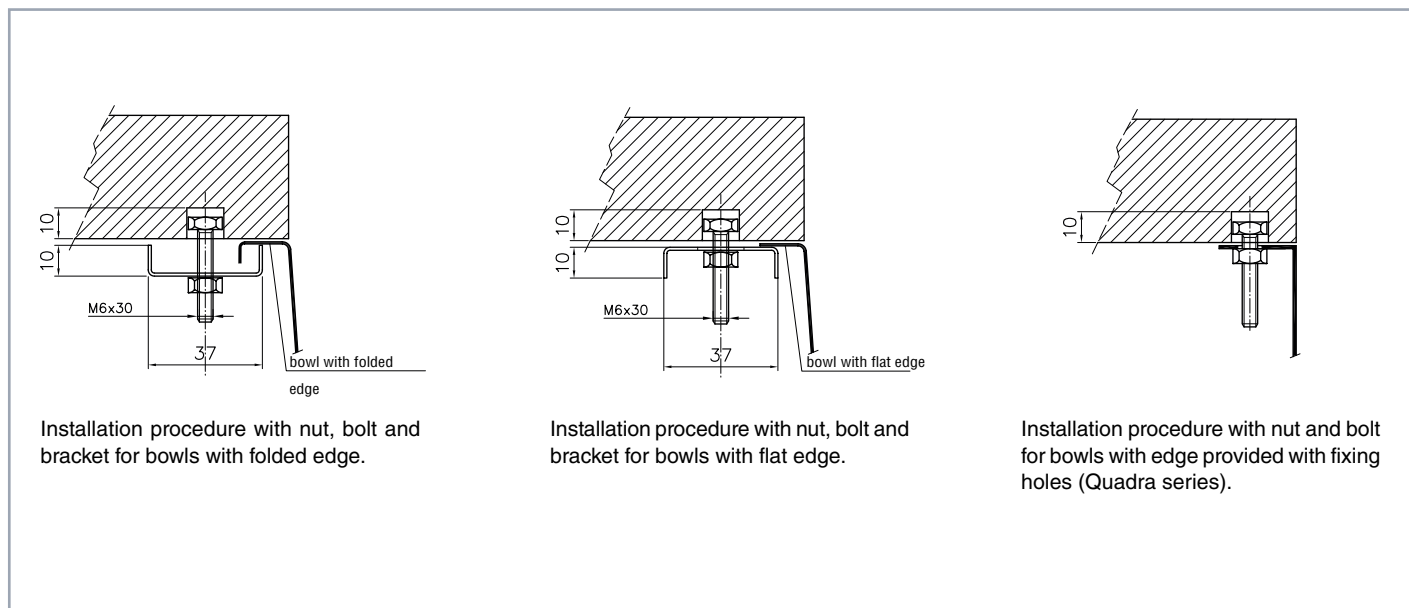

All models are supplied with installation kit (nut, bolt and bracket). The alternative use of different screws or bolts is left to the discretion of the installer.

Worktop drilling

The drawing with instruction to drill the worktop properly is included in the packing. The holes' dimension is to be considered merely as the manufacturer's suggestion. Small adjustments can be adopted on the basis of need or preference of the user, as per the attached schemes.

Compatibility of accessories

NOTICE: the compatibility of the accessories is assured only if the manufacturer's drilling instructions are respected (drilling at bowl's edge).

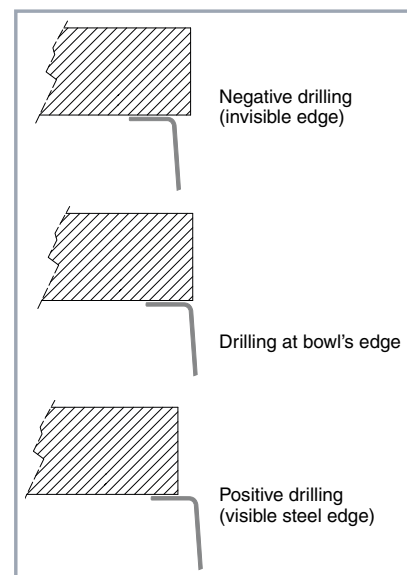

Foster offers its assistance for drilling the worktop properly with dwg drawings, now available for downloading on our website www.fosterspa.com on the product specifications page.

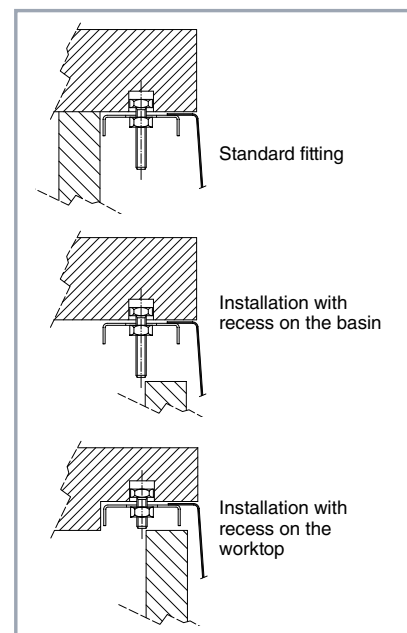





Cabinets

The cabinets' specifications shown for each model are referred only to the bowls' overall dimensions, and do not take into account the fixing systems. Different overall dimensions correspond to different installation methods. Moreover, these are negligible if kept within the thickness of the worktop, by creating a proper nook. It is therefore recommended to check beforehand for possible interferences.

Milano NEW

AN INNOVATIVE CONCEPT OF FUNCTIONALITY

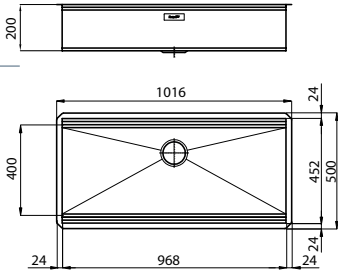

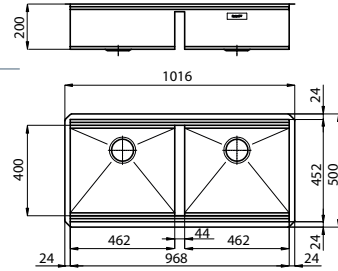
	Features	Version	Ref.	Technical Drawing
<p>Cabinet 120</p>  <p>Accessories: (page 64) M6 P3 L4 N3 P2 T2 Z2 PS</p>	<p>AISI 304 brushed bowl: 968x400 dimensions: 1016x500 cut-out: 968x452 drain: SPACE 3½"</p>	<p> ST</p>	<p>1015 850</p>	
<p>Cabinet 120</p>  <p>Accessories: (page 64) M6 P3 L4 N3 P2 T2 Z2 PS</p>	<p>AISI 304 brushed 2 bowls: 462x400 dimensions: 1016x500 cut-out: 968x452 drain: SPACE 3½"</p>	<p> ST</p>	<p>1016 850</p>	



Black grids configurations edge positioning



Black grids configurations bottom positioning

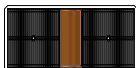



Black grids configurations edge positioning



Black grids configurations bottom positioning

Standard fittings: fixing brackets, gasket (not available for under-mount sinks), waste fitting, overflow and siphon. Packing: single carton box.

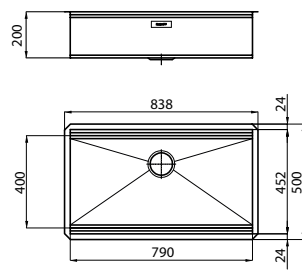
Milano NEW

	Features	Version	Ref.	Technical Drawing
Cabinet 90 	AISI 304 brushed bowl: 790x400 dimensions: 838x500 cut-out: 790x452 drain: SPACE 3½"	 ST	1014 850	
Accessories: M6 P3 L4 N3 P2 T2 Z2 PS	 Black grids configurations edge positioning	 Black grids configurations bottom positioning		
Cabinet 60 	AISI 304 brushed bowl: 462x400 dimensions: 510x500 cut-out: 462x452 drain: SPACE 3½"	 ST	1013 850	
Accessories: M6 P3 L4 N3 P2 T2 Z2 PS	 Black grids configurations edge positioning	 Black grids configurations bottom positioning		

Standard fittings: fixing brackets, gasket (not available for under-mount sinks), waste fitting, overflow and siphon. Packing: single carton box.



Three steps system

The Foster Milano sink has an ingenious design that makes it simple to use a large set of optional accessories. On the first supporting step, the topmost one, the innovative Black grids slide, creating a large and practical surface to rinse food and crockery.



Complete range of accessories

The second step is meant to support and allow the sliding of a complete combination of accessories, which make some operation practical and safe: rinse, drain, slice, grate... everything can be done inside the sink.



Protection grid on the bottom









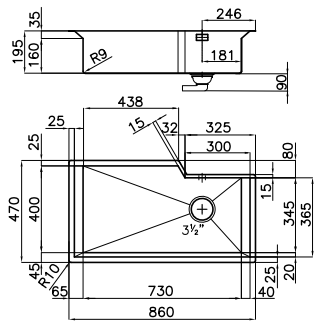

The third supporting step is on the bottom of the bowl. On this step rest the Black grids, making it possible to rinse foodstuffs without their coming in contact with the bottom of the sink, which may be dirty.

accessories

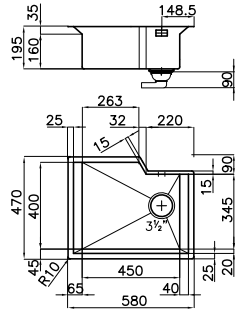
 <p>L4 Glass chopping board 23x41 cm 8631 300</p>	 <p>M6 Nut wood chopping board 18x44,8 cm 8642 000</p>	 <p>N3 HDPE Twin chopping board 31,7x42,5 cm 8644 101</p>	 <p>PS Milano Space automatic drain 8407 115</p>
 <p>P2 * Grating kit complete with ring support and food collection tray 8159 101</p>	 <p>P3 Black grid 39,2x44,8 cm 8100 600</p>	 <p>T2 * St. steel dishes holder 21,4x37,9 cm 8100 303</p>	 <p>Z2 * St. steel perforated pan 21,5x38 cm 8151 000</p>

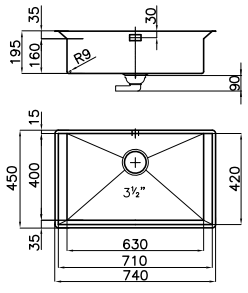



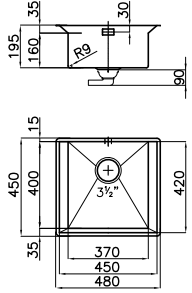

*To use only with N3 chopping board

GK









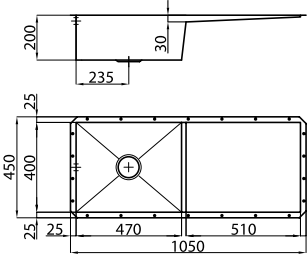

	Features	Version	Ref.	Technical Drawing
<p>Cabinet 90</p> 	<p>AISI 304 brushed bowl: 73x40 cm dimensions: 860x470 cut-out: see web site drain: SPACE 3½"</p>		<p>1401 800</p>	
<p>Accessories: M4 N4 T2 P2 Z2 Automatic waste fitting: PA PE PM (page 86)</p>				
<p>Cabinet 60</p> 	<p>AISI 304 brushed bowl: 45x40 cm dimensions: 580x470 cut-out: see web site drain: SPACE 3½"</p>		<p>1403 800</p>	
<p>Accessories: M4 N4 T2 P2 Z2 Automatic waste fitting: PA PE PM (page 86)</p>				
<p>Cabinet 80</p> 	<p>AISI 304 brushed bowl: 63x40 cm dimensions: 740x450 cut-out: see web site drain: SPACE 3½"</p>		<p>1404 800</p>	
	<p>AISI 304 vintage bowl: 63x40 cm dimensions: 740x450 cut-out: see web site drain: SPACE 3½"</p>	 	<p>1404 880</p>	
<p>Accessories: M4 N4 T2 P2 Z2 to be used only with chopping board N4 Automatic waste fitting: PA PE PM (page 86)</p>				
<p>Cabinet 60</p> 	<p>AISI 304 brushed bowl: 37x40 cm dimensions: 480x450 cut-out: see web site drain: SPACE 3½"</p>		<p>1405 800</p>	
<p>Accessories: M4 N4 T2 P2 Z2 to be used only with chopping board N4 Automatic waste fitting: PA PE PM (page 86)</p>				

Standard fittings: fixing brackets, gasket (not available for under-mount sinks), waste fitting, overflow and siphon. Packing: single carton box.

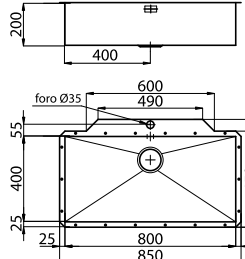
accessories

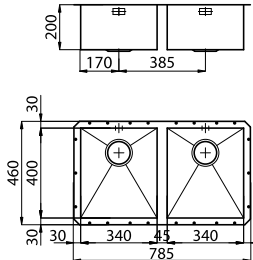

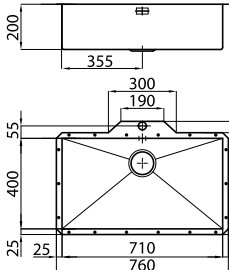

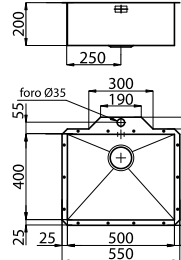

 <p>M4 Iroko chopping board 8656 001</p>	 <p>N4 HDPE Twin chopping board 8644 100</p>	 <p>T2 St. steel dishes holder 25x42,5 cm 8100 303</p>	 <p>P2 Grating kit complete with ring support and food collection bowl 8159 101</p>	 <p>Z2 St. steel perforated pan 8151 000</p>	 <p>PA Automatic waste fitting 8407 108</p>
--	--	--	--	--	---

Quadra

	Features	Version	Ref.	Technical Drawing
<p>Cabinet 120</p>  <p>Accessories: (page 68) L1 L3 L4 N2 N3 O2 P2 S T T1 T2 Z Z2</p> <p>Automatic waste fitting: PA PE PM (page 86)</p>	<p>AISI 304 brushed bowl: 47x40 cm dimension: 1050x450 cut-out: see web site drain: 3½"</p>	<p> ST</p>	<p>1210 850</p>	
<p>Cabinet 90</p>  <p>Accessories: L1 L3 L4 N2 N3 O2 P2 S T T1 T2 Z Z2</p> <p>Automatic waste fitting: PA PE PM (page 86)</p>	<p>AISI 304 brushed bowl: 80x40 cm dimensions: 850x505 cut-out: see web site drain: 3½"</p>	<p> ST</p>	<p>1218 850</p>	
<p>Cabinet 80</p>  <p>Accessories: L1 L4 N2 N3 O2 P2 R T1 T2 Z Z2</p> <p>Automatic waste fitting: PA PE PM (page 86)</p>	<p>AISI 304 brushed bowl: (2x) 34x40 cm dimensions: 785x460 cut-out: see web site drain: 3½"</p>	<p> ST</p>	<p>1208 850</p>	
<p>Cabinet 80</p>  <p>Accessories: L1 L3 L4 N2 N3 O2 P2 S T T1 T2 Z Z2</p> <p>Automatic waste fitting: PA PE PM (page 86)</p>	<p>AISI 304 brushed bowl: 71x40 cm dimensions: 760x500 cut-out: see web site drain: 3½"</p>	<p> ST</p>	<p>1217 850</p>	
<p>Cabinet 60</p>  <p>Accessories: L1 L3 L4 N2 N3 O2 P2 S T T1 T2 Z Z2</p> <p>Automatic waste fitting: PA PE PM (page 86)</p>	<p>AISI 304 brushed bowl: 50x40 cm dimensions: 550x505 cut-out: see web site drain: 3½"</p>	<p> ST</p>	<p>1215 850</p>	

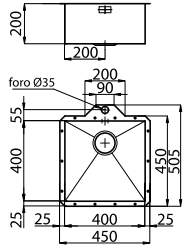
Standard fittings: fixing brackets, gasket (not available for under-mount sinks), waste fitting, overflow and siphon. Packing: single carton box.

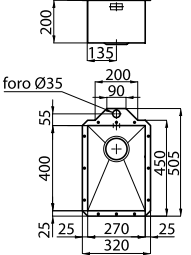
Quadra

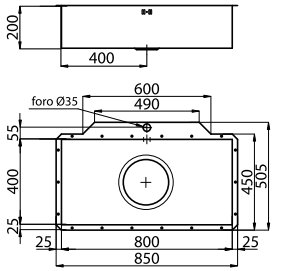
	Features	Version	Ref.	Technical Drawing
Cabinet 45 	AISI 304 brushed bowl: 40x40 cm dimensions: 450x505 cut-out: see web site drain: 3½"		1214 850	
Accessories: L1 L3 L4 N2 N3 O2 P2 S T T1 T2 Z Z2 Automatic waste fitting: PA PE PM (page 86)				
Cabinet 40 	AISI 304 brushed bowl: 27x40 cm dimensions: 320x505 cut-out: see web site drain: 3½"		1202 850	
Accessories: L4 N2 O2 T1 Automatic waste fitting: PA PE PM (page 86)				
Quadra 7" Cabinet 90 	AISI 304 brushed bowl: 80x40 cm dimensions: 850x505 cut-out: see web site drain: 7"		1218 897	
Accessories: L3 L4 N2 O2 S T T1 Z Standard fittings: fixing brackets, gasket (not available for under-mount sinks), waste fitting, overflow and siphon. Packing: single carton box.				

accessories

 <p>L1 Twin chopping board 31,7x42,5 cm 8644 041</p>	 <p>L3 Twin chopping board 41x41 cm 8644 004</p>		
 <p>L4 Glass chopping board 23x41 cm 8631 300</p>	 <p>N2 HDPE chopping board 27,2x42,5 cm 8657 001</p>	 <p>N3 HDPE Twin chopping board 31,7x42,5 cm 8644 101</p>	 <p>O2 White plastic bowl 27,2x41,4 cm 8153 100</p>
 <p>P2 ** Grating kit complete with ring support and food collection tray 8159 101</p>	 <p>R St. steel basket 34x40 cm 8611 000</p>	 <p>S St. steel basket 40x40 8612 000 White basket 40x40 8612 100</p>	 <p>T * St. steel dishes holder 25x35 cm 8100 154</p>
 <p>T1 St. steel dishes holder 25x42,5 cm 8100 201</p>	 <p>T2 ** St. steel dishes holder 21,4x37,9 cm 8100 303</p>	 <p>Z * St. steel colander 25x36 cm 8154 000</p>	 <p>Z2 ** St. steel perforated pan 21,5x38 cm 8151 000</p>

*To use only with L3 chopping board **To use only with N3 chopping board

Quadra R10

FORMAL PURITY WITHOUT SACRIFICING PRACTICALITY



Tre Alto
(8468 000 - pag. 98)



Geo
(8454 000 - pag. 97)

suggested mixer taps

	Features	Version	Ref.	Technical Drawing
--	----------	---------	------	-------------------

Cabinet 80



AISI 304 brushed
bowl: **71x40 cm**
dimensions: 736x426
cut-out: see web site
drain: 3½"



2307 890

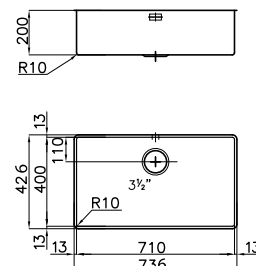

Accessories:

L1 L3 L4 N2 N3 O2 P2 S T T1 T2 Z Z2

Automatic waste fitting: PA PE PM (page 86)

Cabinet 60



AISI 304 brushed
bowl: **50x40 cm**
dimensions: 526x426
cut-out: see web site
drain: 3½"



2305 890

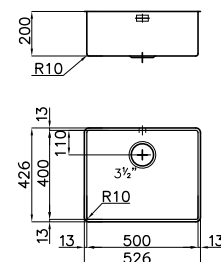

Accessories:

L1 L3 L4 N2 N3 O2 P2 S T T1 T2 Z Z2

Automatic waste fitting: PA PE PM (page 86)

Cabinet 60



AISI 304 brushed
bowl: **45x40 cm**
dimensions: 476x426
cut-out: see web site
drain: 3½"



2304 890

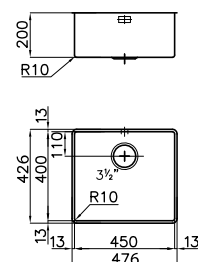

Accessories:

L1 L3 L4 N2 N3 O2 P2 S T T1 T2 Z Z2

Automatic waste fitting: PA PE PM (page 86)

Standard fittings: fixing brackets, gasket (not available for under-mount sinks), waste fitting, overflow and siphon. Packing: single carton box.

Quadra R10

Features	Version	Ref.	Technical Drawing
----------	---------	------	-------------------

Cabinet 45



AISI 304 brushed bowl: **38x40 cm**
 dimensions: 406x426
 cut-out: see web site
 drain: 3½"



2303 890

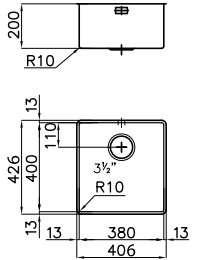

Accessories:

L1 L4 N2 N3 O2 P2 R T1 T2 Z2

Automatic waste fitting: PA PE PM (page 86)

Standard fittings: fixing brackets, gasket (not available for under-mount sinks), waste fitting, overflow and siphon. Packing: single carton box.



Detail of the elegant perimetric overflow that enhance the design of the sink.

accessories

 <p>L1 Twin chopping board 31,7x42,5 cm 8644 041</p>	 <p>L3 Twin chopping board 41x41 cm 8644 004</p>		
 <p>L4 Glass chopping board 23x41 cm 8631 300</p>	 <p>N2 HDPE chopping board 27,2x42,5 cm 8657 001</p>	 <p>N3 HDPE Twin chopping board 31,7x42,5 cm 8644 101</p>	 <p>O2 White plastic bowl 27,2x41,4 cm 8153 100</p>
 <p>P2 ** Grating kit complete with ring support and food collection tray 8159 101</p>	 <p>R St. steel basket 34x40 cm 8611 000</p>	 <p>S St. steel basket 40x40 8612 000 White basket 40x40 8612 100</p>	 <p>T * St. steel dishes holder 25x35 cm 8100 154</p>
 <p>T1 St. steel dishes holder 25x42,5 cm 8100 201</p>	 <p>T2 ** St. steel dishes holder 21,4x37,9 cm 8100 303</p>	 <p>Z * St. steel colander 25x36 cm 8154 000</p>	 <p>Z2 ** St. steel perforated pan 21,5x38 cm 8151 000</p>

*To use only with L3 chopping board **To use only with N3 chopping board

S4000 - R25

MINIMAL YET FUNCTIONAL



Perimetric overflow



NYC
(8486 000 - pag. 100)



Spring
(8472 000 - pag. 97)

suggested mixer taps

	Features	Version	Ref.	Technical Drawing
--	----------	---------	------	-------------------

Cabinet 80



AISI 304 brushed
bowl: **71x40 cm**
dimensions: 750x440
cut-out: see web site
drain: 3½"



1266 850

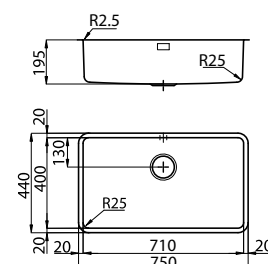

Accessories:

L1 L3 L4 N2 N3 O2 P2 S T T2 Z Z2

Automatic waste fitting: **PA PE PM** (page 86)

Cabinet 60



AISI 304 brushed
bowl: **53x40 cm**
dimensions: 580x450
cut-out: see web site
drain: 3½"



1265 850

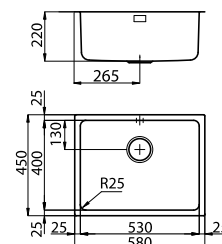

Accessories:

L1 L3 L4 N2 N3 O2 P2 S T T2 Z Z2

Automatic waste fitting: **PA PE PM** (page 86)

Cabinet 60



AISI 304 brushed
bowl: **45x40 cm**
dimensions: 490x440
cut-out: see web site
drain: 3½"



1263 850

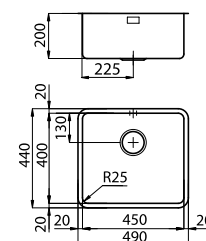





Accessories:

L1 L3 L4 N2 N3 O2 P2 S T T2 Z Z2

Automatic waste fitting: **PA PE PM** (page 86)

Standard fittings: fixing brackets, gasket (not available for under-mount sinks), waste fitting, overflow and siphon. Packing: single carton box.

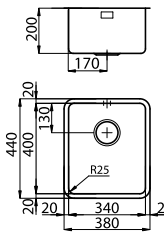
S4000 - R25

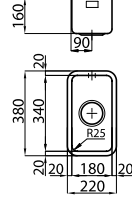
	Features	Version	Ref.	Technical Drawing
Cabinet 40 	AISI 304 brushed bowl: 34x40 cm dimensions: 380x440 cut-out: see web site drain: 3½"	 ST	1262 850	
Accessories: L4 N2 O2 R Automatic waste fitting: PA PE PM (page 86)				
Cabinet 30 	AISI 304 brushed bowl: 18x34 cm dimensions: 220x380 cut-out: see web site drain: 3½"	 ST	1260 850	
Automatic waste fitting: PA PE PM (page 86)				

Standard fittings: fixing brackets, gasket (not available for under-mount sinks), waste fitting, overflow and siphon. Packing: single carton box.

accessories

 <p>L1 Twin chopping board 31,7x42,5 cm 8644 041</p>	 <p>L3 Twin chopping board 41x41 cm 8644 004</p>		
 <p>L4 Glass chopping board 23x41 cm 8631 300</p>	 <p>N2 HDPE chopping board 27,2x42,5 cm 8657 001</p>	 <p>N3 HDPE Twin chopping board 31,7x42,5 cm 8644 101</p>	 <p>O2 White plastic bowl 27,2x41,4 cm 8153 100</p>
 <p>P2 ** Grating kit complete with ring support and food collection tray 8159 101</p>	 <p>R St. steel basket 34x40 cm 8611 000</p>	 <p>S St. steel basket 40x40 8612 000 White basket 40x40 8612 100</p>	 <p>T * St. steel dishes holder 25x35 cm 8100 154</p>
 <p>T1 St. steel dishes holder 25x42,5 cm 8100 201</p>	 <p>T2 ** St. steel dishes holder 21,4x37,9 cm 8100 303</p>	 <p>Z * St. steel colander 25x36 cm 8154 000</p>	 <p>Z2 ** St. steel perforated pan 21,5x38 cm 8151 000</p>

*To use only with L3 chopping board **To use only with N3 chopping board

KE - R15

THE RIGHT MODEL FOR EVERY NEED



Perimetric overflow



Camillo
(8467 000 - pag. 97)



Lorenzo
(8466 000 - pag. 100)



suggested mixer taps

	Features	Version	Ref.	Technical Drawing
--	----------	---------	------	-------------------

Cabinet 100



AISI 304 brushed
bowl: **45x40/40x40 cm**
dimensions: 930x450
cut-out: see web site
drain: 3½"

 **ST** 2207 850

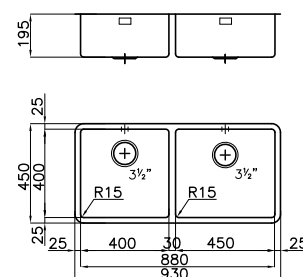

Accessories: (page 75)

L1 L3 N2 N3 O2 P2 S T T2 Z Z2

Automatic waste fitting: **PA PE PM** (page 86)

Cabinet 90



AISI 304 brushed
bowl: **40x40/34x40 cm**
dimensions: 820x450
cut-out: see web site
drain: 3½"

 **ST** 2206 850

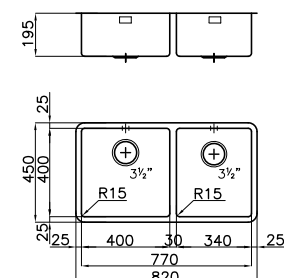

Accessories: (page 75)

L1 L3 N2 N3 O2 P2 S T T2 Z Z2

Automatic waste fitting: **PA PE PM** (page 86)

Cabinet 80



AISI 304 brushed
bowl: **45x40/27x40 cm**
dimensions: 800x450
cut-out: see web site
drain: 3½"

 **ST** 2205 850

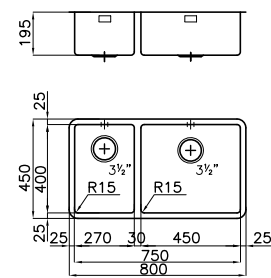

Accessories: (page 75)

L1 L3 N2 N3 O2 P2 S T T2 Z Z2

Automatic waste fitting: **PA PE PM** (page 86)









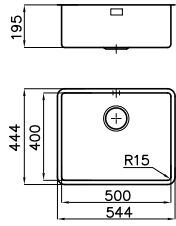

Standard fittings: fixing brackets, gasket (not available for under-mount sinks), waste fitting, overflow and siphon. Packing: single carton box.

KE - R15

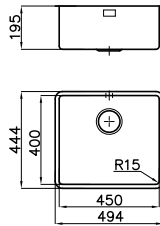
	Features	Version	Ref.	Technical Drawing
<p>Cabinet 80</p>   <p>Accessories: (page 76) L1 L3 L4 N2 N3 O2 P2 S T T2 Z Z2 Automatic waste fitting: PA PE PM (page 86)</p>	<p>AISI 304 brushed bowl: 50x40/18x40 cm dimensions: 760x450 cut-out: see web site drain: 3½"</p>		<p>2204 851 rh 2204 852 lh</p>	
<p>Cabinet 80</p>  <p>Accessories: (page 75) L1 L4 N2 N3 O2 P2 R T2 Z2 Automatic waste fitting: PA PE PM (page 86)</p>	<p>AISI 304 brushed bowl: (2x) 34x40 cm dimensions: 760x450 cut-out: see web site drain: 3½"</p>		<p>2203 850</p>	
<p>Cabinet 80</p>   <p>Accessories: (page 75) L1 L3 L4 N2 N3 O2 P2 S T T2 Z Z2 Automatic waste fitting: PA PE PM (page 86)</p>	<p>AISI 304 brushed bowl: 40x40/18x40 cm dimensions: 660x450 cut-out: see web site drain: 3½"</p>		<p>2202 851 rh 2202 852 lh</p>	
<p>Cabinet 60</p>  <p><i>Picture shows lh version</i></p> <p>Accessories: (page 75) L1 L4 N2 N3 O2 P2 R T2 Z2 Automatic waste fitting: PA PE PM (page 86)</p>	<p>AISI 304 brushed bowl: 34x40/18x40 cm dimensions: 585x440 cut-out: see web site drain: 3½"</p>		<p>2201 851 rh 2201 852 lh</p>	
<p>Cabinet 80</p>  <p>Accessories: (page 75) L1 L3 L4 N2 N3 O2 P2 S T T2 Z Z2 Automatic waste fitting: PA PE PM (page 86)</p>	<p>AISI 304 brushed bowl: 71x40 cm dimensions: 750x440 cut-out: see web site drain: 3½"</p>		<p>2157 850</p>	

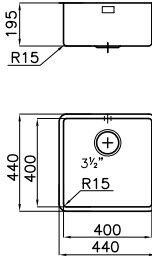
Standard fittings: fixing brackets, gasket (not available for under-mount sinks), waste fitting, overflow and siphon. Packing: single carton box.

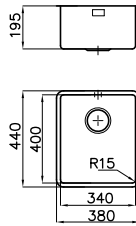
KE - R15

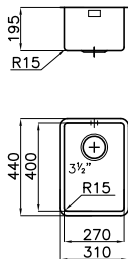
	Features	Version	Ref.	Technical Drawing
<p>Cabinet 60</p>  <p>Accessories: L1 L3 L4 N2 N3 O2 P2 S T T2 Z Z2 Automatic waste fitting: PA PE PM (page 86)</p>	<p>AISI 304 brushed bowl: 50x40 cm dimensions: 544x444 cut-out: see web site drain: 3½</p>		<p>2155 850</p>	
<p>Cabinet 60</p>  <p>Accessories: L1 L3 L4 N2 N3 O2 P2 S T T2 Z Z2 Automatic waste fitting: PA PE PM (page 86)</p>	<p>AISI 304 brushed bowl: 45x40 cm dimensions: 494x444 cut-out: see web site drain: 3½</p>		<p>2154 850</p>	
<p>Cabinet 45</p>  <p>Accessories: L1 L3 L4 N2 N3 O2 P2 S T T2 Z Z2 Automatic waste fitting: PA PE PM (page 86)</p>	<p>AISI 304 brushed bowl: 40x40 cm dimensions: 440x440 cut-out: see web site drain: 3½</p>		<p>2156 850</p>	
<p>Cabinet 40</p>  <p>Accessories: L1 L4 N2 N3 O2 P2 R T2 Z2 Automatic waste fitting: PA PE PM (page 86)</p>	<p>AISI 304 brushed bowl: 34x40 cm dimensions: 380x440 cut-out: see web site drain: 3½</p>		<p>2153 850</p>	
<p>Cabinet 40</p>  <p>Accessories: L4 N2 Automatic waste fitting: PA PE PM (page 86)</p>	<p>AISI 304 brushed bowl: 27x40 cm dimensions: 310x440 cut-out: see web site drain: 3½</p>		<p>2152 850</p>	

Standard fittings: fixing brackets, gasket (not available for under-mount sinks), waste fitting, overflow and siphon. Packing: single carton box.

KE - R15

Features	Version	Ref.	Technical Drawing
----------	---------	------	-------------------

Cabinet 30



AISI 304 brushed
 bowl: **18x40 cm**
 dimensions: 222x442
 cut-out: see web site
 drain: 3½"



2151 850

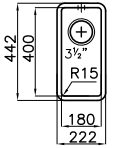
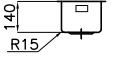

Automatic waste fitting: **PA PE PM** (page 86)

Standard fittings: fixing brackets, gasket (not available for under-mount sinks), waste fitting, overflow and siphon. Packing: single carton box.

accessories

 <p>L1 Twin chopping board 31,7x42,5 cm 8644 041</p>	 <p>L3 Twin chopping board 41x41 cm 8644 004</p>		
 <p>L4 Glass chopping board 23x41 cm 8631 300</p>	 <p>N2 HDPE chopping board 27,2x42,5 cm 8657 001</p>	 <p>N3 HDPE Twin chopping board 31,7x42,5 cm 8644 101</p>	 <p>O2 White plastic bowl 27,2x41,4 cm 8153 100</p>
 <p>P2 ** Grating kit complete with ring support and food collection tray 8159 101</p>	 <p>R St. steel basket 34x40 cm 8611 000</p>	 <p>S St. steel basket 40x40 8612 000 White basket 40x40 8612 100</p>	 <p>T * St. steel dishes holder 25x35 cm 8100 154</p>
 <p>T1 St. steel dishes holder 25x42,5 cm 8100 201</p>	 <p>T2 ** St. steel dishes holder 21,4x37,9 cm 8100 303</p>	 <p>Z * St. steel colander 25x36 cm 8154 000</p>	 <p>Z2 ** St. steel perforated pan 21,5x38 cm 8151 000</p>

*To use only with L3 chopping board **To use only with N3 chopping board





KE Color



Perimetric overflow

Gun Metal, Gold, copper. The new KE Colour finishes are obtained with a special surface treatment (**Physical Vapour Deposition**) that gives AISI 304 stainless steel the fine colour and a subtle sheen in addition to very high physical and mechanical characteristics. In particular, the treatment gives the steel a higher **resistance to corrosion**; it also increases the **surface hardness**, and therefore obtains a greater **resistance to scratches**; it reduces surface friction and **improves water flow** and **temperature resistance**.

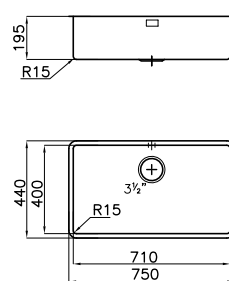
KE Gun Metal

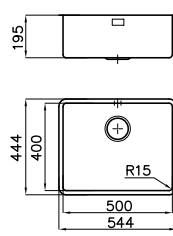
	Features	Version	Ref.	Technical Drawing
Cabinet 80 	AISI 304 Gun Metal bowl: 71x40 cm dimensions: 750x440 cut-out: see web site drain: 3½		2157 856	
Accessories: L1 L3 L4 N2 N3 O2 P2 S T T2 Z Z2 Automatic waste fitting: PA PE PM (page 86)				
Cabinet 60 	AISI 304 Gun Metal bowl: 50x40 cm dimensions: 544x444 cut-out: see web site drain: 3½		2155 856	
Accessories: L1 L3 L4 N2 N3 O2 P2 S T T2 Z Z2 Automatic waste fitting: PA PE PM (page 86)				

KE Gun Metal NEW

	Features	Version	Ref.	Technical Drawing
Cabinet 45 	AISI 304 Gun Metal bowl: 40x40 cm dimensions: 440x440 cut-out: see web site drain: 3½	 ST	2156 856	
Accessories: L1 L3 L4 N2 N3 O2 P2 S T T2 Z Z2 Automatic waste fitting: PA PE PM (page 86)				
Cabinet 40 	AISI 304 Gun Metal bowl: 34x40 cm dimensions: 380x440 cut-out: see web site drain: 3½	 ST	2153 856	
Accessories: L1 L4 N2 N3 O2 P2 R T2 Z2 Automatic waste fitting: PA PE PM (page 86)				
Cabinet 30 	AISI 304 Gun Metal bowl: 18x40 cm dimensions: 222x442 cut-out: see web site drain: 3½	 ST	2151 856	
Automatic waste fitting: PA PE PM (page 86)				







Standard fittings: fixing brackets, gasket (not available for under-mount sinks), waste fitting, overflow and siphon. Packing: single carton box.

accessories

 <p>L1 Twin chopping board 31,7x42,5 cm 8644 041</p>	 <p>L3 Twin chopping board 41x41 cm 8644 004</p>	 <p>PG NEW Gun metal automatic drain 8407110</p>	 <p>Gun Metal mixer taps pages 101-102 Dispenser page 106</p>
 <p>L4 Glass chopping board 23x41 cm 8631 300</p>	 <p>N2 HDPE chopping board 27,2x42,5 cm 8657 001</p>	 <p>N3 HDPE Twin chopping board 31,7x42,5 cm 8644 101</p>	 <p>O2 White plastic bowl 27,2x41,4 cm 8153 100</p>
 <p>P2 ** Grating kit complete with ring support and food collection tray 8159 101</p>	 <p>R St. steel basket 34x40 cm 8611 000</p>	 <p>S St. steel basket 40x40 8612 000 White basket 40x40 8612 100</p>	 <p>T * St. steel dishes holder 25x35 cm 8100 154</p>
 <p>T1 St. steel dishes holder 25x42,5 cm 8100 201</p>	 <p>T2 ** St. steel dishes holder 21,4x37,9 cm 8100 303</p>	 <p>Z * St. steel colander 25x36 cm 8154 000</p>	 <p>Z2 ** St. steel perforated pan 21,5x38 cm 8151 000</p>

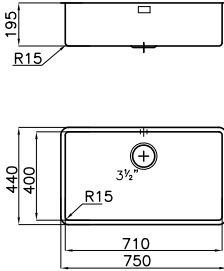
*To use only with L3 chopping board **To use only with N3 chopping board

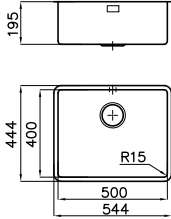
KE Gold NEW

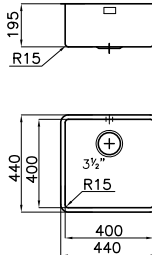
	Features	Version	Ref.	Technical Drawing
Cabinet 80 	AISI 304 Gun Metal bowl: 71x40 cm dimensions: 750x440 cut-out: see web site drain: 3½		2157 859	
Accessories: L1 L3 L4 N2 N3 O2 P2 S T T2 Z Z2 Automatic waste fitting: PA PE PM (page 86)				
Cabinet 60 	AISI 304 Gun Metal bowl: 50x40 cm dimensions: 544x444 cut-out: see web site drain: 3½		2155 859	
Accessories: L1 L3 L4 N2 N3 O2 P2 S T T2 Z Z2 Automatic waste fitting: PA PE PM (page 86)				
Cabinet 45 	AISI 304 Gun Metal bowl: 40x40 cm dimensions: 440x440 cut-out: see web site drain: 3½		2156 859	
Accessories: L1 L3 L4 N2 N3 O2 P2 S T T2 Z Z2 Automatic waste fitting: PA PE PM (page 86)				







Standard fittings: fixing brackets, gasket (not available for under-mount sinks), waste fitting, overflow and siphon. Packing: single carton box.

accessories

 <p>L1 Twin chopping board 31,7x42,5 cm 8644 041</p>	 <p>L3 Twin chopping board 41x41 cm 8644 004</p>	 <p>L4 Glass chopping board 23x41 cm 8631 300</p>	 <p>N2 HDPE chopping board 27,2x42,5 cm 8657 001</p>	 <p>N3 HDPE Twin chopping board 31,7x42,5 cm 8644 101</p>	 <p>O2 White plastic bowl 27,2x41,4 cm 8153 100</p>		
 <p>P2 ** Grating kit complete with ring support and food collection tray 8159 101</p>	 <p>R St. steel basket 34x40 cm 8611 000</p>	 <p>S St. steel basket 40x40 8612 000 White basket 40x40 8612 100</p>	 <p>T * St. steel dishes holder 25x35 cm 8100 154</p>	 <p>T1 St. steel dishes holder 25x42,5 cm 8100 201</p>	 <p>T2 ** St. steel dishes holder 21,4x37,9 cm 8100 303</p>	 <p>Z * St. steel colander 25x36 cm 8154 000</p>	 <p>Z2 ** St. steel perforated pan 21,5x38 cm 8151 000</p>

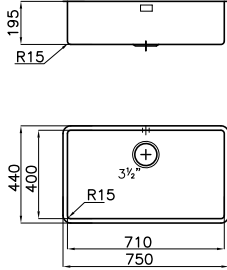

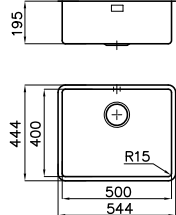
*To use only with L3 chopping board **To use only with N3 chopping board

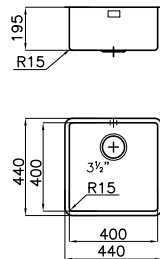
KE Copper NEW

Features	Version	Ref.	Technical Drawing
Cabinet 80  AISI 304 Copper bowl: 71x40 cm dimensions: 750x440 cut-out: see web site drain: 3½	 ST	2157 858	
Accessories: L1 L3 L4 N2 N3 O2 P2 S T T2 Z Z2 Automatic waste fitting: PA PE PM (page 86)			
Cabinet 60  AISI 304 Copper bowl: 50x40 cm dimensions: 544x444 cut-out: see web site drain: 3½	 ST	2155 858	
Accessories: L1 L3 L4 N2 N3 O2 P2 S T T2 Z Z2 Automatic waste fitting: PA PE PM (page 86)			
Cabinet 45  AISI 304 Copper bowl: 40x40 cm dimensions: 440x440 cut-out: see web site drain: 3½	 ST	2156 858	
Accessories: L1 L3 L4 N2 N3 O2 P2 S T T2 Z Z2 Automatic waste fitting: PA PE PM (page 86)			

Standard fittings: fixing brackets, gasket (not available for under-mount sinks), waste fitting, overflow and siphon. Packing: single carton box.

accessories

 L1 Twin chopping board 31,7x42,5 cm 8644 041	 L3 Twin chopping board 41x41 cm 8644 004	 Copper mixer tap page 102
 L4 Glass chopping board 23x41 cm 8631 300	 N2 HDPE chopping board 27,2x42,5 cm 8657 001	 N3 HDPE Twin chopping board 31,7x42,5 cm 8644 101
 O2 White plastic bowl 27,2x41,4 cm 8153 100	 P2 ** Grating kit complete with ring support and food collection tray 8159 101	 R St. steel basket 34x40 cm 8611 000
 S St. steel basket 40x40 8612 000 White basket 40x40 8612 100	 T * St. steel dishes holder 25x35 cm 8100 154	 T1 St. steel dishes holder 25x42,5 cm 8100 201
 T2 ** St. steel dishes holder 21,4x37,9 cm 8100 303	 Z * St. steel colander 25x36 cm 8154 000	 Z2 ** St. steel perforated pan 21,5x38 cm 8151 000

*To use only with L3 chopping board **To use only with N3 chopping board

Triplo Invaso

Features	Version	Ref.	Technical Drawing
----------	---------	------	-------------------

Cabinet 90



AISI 304 brushed bowl: **71x40 cm**
 dimensions: 860x540
 cut-out: see web site
 drain: **automatic SPACE 3½"**



1490 860

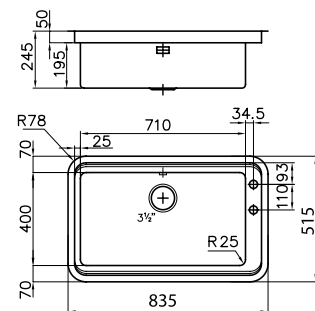

Accessories: **L4 M2 M3 O2 S U2**

Cabinet 90



AISI 304 brushed bowls: **50x40/23x34 cm**
 dimensions: 860x540
 cut-out: see web site
 drain: **automatic 3½"**



1488 861 rh
 1488 862 lh

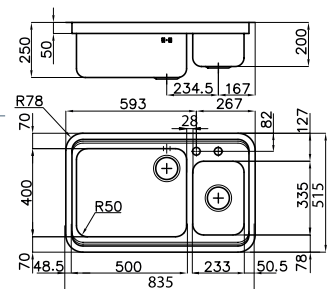

Picture shows lh version

Accessories: **M2 M3 N2 O2 S U2 T4 Z**

Standard fittings: fixing brackets, gasket (not available for under-mount sinks), waste fitting, overflow and siphon. Packing: single carton box.

Sliding accessoires

The undermount solution exalts the particular feature of Triplo Invaso sink which is able to contain different sliding accessories.



accessories



M2
 Chopping board 28x48
 8643 115



M3
 Sliding chopping board 28x48
 8643 116



N2
 HDPE chopping board
 27,2x42,5 cm
 8657 001



O2
 White plastic bowl
 27,2x41,4 cm
 8153 100



S
 St. steel basket 40x40
 8612 000

White basket 40x40
 8612 100



U2
 St. steel dishes holder 23x47
 8100 115



Z
 St. steel colander
 25x36 cm
 8154 000



T4
 St. steel dishes holder 25x43 cm
 8100 301

S3000

	Features	Version	Ref.			Technical Drawing
--	----------	---------	------	--	--	-------------------

Cabinet 60



Picture shows rh version

Accessories: **L4 N2 O2 S**
Automatic waste fitting: **PR PQ PC** (page 86)

AISI 304 brushed
bowl: **50x40 cm**
dimensions: 539x436
cut-out: see web site
drain: 3½"



1116 861 rh
1116 862 lh

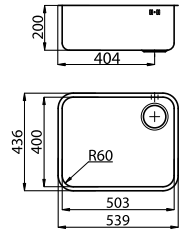

Cabinet 45



Picture shows rh version

Accessories: **L4 N2 O2 S**
Automatic waste fitting: **PR PQ PC** (page 86)

AISI 304 brushed
bowl: **40x40 cm**
dimensions: 441x441
cut-out: see web site
drain: 3½"



1114 861 rh
1114 862 lh

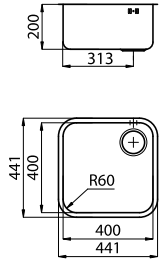

Cabinet 40



Picture shows rh version

Accessories: **A L4 N2 O2 R**
Automatic waste fitting: **PR PQ PC** (page 86)

AISI 304 brushed
bowl: **34x40 cm**
dimensions: 381x441
cut-out: see web site
drain: 3½"



1117 861 rh
1117 862 lh

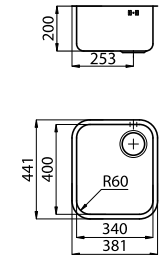

Cabinet 80



Accessories: **A L4 N2 O2 R**
Automatic waste fitting: **PR PQ PC** (page 86)

AISI 304 brushed
bowl: **(2x) 34x40 cm**
dimensions: 761x446
cut-out: see web site
drain: 3½"



1302 860

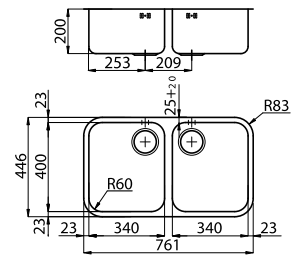

Cabinet 60



Picture shows rh version

Accessories: **A N2 O2 Q R**
Automatic waste fitting: **PR PQ PC** (page 86)

AISI 304 brushed
bowl: **34x40/15x30 cm**
dimensions: 580x460
cut-out: see web site
drain: 3½"





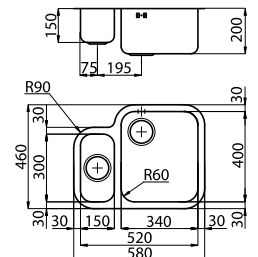

1309 861 rh
1309 862 lh

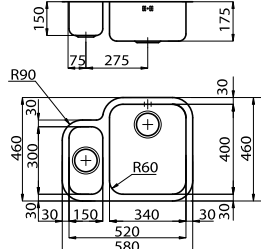

Standard fittings: fixing brackets, gasket (not available for under-mount sinks), waste fitting, overflow and siphon. Packing: single carton box.
For rh/lh version on main bowl with drain on right/left side.

S3000

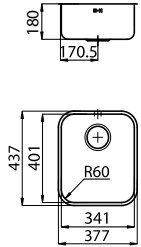

	Features	Version	Ref.	Technical Drawing
Cabinet 60 	AISI 304 brushed bowl: 34x40/15x30 cm dimensions: 580x460 cut-out: see web site drain: 3½"	 ST	1308 861 rh 1308 862 lh	
Picture shows rh version Accessories: A N2 O2 Q R Automatic waste fitting: PR PQ PC (page 86)				



Cabinet 40 	AISI 304 brushed bowl: 34x40 cm dimensions: 377x437 cut-out: see web site drain: 3½"	 ST	1307 860	
Accessories: A N2 O2 R Automatic waste fitting: PR PQ PC (page 86) Standard fittings: fixing brackets, gasket (not available for under-mount sinks), waste fitting, overflow and siphon. Packing: single carton box.				

accessories

 <p>A Chopping board 34x40 8647 000</p>	 <p>L4 Glass chopping board 23x41 cm 8631 300</p>	 <p>N2 HDPE chopping board 27,2x42,5 cm 8657 001</p>	
 <p>O2 White plastic bowl 27,2x41,4 cm 8153 100</p>	 <p>Q White colander 17x32 cm 8151 100</p>	 <p>R St. steel basket 34x40 cm 8611 000</p>	 <p>S St. steel basket 40x40 8612 000</p> <p>White basket 40x40 8612 100</p>

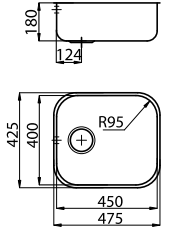

Big Bowl

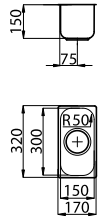
	Features	Version	Ref.	Technical Drawing
Cabinet 60 	AISI 304 brushed bowl: 45x40 cm dimensions: 475x425 cut-out: see web site drain: 3½"		1811 050	
Accessories: S Automatic waste fitting: PR PQ PC (page 86)				

Cabinet 30 	AISI 304 brushed bowl: 15x30 cm dimensions: 170x320 cut-out: see web site drain: 3½"		1300 068	
Automatic waste fitting: PR PQ PC (page 86)				

Standard fittings: fixing brackets, gasket (not available for under-mount sinks), waste fitting, overflow and siphon. Packing: single carton box.

Big Bowl Soft

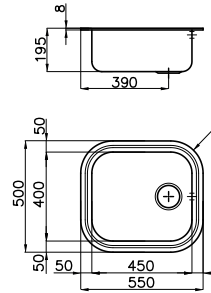
	Features	Version	Ref.	Technical Drawing
Cabinet 60 	AISI 304 brushed bowl: 45x40 cm dimensions: 550x500 cut-out: see web site drain: 3½"		1611 068	
Accessories: E L4 N2 S Automatic waste fitting: PR PQ PC (page 86)				
Standard fittings: fixing brackets, gasket (not available for under-mount sinks), waste fitting, overflow and siphon. Packing: single carton box.				

accessories



E
Chopping board 45x40
8655 000



L4
Glass chopping board
23x41 cm
8631 300



N2
HDPE chopping board
27,2x42,5 cm
8657 001



S
St. steel basket 40x40
8612 000

White basket 40x40
8612 100

Tornado

	Features	Version	Ref.		Technical Drawing
--	----------	---------	------	--	-------------------

Cabinet 80



AISI 304 brushed bowl: **73x44 cm**
 dimensions: 816x524
 cut-out: see web site
 drain: **automatic 3½"**

 **ST** 1679 860

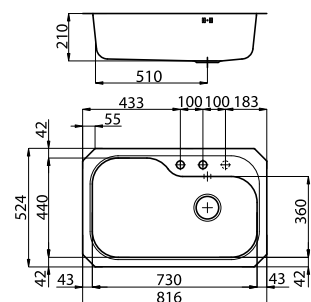

Third tap hole available

Accessories: **H I L2 O Q T U Z**

Sinuuous profile

The wide radius of the corners in undermount Tornado sink gives great elegance, which fits both to classic and to modern kitchens.



accessories

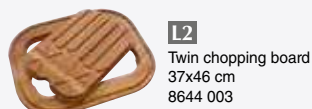
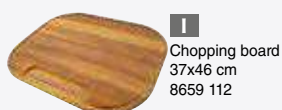
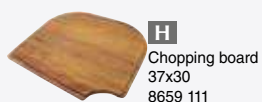

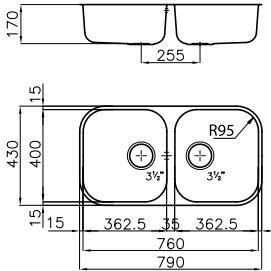

*to use only with L2 chopping board

Elettra

	Features	Version	Ref.	Technical Drawing
Cabinet 80 	AISI 304 brushed bowls: (2x) 36x40 cm dimensions: 790x430 cut-out: see web site drain: 3½"	 ST	1974 860	
Cabinet 45 	AISI 304 brushed bowl: 36x40 cm dimensions: 386,5x424 cut-out: see web site drain: 3½"	 ST	1970 860	

Standard fittings: fixing brackets, gasket (not available for under-mount sinks), waste fitting, overflow and siphon. Packing: single carton box.

Circolari

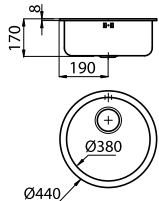
	Features	Version	Ref.	Technical Drawing
Cabinet 45 	AISI 304 brushed bowl: Ø 38 cm dimensions: Ø 440 cut-out: see web site drain: 3½"	 ST	1010 068	

Available for 3½" version only:
PR PQ PC (page 86)

Standard fittings: fixing brackets, gasket (not available for under-mount sinks), waste fitting, overflow and siphon. Packing: single carton box.

accessories

 <p>L4 Glass chopping board 23x41 cm 8631 300</p>	 <p>N2 HDPE chopping board 27,2x42,5 cm 8657 001</p>	 <p>R St. steel basket 34x40 cm 8611 000</p>	 <p>T4 St. steel dishes holder 25x43 cm 8100 301</p>
---	--	---	--

Complements

Automatic waste fitting

PS   

"Space Milano" automatic waste fitting with round rotating remote control and with perimeter overflow



NEW

Sigla		
8407 115		

PA   

"Space" automatic waste fitting with squared rotating remote control and with perimeter overflow

Ref.		
8407 108		

PE   

"Space" automatic waste fitting with round rotating remote control and with perimeter overflow

Ref.		
8407 109		

PM   

Automatic waste fitting with **squared** rotating remote control and with perimeter overflow



Ref.		
8407 113		

PG   

Gun metal automatic waste fitting with round remote control and with perimeter overflow

NEW

Sigla		
8407 110		

PR   

Automatic waste fitting with **round** remote control and with overflow

Ref.		
8407 100		



Automatic waste fitting with **round** remote control and without overflow

Ref.		
8407 000		

PQ   

Premium automatic waste fitting with **squared** remote control and with overflow

Ref.		
8407 102		

PC   

Premium automatic waste fitting with **cubic** remote control (push-pull) and with overflow

Ref.		
8407 103		

SPACE automatic waste fittings

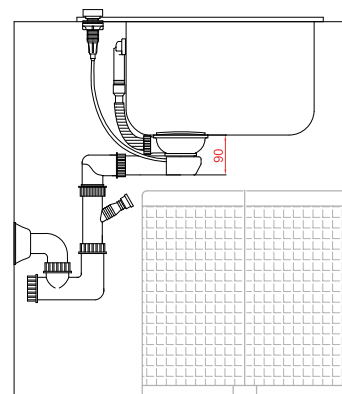

Designed for deep bowls, Space has a very small encumbrance. In the drawing the side view of the Space is shown. The height of the compact drain and the conformation of the siphon optimize the area under the sink leaving the necessary space for the needs of separate waste collecting.

Notes on compatibility of automatic drains

Automatic drains are compatible with sinks that are supplied with at least one second hole (in addition to the tap hole). For many sinks this is not a standard feature but it can be requested when ordering it. In the sinks drawings standard holes are shown with a continuous line, while positions for any holes on request are shown with a dashed line (see example below).

For undermount sinks the possibility of insertion of the automatic drain is always shown because the hole can be positioned on the worktop. It is also recommended to check the type of the overflow of the sink in order to choose a compatible automatic drain.

The drains PA, PE, PM with perimeter overflow are interchangeable.

The drains PR, PQ, PC with standard overflow are interchangeable.

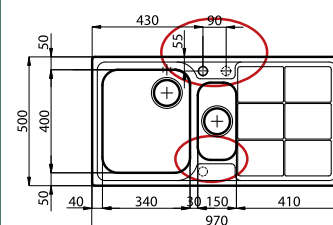





Second and third tap hole available







For installation on the worktop all the automatic waste fittings require hole Ø 35 mm.

Complements

3 1/2" SPACE Waste fittings

	Ref.	Description
	8403 008	"Space" waste fitting without overflow
	8403 308	"Space" waste fitting with perimetric overflow
	8403 315	"Space" waste fittings with special overflow for CQ sink
	8669 012	Steel Space plug with silicone strainer, without hole (for use with automatic waste)
	8669 011	Steel Space plug with silicone strainer, with hole (for use with manual waste)

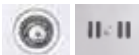
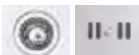

3 1/2" Waste fittings

	Ref.	Description
	8403 000	Basket waste fitting without overflow
	8403 003	Satin basket waste fitting without overflow
	8403 303	Basket waste fitting with perimetric overflow
	8403 310	Basket waste fitting with perimetric overflow 3,5" Gun Metal
	8403 312	Basket waste fitting with perimetric overflow 3,5" Copper
	8403 311	Basket waste fitting with perimetric overflow 3,5" Gold
	8403 300	Basket waste fitting with overflow
	8407 200	Waste fitting for Uragno sink (overflow with flexible pipe)

3 1/2" LIRA waste fittings

	Ref.	Description
	8403 001	LIRA Basket waste fitting without overflow
	8403 301	LIRA Basket waste fitting with overflow

2" Waste fittings

	Ref.	Description
	8401 000	2" waste fitting with overflow and rubber plug
	8402 000	One 2" waste fitting with overflow and one 2" waste fitting without overflow





1 1/4" Waste fitting

	Ref.	Description
	8404 000	Overflow fitting 1 1/4" for drainer



7" Waste fitting

	Ref.	Description
	8403 309	7" waste fitting with overflow and st. steel basket

Siphon

	Ref.	Description
	8410 000	One way siphon with dishwasher socket
	8415 000	Two ways siphon with dishwasher socket
	8435 000	Two way "Spazio" siphon with dishwasher socket
	8433 000	Three way "Spazio" siphon with dishwasher socket

LIRA Siphon

	Ref.	Description
	8435 001	LIRA* one way "Spazio" siphon with dishwasher socket
	8435 002	LIRA* two way "Spazio" siphon with dishwasher socket
	8435 003	LIRA* inspectable one way siphon with dishwasher socket

* we recommend combining LIRA siphons and waste fittings

Floor type siphons

Ref.	Description
8411 000	One way floor type siphon with dishwasher socket
8416 000	Two way floor type siphon with dishwasher socket

Various

Ref.	Description
8669 000	2" rubber plug
8669 001	Strainer plug for 3 1/2" waste fitting
8669 002	Strainer plug for 3 1/2" automatic waste fitting
8669 003	Strainer plug for Premium 3 1/2" waste fitting
8669 004	Strainer plug for Premium 3 1/2" automatic waste fitting
8155 000	Steel-clad plug 18/10 for waste bins Ref. 8113-8123
8118 006	Connecting pipe - (black) for waste disposal unit Ref. 8113-8123
8700 007	Silicone gasket for inset sinks (4 and 8 mm)
8700 062	Silicone gasket for flat-edge and flush-mount inset sinks
8700 080	Fixing brackets adapter kit (18) to be used for worktops 20 mm *
8669 009	Short-type cover kit for perimetral overflow
8669 008	Long-type cover kit for perimetral overflow
8401 001	Extension pipe for connection waste/overflow

Complements

Waste-disposer unit



Power	Ref.
380 W	8439 112

Foster waste disposers can be installed in all our sinks with 3.5" waste fitting. Remember to check the dimensions of the sink-waste shredder assembly. Waste disposers' compatibility with sinks of other manufacturers is not guaranteed.

accessories:
8439 043

Waste fitting for installation on marble/synthetic sinks

Pneumatic control

The waste disposer unit includes a practical pneumatic control. It can be installed on the worktop or on the sink.

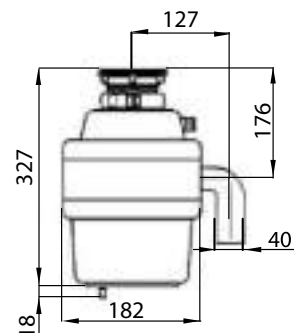
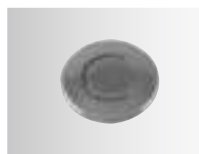

Radio control for food waste disposers



Ref.
8439 901

The remote control allows easy activation of the food waste disposer even when a switch-controlled outlet is not available.

Waste bins



Ref.
8113 800

Patty one-way

One-way waste-basket with access from the worktop (content 20 litres). Lid and paneling in stainless-steel.



tot. 20 lt min 40 cm

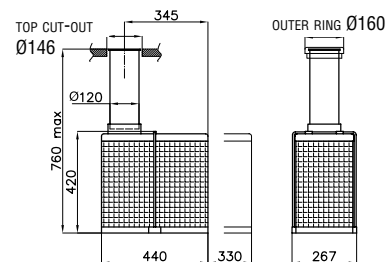

Ref.
8119 000

Patty top

Waste-basket with access from the worktop; top-end extractable bag with stainless-steel cover (content 13 litres)



tot. 13 lt min 30 cm

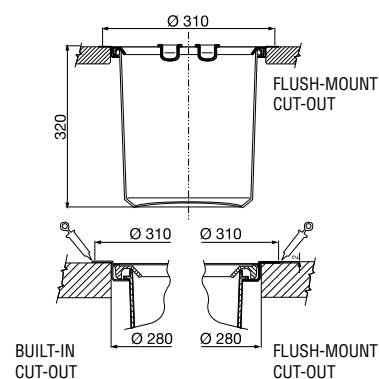

Complements

Waste bins



Ref. | |
8141 000

Smart
Extractable waste bin 16 litres
Minimum cabinet: 30 cm
Outer casing in stainless steel
Automatic lifting of the lid

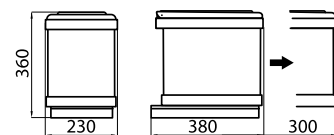

 tot. 16 lt  min 30 cm 



Ref. | |
8142 000

Smart 2
Waste bins System for waste separation
two extractable compartments 16 + 16 litres
Minimum cabinet: 40 cm
(45 cm for automatic opening)
Outer casing in stainless steel
Stainless steel cover usable
as support for accessories

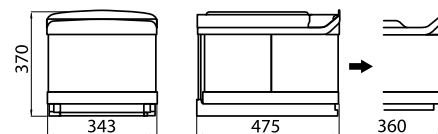



 tot. 32 lt  min 40 cm 

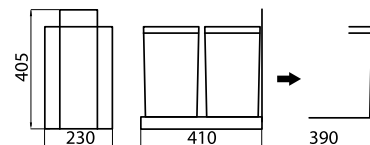

Ref. | |
8143 000

Split 2
Waste bins System for waste separation
two extractable compartments 12 + 12 litres
Minimum cabinet: 30 cm
Colored lids for easy
compartments recognition



 tot. 24 lt  min 30 cm



Ref. | |
8144 000

Split 4
Waste bins System for waste separation
with four bins 15 + 15 + 6 + 6 litres
For covered cabinets 60 and 90 cm
Modular compartments, colored lids
for easy compartments recognition

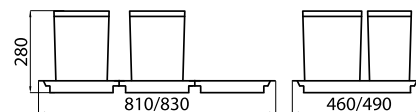

 tot. 42 lt  min 60 cm



Ref. | |
8145 000

Split 4 XL
Waste bins System for waste separation
with four bin 35 + 35 + 7,5 + 7,5 litres
For cabinets 60 cm
Full extension slides with soft closing
Fixed metal cover, that become
a practical shelf

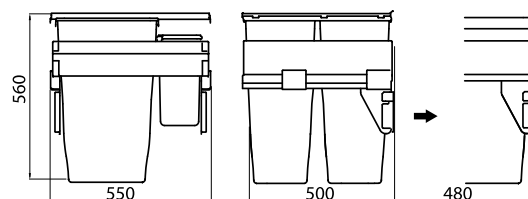

 tot. 85 lt  min 60 cm



Complements

Socket-holder towers



Ref. |
8000 011 |

Totem4 inox
Extractable socket-holder tower
- 2 Schuko sockets
- 1 ITA 3 poles 10A-16A socket
- 1 USB port for charging
Power cable supplied
With brushed stainless steel cap

Cutout: $\varnothing 102$ mm
Top thickness: max 50 mm

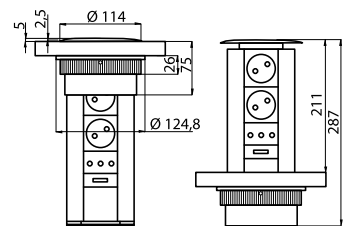

Ref. |
8000 012 |

Totem3
Extractable socket-holder tower
- 2 Schuko sockets
- 1 ITA 3 poles 10A-16A socket
Power cable supplied
With gray varnished cap

Cutout: $\varnothing 102$ mm
Top thickness: max 50 mm

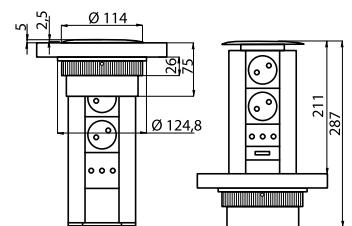

NEW

Ref. |
8000 014 |

Casper
Extractable socket-holder tower
- 2 Schuko sockets
Power cable supplied

Cutout: $\varnothing 80$ mm
Top thickness: max 60 mm

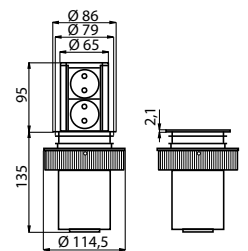

Ref. |
8000 214 |

Kit for suspended installation



Complements NEW

Built-in socket-holders



Ref.
8000 010
foster
brushed
finish

8000 110
Nebel*
finish

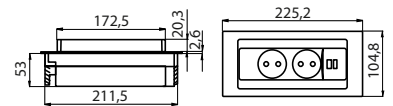

Reverse
Stainless steel push-push
built-in socket-holder
- 2 Schuko sockets
- 1 USB port for charging

Cutout: 215x88 mm

* Nebel is a particular finish, similar to a sandblasting, available for stainless steel worktops made to measure.



Ref.
8000 113

Filo3
Push-push built-in socket-holder slot
- 2 Schuko sockets
- 1 ITA 3 poles 10A-16A socket
Power cable supplied

Cutout: 195x157 mm
Worktop max thickness: 40 mm
(See the user manual for thickness more than 40 mm and for flush installation)

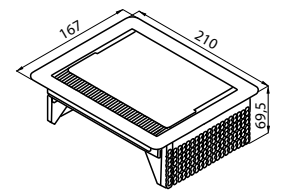

Available from July 2017



Ref.
8000 115

Cip
Built-in socket-holder slot
- 1 Schuko socket
Power cable supplied

Cutout: Ø 56 mm

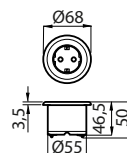

Accessories:





























- 8000 215 white cover kit
- 8000 115 still finish cover kit
- 8000 315 black cover kit

















Mixer Taps

The wide range of Foster mixer taps completes the washing area according to the sinks stainless steel finish and style.



- | | | | |
|---|--|---|--|
| Q Circle Colour p. 95  | Camillo p. 97  | Luisa p. 101  | Elettra p. 104  |
| Q Circle Plus p. 95  | Geo p. 97  | GF p. 101  | S1000 - Z66 p. 104  |
| Q Circle p. 95  | 1/2 Circle p. 97  | Omega Plus p. 101  | S1000 - Z65 p. 105  |
| GK p. 95  | Spring p. 97  | Omega Plus Gun Metal p. 101  | S1000 - Z85 p. 105  |
| Tube p. 96  | Flexo p. 98  | Omega p. 102  | Bite p. 105  |
| Play p. 96  | Hook p. 98  | Omega Gun Metal p. 102  | S1000 - RO p. 105  |
| Magnum p. 96  | Tre alto p. 98  | Omega Gold p. 102  | Dispenser p. 106  |

- | | |
|--|---|
| Master p. 98  | Omega Copper p. 102  |
| Flat p. 99  | Delta p. 103  |
| Arsenio p. 99  | Delta Plus p. 103  |
| KE p. 99  | KS p. 103  |
| Gamma 3 vie p. 100  | F2000 alto p. 103  |
| Gamma p. 100  | F2000 basso p. 104  |
| NYC p. 100  | Beta p. 104  |
| Lorenzo p. 100  | |

Special solutions



Q Circle Colour is an innovative mixer tap, **sporting an illuminated water flow, which changes colour according to the temperature:** blue for cold water, red for hot water, violet if mixed. No electrical connection is required, being the water itself that, flowing through two small turbines, powers the illumination LED. The visual temperature control avoids useless water waste and the hazard of being burned by hot water. The system is enclosed in a small box (16x12x8 cm) easily tucked away in the under-sink cabinet.



Arsenio and **Flat** are two **ideal "under-window" solutions.** The barrel can be easily lowered to reduce the height of the tap to just a few centimetres.



Magnum mixer tap is ideally **suited for a professional use.** The flexible hose makes it possible to reach every corner of the sink and the lever positioned directly on the shower makes it extra-easy to control the water flow.



GK and **Play** offer a particular appealing aesthetic with their big arch. **The mixer shower can be tilted** and the waterflow directed where needed.



The **Gamma 3 Vie** mixer tap allows the distribution of cold/hot water and filtered water for alimentary use. This function is possible thanks to a third independent pipe that can be connected to any water-conditioning system.



NEW

A whole new look for the **Omega** mixer taps, thanks to the physical PVD treatment (Physical Vapor Deposition). This technology uses precious metals to colour the steel surface and improves the resistance to scratches and wear and tear. The **Gun Metal, Gold** and **Copper** mixers are the natural complement of the KE bowls of the same colour.





Features

Foster offers a complete and varied collection of mixer taps both for their aesthetics and functional characteristics, and able to give added value to the wide range of sinks. The essential and modern design of squared proposals are alternative to more traditional models with soft and sinuous aesthetic. The remote controls and dispensers (see Sink Accessories section), reproduce perfectly the design of mixer taps, creating sets of high aesthetic value.

Quality materials

Foster mixer taps meet the strictest regulations. Certified materials with very low lead content and flexible ceramic cartridges tested at very high pressures provide high sturdiness, an always smooth and precise working and, most of all, full safety.



Inox AISI 316

Made in AISI 316 stainless steel, which guarantee a perfect resistance to corrosion and maximum hygiene and safety, even for food use water.



Double water flow

Several models are equipped with a switch to easily change the flow from continuous to shower.



Tap rotation

All the taps have a wide angle of rotation. Some models even permit a full 360° rotation.

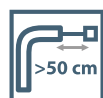

Extractable shower head

The head of the tap is extractable, in order to easily reach any area of the sink.



Strengthening plate

Foster's mixer taps are equipped with the strengthening plate that offers perfect stability on any sink.

Mixer Taps



Q Circle Colour

Single-lever mixer tap with rotating barrel and temperature-controlled LED illuminated water-flow.

Ref. _____
 8469 040
 chromed

strengthening plate is included
 hole for tap's building-in: \varnothing 35 mm
 built-in base: 55x46 mm
 rotating angle: 90°
 ceramic disc cartridge
 max worktop thickness: 40 mm
 rear encumbrance
 of control leverage: 50 mm

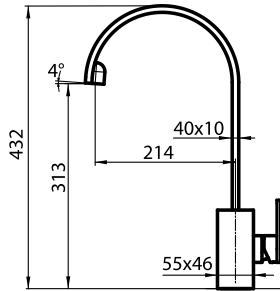

Q Circle Plus

Single lever mixer tap with rotating barrel and extractable barrel.

Ref. _____
 8469 020
 chromed

strengthening plate is included
 hole for tap's building-in: \varnothing 35 mm
 built-in base: 55x46 mm
 rotating angle: 90°
 ceramic disc cartridge
 max worktop thickness: 40 mm
 rear encumbrance
 of control leverage: 50 mm

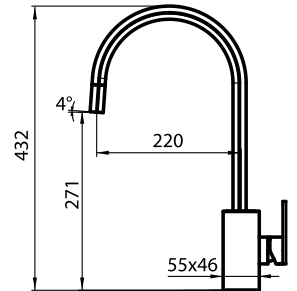

Q Circle

Single lever mixer tap with rotating barrel.

Ref. _____
 8469 000
 chromed

strengthening plate is included
 hole for tap's building-in: \varnothing 35 mm
 built-in base: 55x46 mm
 rotating angle: 90°
 ceramic disc cartridge
 max worktop thickness: 40 mm
 rear encumbrance of control leverage: 50 mm

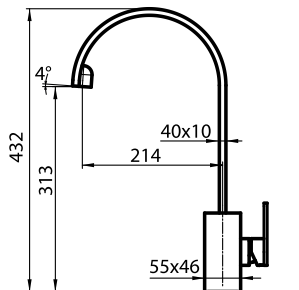

GK

Single lever faucet with rotating barrel and flexible head.

Ref. _____
 8488 000
 chromed

WARNING:
 The Cabinet of the GK tap has an irregular form.
 Please check the footprint
 strengthening plate is included
 hole for tap's building-in: \varnothing 35 mm
 built-in base: 62x46 mm
 rotating angle: 360°
 ceramic disc cartridge
 max worktop thickness: 40 mm

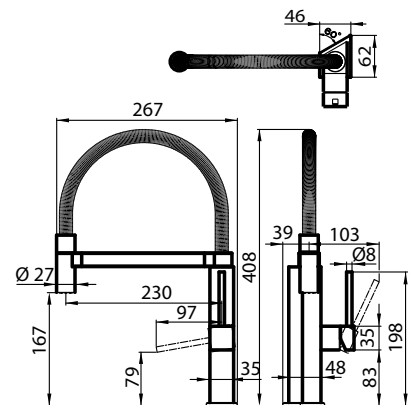

Mixer Taps



AISI 316



Tube

Single lever mixer tap with rotating barrel and flexible shower. **AISI 316 stainless steel.**

Ref. | |

8477 100
satin finish/
black

strengthening plate is included
hole for tap's building-in: \varnothing 35 mm
built-in base: \varnothing 55 mm
rotating angle: 360°
ceramic disc cartridge
max worktop thickness: 40 mm
rear encumbrance of control leverage: 25 mm

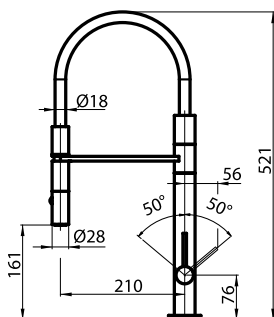

Play

Single lever mixer tap with rotating and flexible barrel.

Ref. | |

8487 000
chromed

strengthening plate is included
hole for tap's building-in: \varnothing 35 mm
built-in base: \varnothing 50 mm
rotating angle: 360°
ceramic disc cartridge
max worktop thickness: 40 mm
rear encumbrance of control leverage: 40 mm

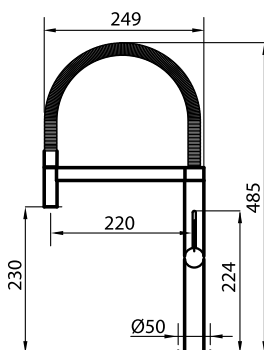

Magnum

Single lever mixer tap with rotating barrel and movable shower.

Ref. | |

8484 000
chromed

strengthening plate is included
hole for tap's building-in: \varnothing 35 mm
built-in base: \varnothing 50 mm
rotating angle: 360°
ceramic disc cartridge
max worktop thickness: 50 mm
rear encumbrance of control leverage: 50 mm

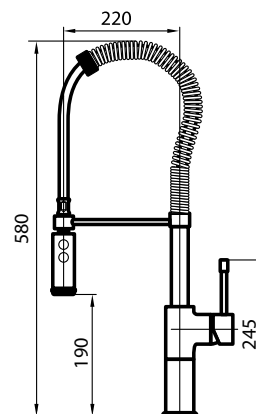

Mixer Taps



Camillo

Single lever mixer tap with rotating barrel and extractable shower head.

Ref.	
8467 000	chromed
8467 100	satin finish

strengthening plate is included
 hole for tap's building-in: \varnothing 35 mm
 built-in base: \varnothing 48 mm
 rotating angle: 170°
 ceramic disc cartridge
 max worktop thickness: 40 mm

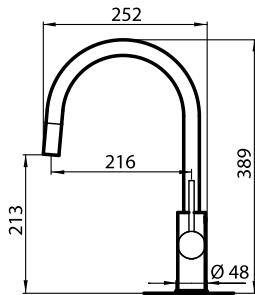

Geo

Single lever mixer tap with rotating barrel.

Ref.	
8454 000	chromed

strengthening plate is included
 hole for tap's building-in: \varnothing 35 mm
 built-in base: \varnothing 55 mm
 rotating angle: 360°
 ceramic disc cartridge
 max worktop thickness: 40 mm

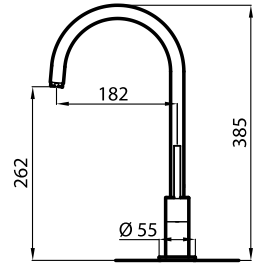

1/2 Circle

Single lever mixer tap with rotating barrel. **New version with aerator.**

Ref.	
8480 000	chromed

strengthening plate is included
 hole for tap's building-in: \varnothing 35 mm
 built-in base: \varnothing 50 mm
 rotating angle: 360°
 ceramic disc cartridge
 max worktop thickness: 40 mm
 rear encumbrance of control leverage: 40 mm

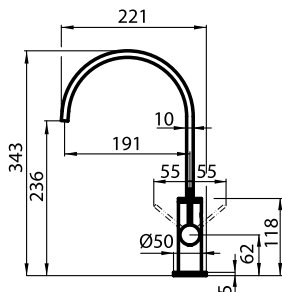

Spring

Single lever mixer tap with rotating barrel and extractable shower head.

Ref.	
8472 000	chromed

strengthening plate is included
 hole for tap's building-in: \varnothing 35 mm
 built-in base: \varnothing 45 mm
 rotating angle: 140°
 ceramic disc cartridge
 max worktop thickness: 55 mm
 rear encumbrance of control leverage: 80 mm

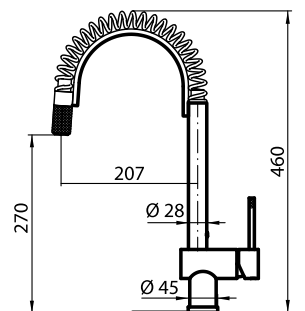

Mixer Taps



Flexo

Single lever mixer tap with rotating barrel and flexible head.



Ref. |
8456 000
chromed

strengthening plate is included
hole for tap's building-in: \varnothing 35 mm
built-in base: \varnothing 51 mm
rotating angle: 360°
ceramic disc cartridge
max worktop thickness: 40 mm

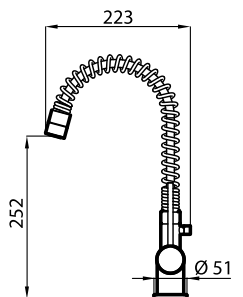

Hook

Single lever mixer tap with rotating barrel. **AISI 316** stainless steel.



Ref. |
8479 100
satin finish

strengthening plate is included
hole for tap's building-in: \varnothing 35 mm
built-in base: \varnothing 45 mm
rotating angle: 360°
ceramic disc cartridge
max worktop thickness: 40 mm
rear encumbrance of control leverage: 15 mm

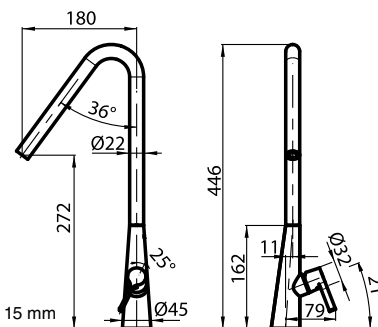

Tre alto

Single lever mixer tap with rotating barrel.



Ref. |
8468 000
chromed

strengthening plate is included
hole for tap's building-in: \varnothing 35 mm
built-in base: \varnothing 52 mm
rotating angle: 120°
ceramic disc cartridge
max worktop thickness: 40 mm

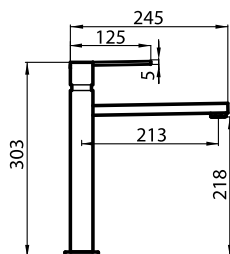

Master

Single lever mixer tap with rotating barrel.



Ref. |
8493 000
chromed

strengthening plate is included
hole for tap's building-in: \varnothing 35 mm
built-in base: 48x48 mm
rotating angle: 360°
ceramic disc cartridge
max worktop thickness: 40 mm

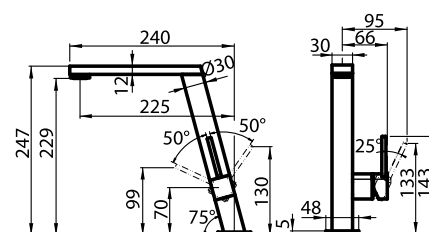

Mixer Taps



Gamma 3 vie

Three-way mixer tap with dual control and rotating barrel. The three-way system allows supply of hot/cold water and filtered water for alimentary use.

AISI 316

360°



Ref.

8496 100
satin finish

Mixer tap in AISI316 stainless steel, satin finish

strengthening plate is included
hole for tap's building-in: \varnothing 35 mm
built-in base: \varnothing 50 mm
rotating angle: 360°
ceramic disc cartridge
max worktop thickness: 50 mm

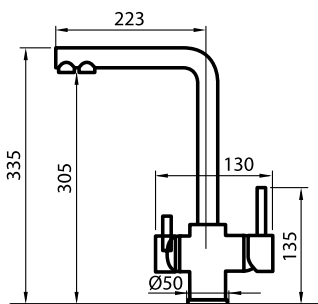

Gamma

Single lever mixer tap with rotating barrel and extractable shower head.

>50 cm

180°



Ref.

8483 001
chromed

strengthening plate is included
hole for tap's building-in: \varnothing 35 mm
built-in base: \varnothing 50 mm
rotating angle: 180°
ceramic disc cartridge
max worktop thickness: 30 mm

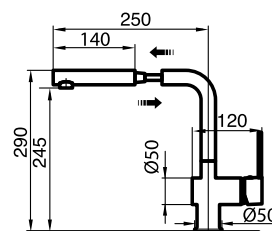

NYC

Single lever mixer tap with rotating barrel.

360°



Ref.

8486 000
chromed

strengthening plate is included
hole for tap's building-in: \varnothing 35 mm
built-in base: \varnothing 50 mm
rotating angle: 360°
ceramic disc cartridge
max worktop thickness: 40 mm
rear encumbrance of control leverage: 40 mm

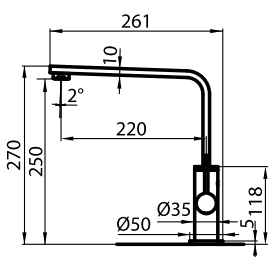

Lorenzo

Single lever mixer tap with rotating barrel and extractable shower head.

>50 cm

120°



Ref.

8466 000
chromed

8466 100
satin finish

strengthening plate is included
hole for tap's building-in: \varnothing 35 mm
built-in base: \varnothing 48 mm
rotating angle: 120°
ceramic disc cartridge
max worktop thickness: 40 mm

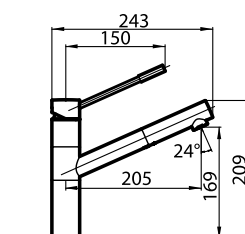

Mixer Taps



Luisa

Single lever mixer tap with rotating barrel and extractable shower head.

Ref.	
8482 000	
chromed	

strengthening plate is included
 hole for tap's building-in: \varnothing 35 mm
 built-in base: \varnothing 50 mm
 rotating angle: 360°
 ceramic disc cartridge
 max worktop thickness: 40 mm
 rear encumbrance of control leverage: 50 mm

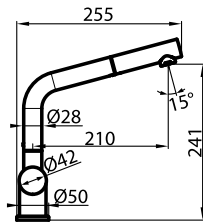

GF

Single lever mixer tap with rotating barrel.

Ref.	
8452 000	
chromed	

strengthening plate is included
 hole for tap's building-in: \varnothing 35 mm
 built-in base: \varnothing 53 mm
 rotating angle: 360°
 ceramic disc cartridge
 max worktop thickness: 30 mm

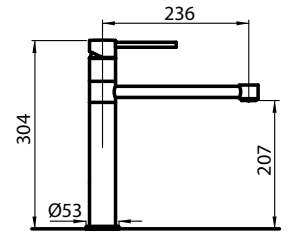

Omega plus

Miscelatore monocomando con canna girevole e bocca estraibile.

Sigla	
8497 020	
cromato	

strengthening plate is included
 hole for tap's building-in: \varnothing 35 mm
 built-in base: \varnothing 50 mm
 rotating angle: 360°
 ceramic disc cartridge
 max worktop thickness: 40 mm
 rear encumbrance of control leverage: 35 mm

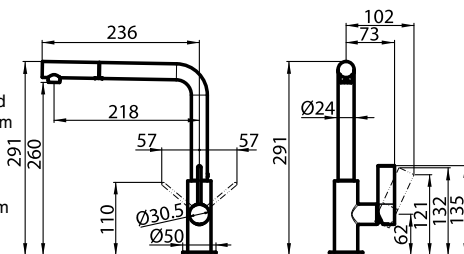

Omega plus Gun metal

Single lever mixer tap with rotating barrel and extractable shower head.

Ref.	
8498 856	
gun metal	

strengthening plate is included
 hole for tap's building-in: \varnothing 35 mm
 built-in base: \varnothing 50 mm
 rotating angle: 360°
 ceramic disc cartridge
 max worktop thickness: 40 mm
 rear encumbrance of control leverage: 35 mm

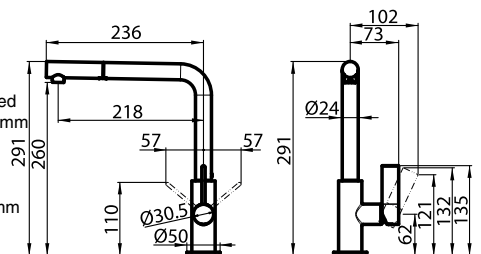

Mixer Taps



Omega

Single lever mixer tap with rotating barrel.

Ref. |
8497 000
chromed

strengthening plate is included
hole for tap's building-in: \varnothing 35 mm
built-in base: \varnothing 50 mm
rotating angle: 360°
ceramic disc cartridge
max worktop thickness: 40 mm
rear encumbrance
of control leverage: 35 mm

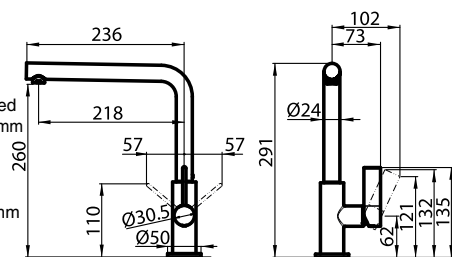

Omega Gun Metal

Single lever mixer tap with rotating barrel.

Ref. |
8497 856
gun metal

strengthening plate is included
hole for tap's building-in: \varnothing 35 mm
built-in base: \varnothing 50 mm
rotating angle: 360°
ceramic disc cartridge
max worktop thickness: 40 mm
rear encumbrance
of control leverage: 35 mm

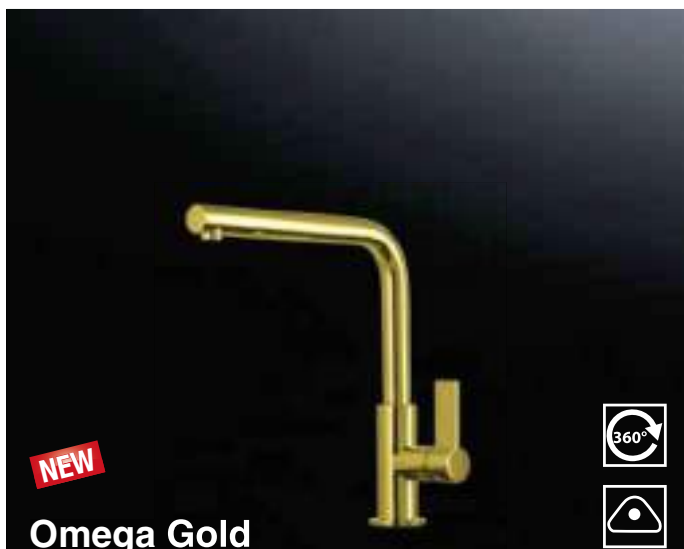
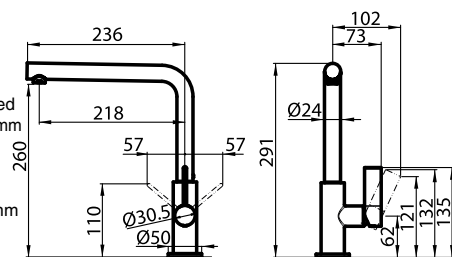

Omega Gold

Single lever mixer tap with rotating barrel.

Ref. |
8497 700
gun metal

strengthening plate is included
hole for tap's building-in: \varnothing 35 mm
built-in base: \varnothing 50 mm
rotating angle: 360°
ceramic disc cartridge
max worktop thickness: 40 mm
rear encumbrance
of control leverage: 35 mm

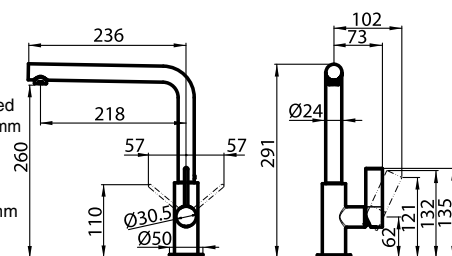

Omega Copper

Single lever mixer tap with rotating barrel.

Ref. |
8497 400
copper

strengthening plate is included
hole for tap's building-in: \varnothing 35 mm
built-in base: \varnothing 50 mm
rotating angle: 360°
ceramic disc cartridge
max worktop thickness: 40 mm
rear encumbrance
of control leverage: 35 mm

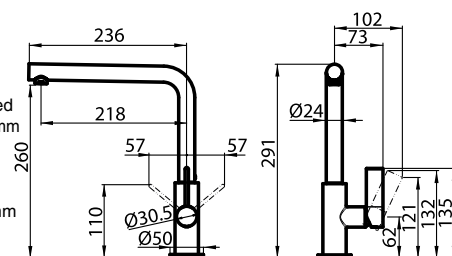

Mixer Taps



Delta

Single lever mixer tap with rotating barrel.

Ref. |
8441 000
chromed

strengthening plate is included
hole for tap's building-in: \varnothing 35 mm
built-in base: \varnothing 50 mm
rotating angle: 360°
ceramic disc cartridge
max worktop thickness: 40 mm

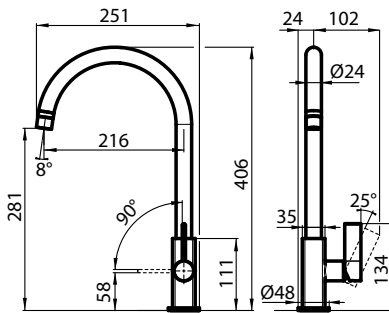

Delta Plus

Single lever mixer tap with rotating barrel and extractable shower head.

Ref. |
8441 030
chromed

strengthening plate is included
hole for tap's building-in: \varnothing 35 mm
built-in base: \varnothing 50 mm
rotating angle: 360°
ceramic disc cartridge
max worktop thickness: 40 mm

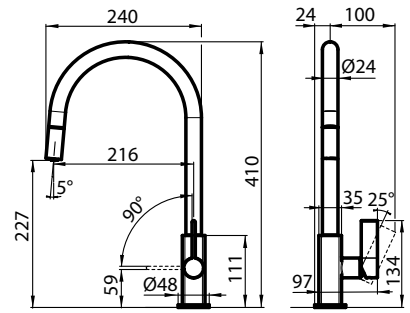

KS

Single lever mixer tap with rotating barrel.

Ref. |
8485 000
chromed

strengthening plate is included
hole for tap's building-in: \varnothing 35 mm
built-in base: \varnothing 50 mm
rotating angle: 360°
ceramic disc cartridge
max worktop thickness: 50 mm

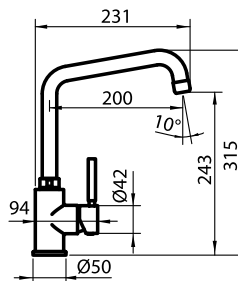

F2000 - Alto

Single lever mixer tap with rotating barrel.

Ref. |
8458 000
chromed

strengthening plate is included
hole for tap's building-in: \varnothing 35 mm
built-in base: \varnothing 50 mm
rotating angle: 360°
ceramic disc cartridge
max worktop thickness: 55 mm
rear encumbrance of control leverage: 60 mm

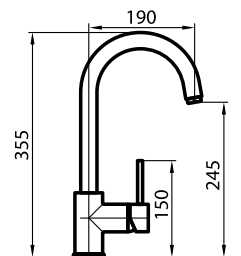

Mixer Taps



F2000 - Basso

Single lever mixer tap with rotating barrel and extractable shower.

Ref.	
8459 000	
chromed	

strengthening plate is included
 hole for tap's building-in: \varnothing 35 mm
 built-in base: \varnothing 60 mm
 rotating angle: 180°
 ceramic disc cartridge
 max worktop thickness: 50 mm

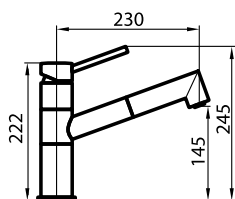

Beta

Single lever mixer tap with rotating barrel.

Ref.	
8490 000	
chromed	

strengthening plate is included
 hole for tap's building-in: \varnothing 35 mm
 built-in base: \varnothing 50 mm
 rotating angle: 360°
 ceramic disc cartridge
 max worktop thickness: 40 mm

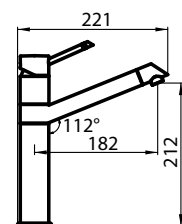

Elettra

Single lever mixer tap with rotating barrel.

Ref.	
8476 000	
chromed	

strengthening plate is included
 hole for tap's building-in: \varnothing 35 mm
 built-in base: \varnothing 58 mm
 rotating angle: 360°
 ceramic disc cartridge
 max worktop thickness: 55 mm

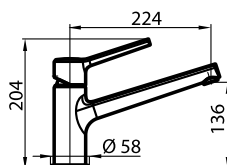

S1000 - Z66

Single lever mixer tap with rotating barrel and extractable shower.

Ref.	
8448 500	
chromed	

strengthening plate is included
 hole for tap's building-in: \varnothing 35 mm
 built-in base: \varnothing 55 mm
 rotating angle: 360°
 ceramic disc cartridge
 max worktop thickness: 55 mm
 rear encumbrance of control leverage: 60 mm

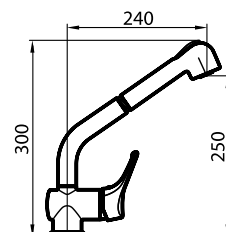

Mixer Taps



S1000 - Z65

Single lever mixer tap with rotating barrel and extractable shower.

Ref.	
8449 500	
chromed	

strengthening plate is included
 hole for tap's building-in: \varnothing 35 mm
 built-in base: \varnothing 55 mm
 rotating angle: 180°
 ceramic disc cartridge
 max worktop thickness: 45 mm

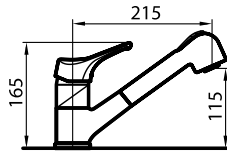

S1000 - Z85

Single lever mixer tap with rotating barrel.

Ref.	
8442 500	
chromed	

strengthening plate is included
 hole for tap's building-in: \varnothing 35 mm
 built-in base: \varnothing 48 mm
 rotating angle: 360°
 ceramic disc cartridge
 max worktop thickness: 55 mm

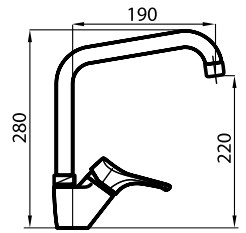

Bite

Single lever mixer tap with rotating barrel.

Ref.	
8481 000	
chromed	

strengthening plate is included
 hole for tap's building-in: \varnothing 35 mm
 built-in base: \varnothing 54 mm
 rotating angle: 360°
 ceramic disc cartridge
 max worktop thickness: 40 mm
 rear encumbrance
 of control leverage: 15 mm

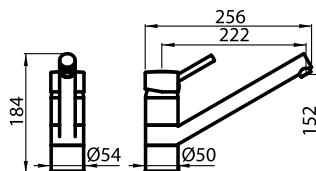

S1000 - RO

Single lever mixer tap with rotating barrel.

Ref.	
8443 002	
chromed	

strengthening plate is included
 hole for tap's building-in: \varnothing 35 mm
 built-in base: \varnothing 50 mm
 rotating angle: 360°
 ceramic disc cartridge
 max worktop thickness: 55 mm

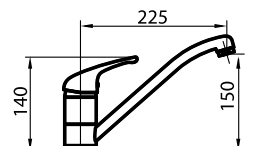



Dispenser



Quadra Dispenser
Chromed metal built-in liquid soap/detergent dispenser

Ref.
8520 000

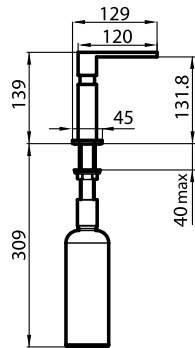

Round Dispenser
Chromed steel built-in liquid soap/detergent dispenser

Ref.
8530 000

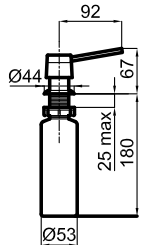

Evo Dispenser
Built-in liquid soap/detergent dispenser

Ref.
8520 010
chromed

8520 100
satin finish

NEW

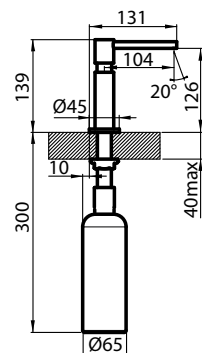

Evo Gun metal Dispenser
Built-in liquid soap/detergent dispenser

Ref.
8520 856
gun metal

NEW

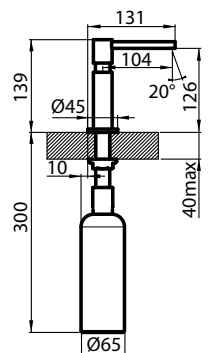



Dishwashers

High performance with respect for the environment

Low consumption of energy and water, respect for the quality of home life and high performance. These are the values of the new Foster dishwashers. An easy but complete range of solutions for every space and washing need, that reach the **A+++** class, complying to new European regulations.

Features

P Programs: in the Foster range you can choose freely between sets of practical and essential programs or a complete sophisticated programming suited for every individual need.

Acquastop: stops the water supply and prevents leaks and overflows at source. It is a standard equipment on all models.

Adjustable basket: the upper basket is simple to adjust in height, even when fully loaded. This allows better space management according to washing needs.

Water saving: Foster pays particular attention to a valuable resource such as water. The icon appears next to models with a consumption of less than 10 liters per cycle.

1/2 Half Load: saving time and energy with the half-load setting. Available on all programs.

Delayed programming: It is possible to program a delayed start of the dishwasher, and thus to optimize the energy consumption during the day.

Tabs "All in 1": this option guarantees perfect results with all kinds of detergent. Once it is activated, the washing cycle is adapted to the practical "all in 1" Tabs instead of the regular detergent.

16 Capacity: thanks to a careful design Foster dishwashers are very spacious, up to 16 place-setting capacity.

Dishwashers

Foster Milano **NEW**

Ref.

fully built-in dishwasher 2930 000



Available from September 2017

Energy class A+++
 Washing efficiency: A
 Drying efficiency: A
Place-setting capacity 16
 45 dB(A) sound power
 Electronic programming
 Digital panel
 5 washing programs (5 of which are rapid cycles): automatic, intensive, eco, rinsing, extra-rapid 20 min.
Third level for cutlery
 Adjustable central basket (3-position button)

Acquastop safety system
 Automatic door opening - Perfect Dry
 Half Load Option
 24 hour delayed programming
 Low salt-rinsing agent indicators
 Setting for all-purpose detergents (3 in 1 button)
 End of cycle warning light
 Panel connection – door with slider system
 Hinges with variable fulcrum
 Frontal adjustment of rear feet 0-50 mm

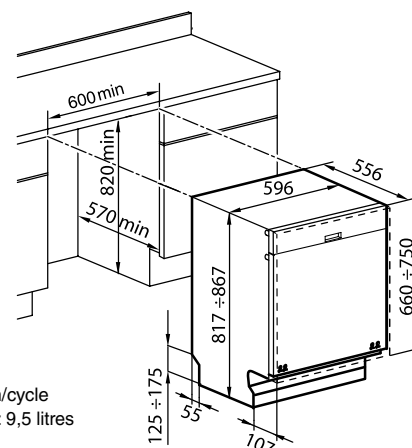

Technical data
 voltage rating:
 220-240 V - 50Hz
 energy consumption 0,86 kwh/cycle
 water consumption per cycle: 9,5 litres

Door panel dimension limits:
 thickness 18-20 mm
 height 660-750 mm



Special features:



Extra rapid - when you're in a hurry, this function reduces the programs' duration, down to the 15' of the rapid program.



Perfect Dry - the drying cycle is improved by the automatic opening of the door at the cycle's end, so as to vent the residual steam.



Total hygiene - a program for those who have above-average needs in terms of hygiene; it increases the washing and drying temperatures.



The dishwasher has a water **cleanliness sensor** to optimize the washing time and water consumption.



Door panel with slider

The door panel can be up to 75 cm high, thanks to the connecting system equipped with slider, which slides it upwards when opening. This eliminates the need for a cut-out in the plinth.

Super capacity

The third basket and the specific shape of the combs make it possible to load up to 16 place-settings.

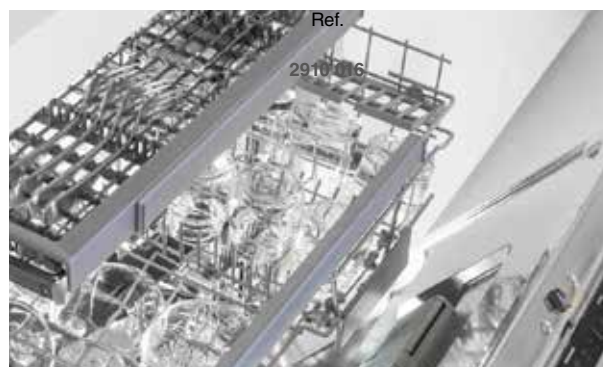
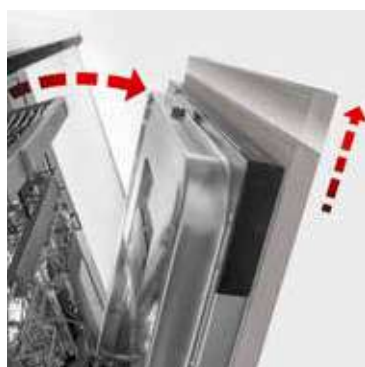

Dishwashers

FL NEW	Ref.
fully built-in dishwasher	2960 000



Energy class: A+++
 Washing efficiency: A
 Drying efficiency: A
Place-setting capacity: 13
 44 dB(A) sound power
 Electronic programming
 Digital panel
 10 washing programs (5 of which are rapid cycles): soaking: crystal, eco, quick, auto, baby-care, eco-rapid, delicate rapid, daily clean, intensive rapid
Third level for washing cutlery baskets
 Elevated lower basket
 Adjustable central basket (3-position button)

Automatic opening at the end of cycle
 Acquastop safety system
 Residual heat drying system
 Distributed Half Load Option
 24 hour delayed programming
 Sanitation program
 Low salt-rinsing agent indicators
 Setting for all-purpose detergents (3 in 1 button)
 End-of-cycle indicator:
 Acoustic + floor light
 Hinges with variable fulcrum
 Frontal adjustment of rear feet 0-70 mm

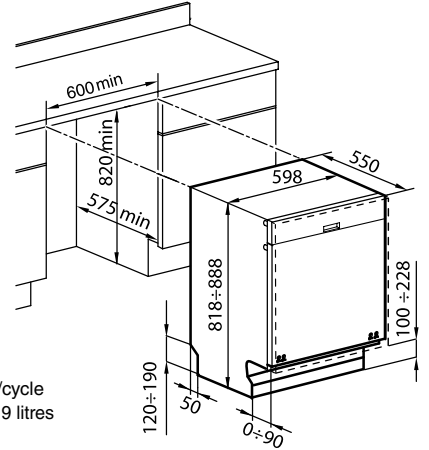

Technical data
 voltage rating:
 220-240 V - 50Hz
 energy consumption 0,81 kwh/cycle
 water consumption per cycle: 9 litres



Door panel dimension limits:
 thickness 18-20 mm
 height 660-720 mm

Accessories:

- A** Stainless steel door panel



Special features:

<p>A+++ The new FL dishwasher offers the best energy efficiency and water economy, with a need of only 9 litres per cycle.</p>	<p> The third upper basket, meant for cutlery, is extremely practical and increases the available space up to 13 place-settings.</p>	
<p>P10 As many as 10 programs (5 plus 5 rapid programs) make for an extremely flexible dishwasher, adapted for all kinds of need.</p>	<p> The FL dishwasher does its job in perfect silence: only 44 dB of noise make it barely audible while in operation.</p>	

accessories

Stainless steel door panel



Ref.	
A	2910 016
B	2910 003

finish: AISI 304 satin-finish
 size: 595x716x20 mm

The integrated handle is easy to couple with any kitchen door.
 Compatible with all the 60 cm dishwasher models.

Dishwashers

KS Plus

NEW

Ref.

fully built-in dishwasher 2941 000



Available from July 2017

Accessories: (page 109)

A Stainless steel door panel



Energy class A+

Washing efficiency: A
 Drying efficiency: A
 Place-setting capacity: 13
 44 dB(A) sound power
 Electronic programming
 Digital panel
 10 washing programs (5 of which are rapid cycles): soaking, crystal, eco, quick, auto, baby-care, eco-rapid, delicate rapid, daily clean, intensive rapid
 Elevated lower basket
 Adjustable central basket (3-position button)

Acquastop safety system
 Residual heat drying system
 Distributed Half Load Option
 24 hour delayed programming
 Sanitation program
 Low salt-rinsing agent indicators
 Setting for all-purpose detergents (3 in 1 button)
 End-of-cycle indicator:
 Acoustic + floor light
 Hinges with variable fulcrum
 Frontal adjustment of rear feet 0-70 mm

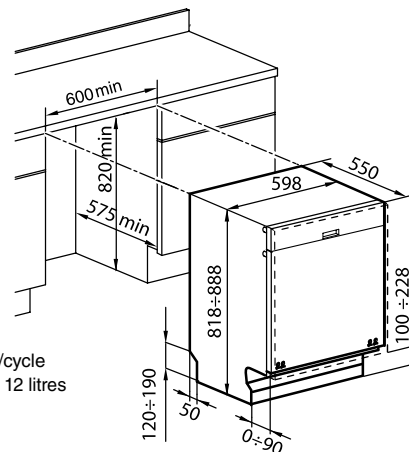

Technical data
 voltage rating:
 220-240 V - 50Hz
 energy consumption 1,01 kwh/cycle
 water consumption per cycle: 12 litres

Door panel dimension limits:
 thickness 18-20 mm
 height 660-720 mm

Elettra

Ref.

fully built-in dishwasher 2950 000



Accessories: (page 109)

B Stainless steel door panel



Energy class A+

Washing efficiency: A
 Drying efficiency: A
 Place-setting capacity 12
 49 dB (A) sound power as per EN 704-3
 Electronic programming
 Digital panel
 5 washing programs: intensive, eco, daily clean, quick, soaking
Half-load function for all programs
 Acquastop safety system

3-6-9 hour delayed programming
 Remaining wash time indication
 Setting for all-purpose detergents
 Low salt-rinsing agent indicators
 Upper basket adjustable in height at full load
 Adjustable cutlery basket
 Goblet support
 Frontal adjustment of rear feet
 Feet adjustment 0-50 mm

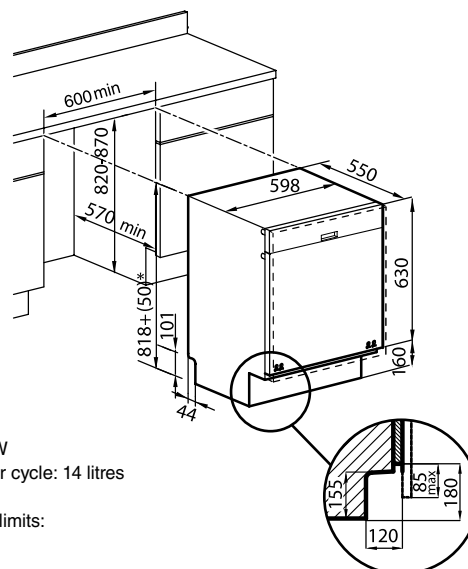

Technical data
 voltage rating:
 220-240 V - 50Hz
 total power: 2.000 W
 heating power: 1.800 W
 water consumption per cycle: 14 litres

Door panel dimension limits:
 thickness 16-24 mm
 height 630-715 mm



Gas cooker hobs

Design, technology and high-grade materials are the ingredients of a cooking range characterised by high functionality, professional performance and energy saving. Foster cooker hobs are offered in a wide range of built-in versions; moreover, the cooker hob can be incorporated into the custom-sized stainless steel worktop. Foster cooker hobs are made of AISI 304 stainless steel and come in a variety of finishes.

Foster Milano p. 117



FL p. 127



Professionale p. 136



RANGETOP
Foster Milano p. 118



KE p. 129



Veronika FM p. 137



GK p. 120



KE black p. 130



Veronika p. 138



S4000 p. 121



KE White p. 131



Elettra p. 139



S4000 Line XL p. 123



KE Line p. 132



Angolare p. 140



S4000 Line p. 124



KE Domino p. 133



Rondò p. 141



S4000 Domino p. 125



Marine p. 134

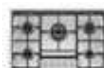

Quadra
Angolare p. 126



KS p. 135



High efficiency coupled with environmental awareness



High efficiency coupled with environmental awareness. Foster offers a broad and modern selection of cooker hobs that are tailored to various space-related needs and implement special technological features for guaranteed energy saving. The new cooker hobs feature high-efficiency burners that allow a gas saving from 20% to 25% when compared to traditional hobs.

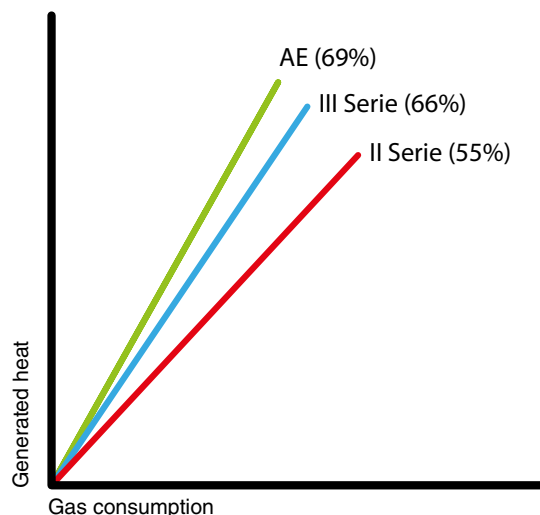

Burners



High Efficiency burners (AE):

5kW and 25% gas saving

Energy efficiency is a plus offered by the research of Foster. All the new products are studied to reduce gas consumption and respect the environment. Thanks to the new AE burners (which stands for "Alta Efficienza", i.e. high efficiency) cooker hobs have a maximum efficiency rate of 69% and the DUAL AE burner reaches a maximum power of 5 kW. The brass burner ring gives a professional look.



III^ serie burners: 20% gas saving

Ultra-new burners. A concentration of design, technology and performance. Their efficiency is vastly superior to the dictates of the European standards, with an even more extensive min/max power ratio for the utmost flexibility of use. The system that locks the cover and burner cap achieves perfect positioning and makes cleaning extremely practical.



Dual burners: from 300 to 4.500 W

Innovative and versatile burner, with triple crown ignited independently by a single knob. Power delivery from 300 to 4500 W.

Features

Safety in the kitchen

The ultra-rapid latest generation thermocouples make the burners even safer while the ignition time is reduced to the minimum.



Safe cooking

All Foster cooker hobs are equipped with safety valves. They shut off the gas supply very quickly if the flame accidentally goes out.



Under-knob ignition

The utmost freedom of movement with electronic under-knob ignition, a common feature of all models that allows a one-hand ignition of the burner. Power supply: 220-240 V 50-60 Hz.



Ultra-flat

Design meets functionality in the the ultra-flat models. Elegant grids that form a generously sized overall surface.

Grids

Almost all Foster hobs are equipped with cast-iron grids, an ideal material due to the manifold properties characterising it: high heat capacity that improves cooking performance; high weight and stability that improve safety; sturdiness that preserves the hob's original aspect over time; easy cleaning.

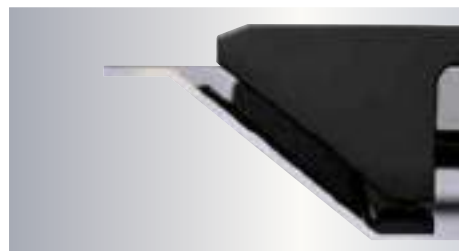

Pure elegance

The cone-shaped hobs raise up from the surface, evoking the power of fire. The grids surmount the burners, leaving the hobs surface "free".

Cast-iron grids

Almost all the Foster cooker hobs are equipped with cast-iron grids, a perfect material due to its many properties: high thermal capacity that improves the cooking efficiency; weight and stability that improve safety; sturdiness which keeps their look unaltered over time; easiness to clean.

Practicality

A deep and inclined containing area cradles the burners and cast-iron grids, which form a continuous workable surface. The inclination of the containing area's edge, makes it very easy to clean, also in corners.

Features

Built-in and beyond

The methods with which worktops can be built-in have become increasingly more varied and customized. Foster was the first sink manufacturer to have researched and used the new recessing methods and has thus acquired a great deal of experience. It now offers the most comprehensive range available on the market, with flush-mount and flat-edge installation.



Standard

Traditional built-in with the vertical, 8-mm edge.



Q4

The casing has a square edge that stands outside the work surface by just 4 mm.

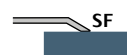

Flat-edge

An original edge, with an inclined, 3-mm high profile, matching an extreme elegance with the easiness of installation.



Flush-mount

The flush-mount cooker hobs have no vertical edge, and must be sunk into a 1,5 mm deep recess in the worktop's surface.



Built-in

Almost the whole range of Foster cooker hobs can be integrated into stainless steel worktops; it is the most elegant and professional solution, that creates a seamless work-surface.



Rangetop

The Foster Milano series is available, apart from the classic built-in version, also as Rangetop, which gives a more professional aspect to the cooking area. The Rangetop are elegant steel items that grant a sure visual impact whatever the concept and the materials featured in the kitchen area.

accessories

1



Wok support
9601 668

2



St. steel Wok Ø 36 cm
8173 000

3



Cast-iron grill 44x22 cm
8172 000

4



Wok support
9601 727

5



Pan support grid
8152 000

6



Cast-iron support 11x23 cm
9601 742

7



Cast-iron support
9601 741



Foster Milano **NEW**



Foster Milano NEW

FORMAL PURITY, PROFESSIONAL PERFORMANCE



 **High-Efficiency burners.**
Up to 25% energy saving

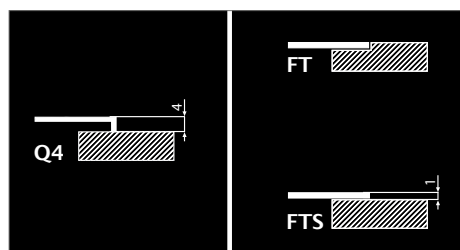

Flexible installation

The Foster Milano hobs are available with several types of edge: flush-mount (FT), top-mount in the elegant version with (Q4) edge, or also by installing the flush-mount version as top-mount (FTS).



XXL Grids

The weighty enamelled cast iron grid has extraordinary dimensions, 33x25 cm, with a working surface up to 50% bigger compared to a standard cooker hob.



Ultra-flat surface

The cast-iron grids form a seamless surface jutting just a few millimeters from the hob, on which one can move pots around with great ease and in perfect safety.



High efficiency burners

The AE burners guarantee up to 25% energy saving compared to standard burners. All models are designed with at least one wok Dual burner of 4.2 kW.



Cast iron wok support











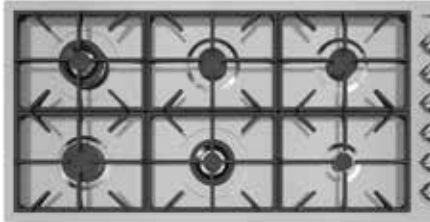



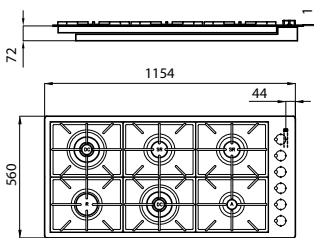

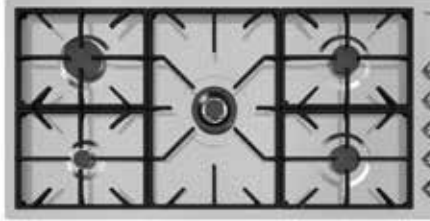



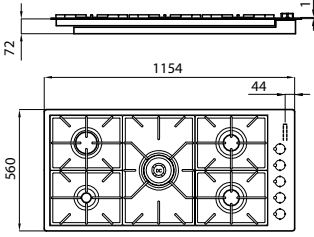





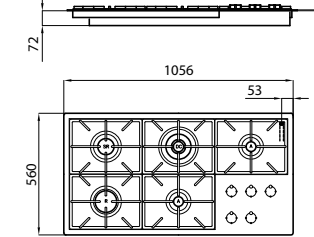

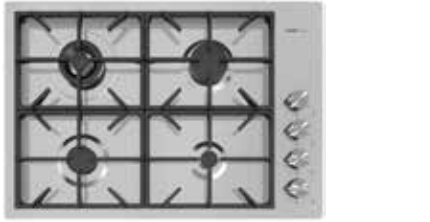

All the Foster Milano cooker hobs are equipped with a precious cast iron wok support, that allows the safe use of rounded pans.

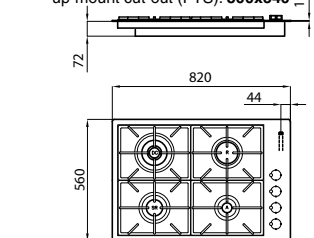

Foster Milano knob

The precious satin-finish metal knob, is the defining element of the entire series. It is present on the cooker hob, on the oven and even graces the tap area of the sink.

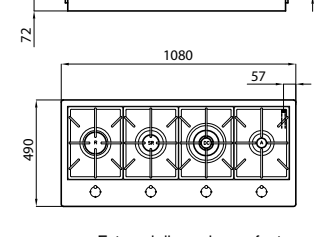
Foster Milano NEW

	Features	Version	Ref.	Technical Drawing
	<p>AISI 304 brushed Cast iron grids and enamelled burner covers Tot. power 15.900 W auxiliary: 1.000 W semi-rapid: 2x1.750 W</p>	<p>rapid: 3.000 W dual: 2x4.200 W Electric ignition Safety valves with ultra-rapid thermocouples</p>	<p> 7649 000</p> <hr/> <p> 7639 000</p> <hr/> <p> 7639 000</p>	<p>Q4: 1154x560 - cut-out: 1134x540 Flush-mount: 1154x560 - cut-out (FT): see web site up-mount cut-out (FTS): 1134x540</p>  <p>External dimensions refer to Flush-mount version</p>
Supplied with: 2x  (see page 114)				
	<p>AISI 304 brushed Cast iron grids and enamelled burner covers Tot. power 11.700 W auxiliary: 1.000 W semi-rapid: 2x1.750 W</p>	<p>rapid: 3.000 W dual: 4.200 W Electric ignition Safety valves with ultra-rapid thermocouples</p>	<p> 7646 000</p> <hr/> <p> 7636 000</p> <hr/> <p> 7636 000</p>	<p>Q4: 1154x560 - cut-out: 1134x540 Flush-mount: 1154x560 - cut-out (FT): see web site up-mount cut-out (FTS): 1134x540</p>  <p>External dimensions refer to Flush-mount version</p>
Supplied with:  (see page 114)				
	<p>AISI 304 brushed Cast iron grids and enamelled burner covers Tot. power 10.950 W auxiliary: 2x1.000 W semi-rapid: 1.750 W rapid: 3.000 W dual: 4.200 W Electric ignition Safety valves with ultra-rapid thermocouples</p>	<p> 7648 000</p> <hr/> <p> 7638 000</p> <hr/> <p> 7638 000</p>	<p>Q4: 1056x560 - cut-out: 1036x540 Flush-mount: 1056x560 - cut-out (FT): see web site up-mount cut-out (FTS): 1036x540</p>  <p>External dimensions refer to Flush-mount version</p>	
Supplied with:  (see page 114)				
	<p>AISI 304 brushed Cast iron grids and enamelled burner covers Tot. power 9.950 W auxiliary: 1.000 W semi-rapid: 1.750 W rapid: 3.000 W dual: 4.200 W Electric ignition Safety valves with ultra-rapid thermocouples</p>	<p> 7647 000</p> <hr/> <p> 7637 000</p> <hr/> <p> 7637 000</p>	<p>Q4: 820x560 - cut-out: 800x540 Flush-mount: 820x560 - cut-out (FT): see web site up-mount cut-out (FTS): 800x540</p>  <p>External dimensions refer to Flush-mount version</p>	
Supplied with:  (see page 114)				
	<p>AISI 304 brushed Cast iron grids and enamelled burner covers Tot. power 9.950 W auxiliary: 1.000 W semi-rapid: 1.750 W rapid: 3.000 W dual: 4.200 W Electric ignition Safety valves with ultra-rapid thermocouples</p>	<p> 7650 000</p> <hr/> <p> 7640 000</p> <hr/> <p> 7640 000</p>	<p>Q4: 1080x490 - cut-out: 1060x470 Flush-mount: 1080x490 - cut-out (FT): see web site up-mount cut-out (FTS): 1060x470</p>  <p>External dimensions refer to Flush-mount version</p>	
Supplied with:  (see page 114)				

RANGETOP Foster Milano NEW

AN OUT OF THE ORDINARY COOKING CENTER



 **High-Efficiency burners.**
Up to 25% energy saving

Ref.

Technical Drawing

Dimensions: 1200x650



3166 000

AISI 304 brushed
Cast iron grids and
enamelled burner covers
Tot. power 15.900 W
auxiliary: 1.000 W
semi-rapid: 2x1.750 W

rapid: 3.000 W
dual: 2x4.200 W
Electric ignition
Safety valves
with ultra-rapid
thermocouples

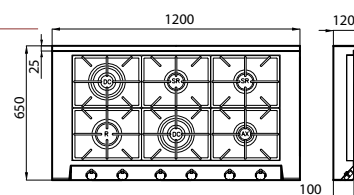

Supplied with: 2x **1** (see page 114)

Dimensions: 1200x650



3167 000

AISI 304 brushed
Cast iron grids and
enamelled burner covers
Tot. power 11.700 W
auxiliary: 1.000 W
semi-rapid: 2x1.750 W

rapid: 3.000 W
dual: 4.200 W
Electric ignition
Safety valves
with ultra-rapid
thermocouples

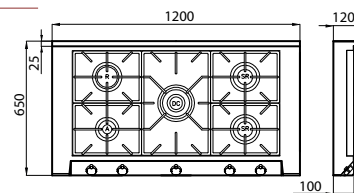

Supplied with: **1** (see page 114)

Professionale impact

The Foster Milano series is available, apart from the classic built-in version, also as Rangetop, which gives a more professional aspect to the cooking area.

The Rangetop cooker hobs are elegant steel items that grant a sure visual impact whatever the concept and the materials featured in the kitchen area.



RANGETOP Foster Milano NEW

Ref.

Technical Drawing

Dimensions: 900x650

3162 000



AISI 304 brushed
Cast iron grids and
enamelled burner covers
Tot. power 9.950 W
auxiliary: 1.000 W
semi-rapid: 1.750 W

rapid: 3.000 W
dual: 4.200 W
Electric ignition
Safety valves
with ultra-rapid
thermocouples

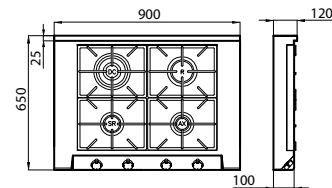

Supplied with: **1** (see page 114)

Dimensions: 1200x650

3154 000



AISI 304 brushed
Cast iron grids and
enamelled burner covers
Tot. power 9.950 W
auxiliary: 1.000 W
semi-rapid: 1.750 W

rapid: 3.000 W
dual: 4.200 W
Electric ignition
Safety valves
with ultra-rapid
thermocouples

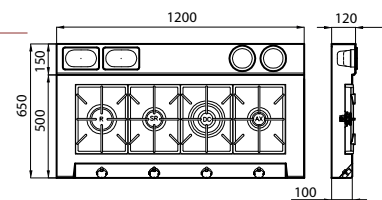

Supplied with: **1** (see page 114)

Dimensions: 1200x500

3164 000



AISI 304 brushed
Cast iron grids and
enamelled burner covers
Tot. power 9.950 W
auxiliary: 1.000 W
semi-rapid: 1.750 W

rapid: 3.000 W
dual: 4.200 W
Electric ignition
Safety valves
with ultra-rapid
thermocouples

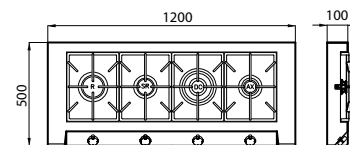

Supplied with: **1** (see page 114)

How to install Rangetops cooker hobs

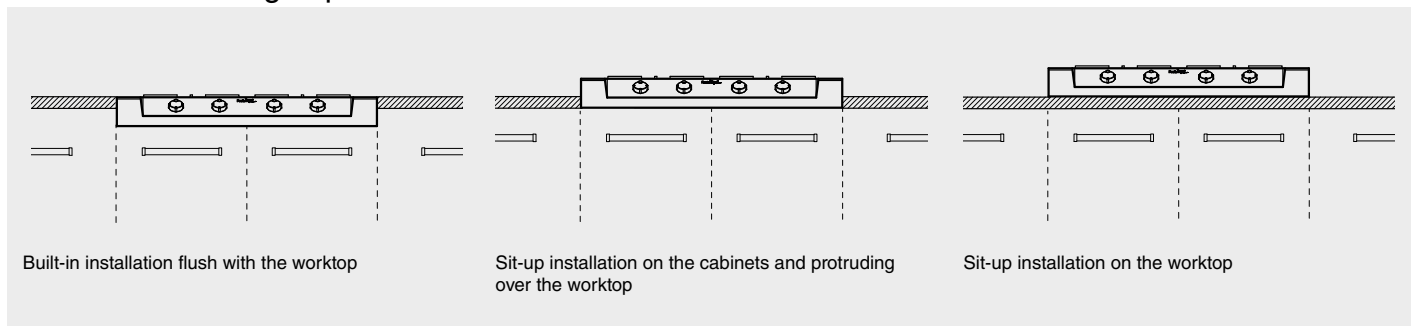

Inclined control board

In Rangetop versions, the knobs show to even greater advantage thanks to their frontal position and the inclination of the control board, which is therefore particularly practical. Their generous size and original shape guarantee an easy and safe grip. The under-knob ring is not only a fine stylistic detail, but also of great help when cleaning the hob.

Back shelf

The Milano Rangetop with the inline burners is also available with an elegant "back shelf" on which the most commonly used products can be stored: salt, spices and oil can thus be always at hand (ref. 3154 000).



GK

PERFORMANCE IN AN ELEGANT STYLE



High-Efficiency burners.
Up to 25% energy saving

Features | Version | Ref. | Technical Drawing



AISI 304 brushed cast iron grids and enamelled burner covers
Tot. power: 11.750 W
auxiliary: 2x1.000 W
semi-rapid: 1.750 W

rapid: 3.000 W
dual AE: 5.000 W
Electric ignition
Safety valves with ultra-rapid thermocouples

SF 7628 032

FT 7627 032
FTS

Supplied with: **4** (see page 114)

Flat-edge: **1294x470** - cut-out: **1274x450**
Flush-mount: **1294x470** - cut-out (FT): see web site
up-mount cut-out (FTS): **1274x450**

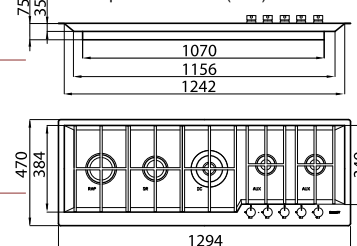

External dimensions refer to Flush-mount version



AISI 304 brushed cast iron grids and enamelled burner covers
Tot. power: 9.500 W
auxiliary: 1.000 W
semi-rapid: 2x1.750 W

dual AE: 5.000 W
Electric ignition
Safety valves with ultra-rapid thermocouples
Supplied with: **4** (see p. 114)

vintage versions



SF 7626 032

FT 7625 032
FTS

FT 7625 082
FTS

Flat-edge: **1050x470** - cut-out: **1030x450**
Flush-mount: **1050x470** - cut-out (FT): see web site
up-mount cut-out (FTS): **1030x450**

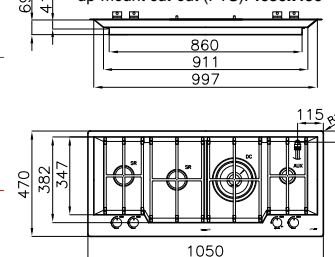

External dimensions refer to Flush-mount version

Easy Installation

GK combines generous dimensions with the ease of insertion into standard cabinets. **With 4 cm worktop thickness, the special shape of the box allows the fitting in 90 cm large cabinet.**













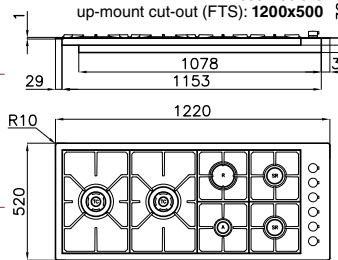

S4000

THE UNCOMPROMISING QUALITY

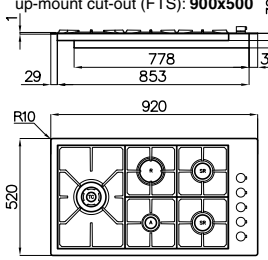

Cast-iron support included

 **New generation hobs.**
Up to 20% energy saving

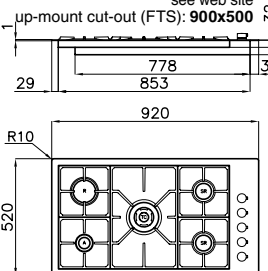
	Features	Version	Ref.	Technical Drawing
	<p>AISI 304 brushed Cast iron grids and enamel burner covers Tot. power: 15.200 W auxiliary: 1.100 W semi-rapid: 2x1.750 W</p> <p>rapid: 3.000 W triple crown: 2x3.800 W Electric ignition Safety valves with ultra-rapid thermocouples</p>	<p> Q4</p> <p> FT</p> <p> FTS</p>	<p>7272 032</p> <p>7273 032</p>	<p>Q4: 1220x520 - cut-out: 1160x480 Flush-mount: 1220x520 - cut-out (FT): see web site up-mount cut-out (FTS): 1200x500</p>  <p>External dimensions refer to Flush-mount version</p>
	<p>AISI 304 brushed Cast iron grids and enamel burner covers Tot. power: 11.400 W auxiliary: 1.100 W semi-rapid: 2x1.750 W rapid: 3.000 W triple crown: 3.800 W</p> <p>Electric ignition</p> <p>Safety valves with ultra-rapid thermocouples</p>	<p> Q4</p> <p> FT</p> <p> FTS</p>	<p>7252 032</p> <p>7257 032</p>	<p>Q4: 920x520 - cut-out: 860x480 Flush-mount: 920x520 - cut-out (FT): see web site up-mount cut-out (FTS): 900x500</p>  <p>External dimensions refer to Flush-mount version</p>
	<p>AISI 304 brushed Cast iron grids and enamel burner covers Tot. power: 11.400 W auxiliary: 1.100 W semi-rapid: 2x1.750 W rapid: 3.000 W triple crown: 3.800 W</p> <p>Electric ignition</p> <p>Safety valves with ultra-rapid thermocouples</p>	<p> Q4</p> <p> FT</p> <p> FTS</p>	<p>7270 032</p> <p>7271 032</p>	<p>Q4: 920x520 - cut-out: 860x480 Flush-mount: 920x520 - cut-out (FT): see web site up-mount cut-out (FTS): 900x500</p>  <p>External dimensions refer to Flush-mount version</p>

Supplied with: **1**
Accessories Q4: **2**
Accessories Flush-mount: **2 6** (see page 114)

Supplied with: **1**
Accessories Q4: **2**
Accessories Flush-mount: **2 6** (see page 114)

Supplied with: **1**
Accessories Q4: **2**
Accessories Flush-mount: **2 6** (see page 114)

S4000

Features	Version	Ref.	Technical Drawing
----------	---------	------	-------------------



AISI 304 brushed
Cast iron grids and
enamelled burner
covers
Tot. power: 11.750 W
semi-rapid: 1.750 W
dual AE: 2x5.000 W

 **Q4**
7280 032

Electric ignition

Safety valves
with ultra-rapid
thermocouples

Preparing for the Far East
markets available on request.

Q4: 890x520 - cut-out: 870x500

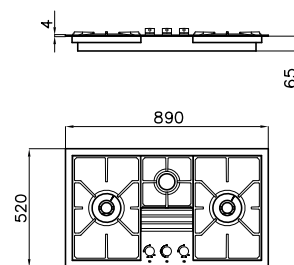

 **High-Efficiency burners.**
Up to 25% energy saving

Supplied with: 2x **4**, **6**

Accessories: **2** (see page 114)



AISI 304 brushed
Cast iron grids and
enamelled burner
covers
Tot. power: 12.350 W
auxiliary: 1.100 W
semi-rapid: 3x1.750 W
rapid: 2x3.000 W

 **Q4**
7253 032

 **FT**
7258 032

 **FTS**

Electric ignition

Safety valves
with ultra-rapid
thermocouples

Q4: 850x520 - cut-out: 830x480
Flush-mount: 850x520 - cut-out (FT): see web site
up-mount cut-out (FTS): 830x500

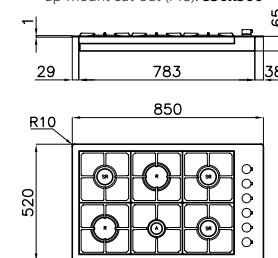

External dimensions refer to
Flush-mount version

Accessories Flush-mount: **6** (see page 114)



AISI 304 brushed
Cast iron grids and
enamelled burner
covers
Tot. power: 7.600 W
auxiliary: 1.100 W
semi-rapid: 2x1.750 W
rapid: 3.000 W

 **Q4**
7251 032

 **FT**
7256 032

 **FTS**

Electric ignition

Safety valves
with ultra-rapid
thermocouples

Q4: 620x520 - cut-out: 560x480
Flush-mount: 620x520 - cut-out (FT):
see web site
up-mount cut-out (FTS): 600x500

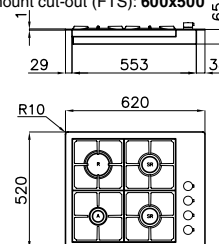

External dimensions refer to
Flush-mount version

Accessories Flush-mount: **6** (see page 114)

A versatile pot support

The flush-mount versions are supplied with the pot support accessory (Ref. 9601 742) that increases the work surface and safeguards the worktop against accidental contact with hot pots. It is a standard feature available on all S4000 Domino hobs.



S4000 Line XL

CHAMPION OF FUNCTIONALITY





 **New generation hobs.**
Up to 20% energy saving

Features	Version	Ref.	Technical Drawing
----------	---------	------	-------------------







AISI 304 brushed
Cast iron grids and
enamelled burner covers
Tot. power 9.650 W
auxiliary: 1.100 W
semi-rapid: 1.750 W

rapid: 3.000 W
triple crown: 3.800 W
Electric ignition
Safety valves
with ultra-rapid
thermocouples

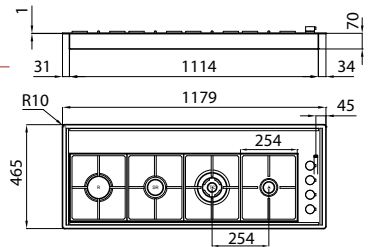
 FT
7284 032
 FTS

Flush-mount: **1179x465** - cut-out (FT):
see web site
up-mount cut-out (FTS): **1162x448**





Supplied with: 4x , 
Accessories: ,  (see page 114)







AISI 304 brushed
Cast iron grids and
enamelled burner covers
Tot. power 6.650 W
auxiliary: 1.100 W
semi-rapid: 1.750 W

triple crown: 3.800 W
Electric ignition
Safety valves
with ultra-rapid
thermocouples

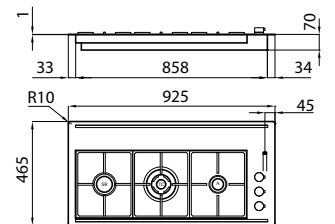
 FT
7285 032
 FTS

Flush-mount: **925x465** - cut-out (FT):
see web site
up-mount cut-out (FTS): **908x448**



Supplied with: 3x , 
Accessories: ,  (see page 114)

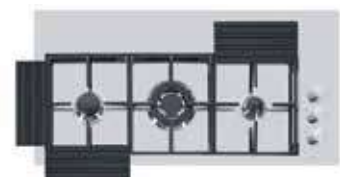







XL versions are characterized by the greater depth of the steel lip, on which are positioned elegant cast iron elements. These are removable and also may be placed in the front of the hob, or used as a support for the pots on the table.

S4000 Line

A LINEAR CONCEPT OF PRACTICALITY

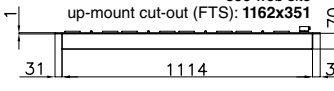
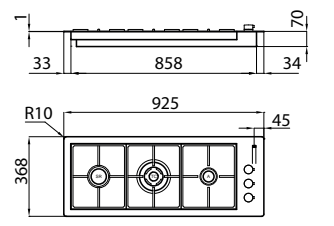

 **New generation hobs.**
Up to 20% energy saving

Features	Version	Ref.	Technical Drawing
 Q4  SF  FT  FTS	<p>7254 032</p> <p>7250 032</p> <p>7259 032</p>	<p>7254 032</p> <p>7250 032</p> <p>7259 032</p> <p>7286 032</p>	<p>Q4: 1179x368 - cut-out: 1159x348 Flat-edge: 1179x368 - cut-out: 1162x351 Flush-mount: 1179x368 - cut-out (FT): see web site up-mount cut-out (FTS): 1162x351</p>  <p>External dimensions refer to Flush-mount version</p> <p>Flush-mount: 925x368 - cut-out (FT): see web site up-mount cut-out (FTS): 908x351</p> 
<p>AISI 304 brushed Cast iron grids and enamelled burner covers Tot. power: 9.650 W auxiliary: 1.100 W semi-rapid: 1.750 W</p> <p>rapid: 3.000 W triple crown: 3.800 W Electric ignition Safety valves with ultra-rapid thermocouples</p> <p>Supplied with: 1 Accessories Q4 and Flat-edge: 2 Accessories Flush-mount: 2 6 (see page 114)</p>	<p>AISI 304 brushed Cast iron grids and enamelled burner covers Tot. power 6.650 W auxiliary: 1.100 W</p> <p>semi-rapid: 1.750 W triple crown: 3.800 W Electric ignition Safety valves with ultra-rapid thermocouples</p> <p>Supplied with: 1 Accessori Q4 e semifilo: 2 Accessori Filotop: 2 6 (see page 114)</p>	 	

Elegant metallic knob

The entire 4000 Series is equipped with the new elegant and plain knob. As on all Foster cooker hobs, the appliances have under-knob ignition. Moreover, ignition is now even quicker thanks to the new burners.



S4000 Domino

MODULAR QUALITY



 **High-Efficiency burners.**
Up to 25% energy saving

Features	Version	Ref.	Technical Drawing
----------	---------	------	-------------------



AISI 304 brushed
Cast iron grids and
enamel burner
covers
Tot. power: 5.000 W
dual AE: 5.000 W



7278 032

Electric ignition

Safety valves
with ultra-rapid
thermocouples

Version for Far East
markets available on request.

Q4: 450x520 - cut-out: 430x480

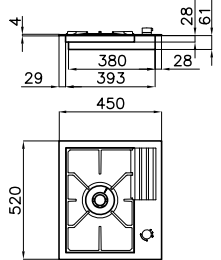

Supplied with: **4** , **6**
Accessories: **2** (see page 114)

Notes for fixing on the worktop: see page 155



AISI 304 brushed
Cast iron grids and
enamel burner
covers
Tot. power: 4.500 W
dual: 4.500 W



7277 032

Electric ignition

Safety valves
with ultra-rapid
thermocouples

Q4: 450x520 - cut-out: 430x480

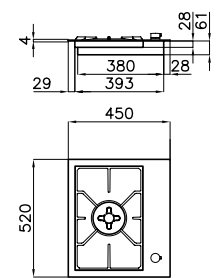

Supplied with: **4** , **6**
Accessories: **2** (see page 114)

Notes for fixing on the worktop: see page 155



AISI 304 brushed
Cast iron grids and
enamel burner
covers
Tot. power: 2.750 W
auxiliary AE: 1.000 W
semi-rapid AE: 1.750 W



7276 032

Electric ignition

Safety valves
with ultra-rapid
thermocouples

Q4: 380x520 - cut-out: 360x480

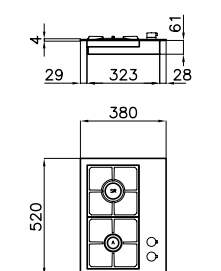





Supplied with: **6** (see page 114)

Notes for fixing on the worktop: see page 155

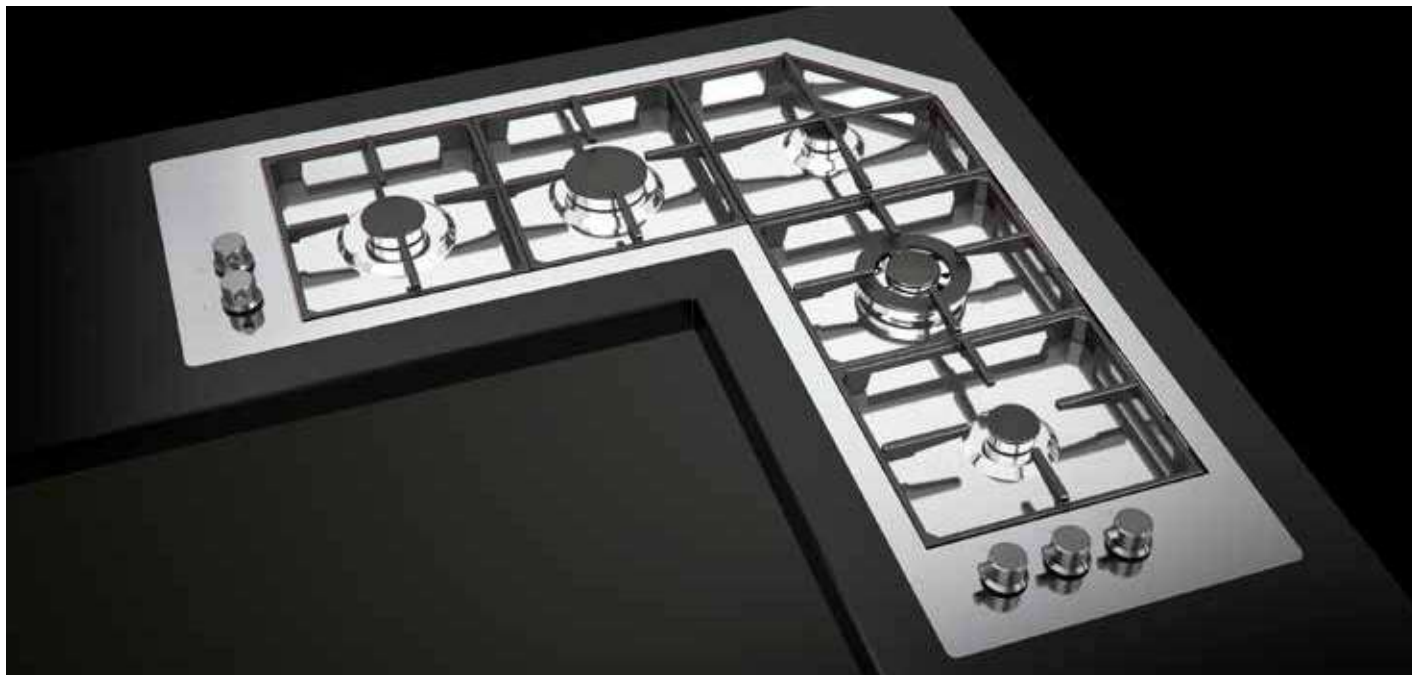
Quadra Angolare

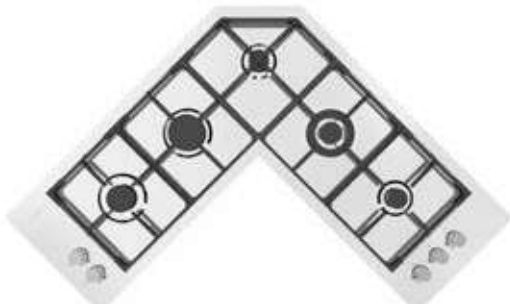
A PERFORMING COOKING CORNER

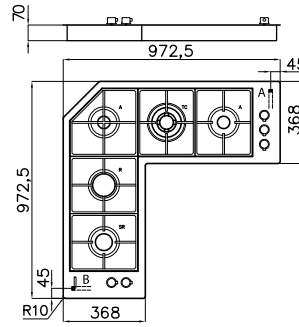

Features	Version	Ref.	Technical Drawing
	 SF	7235 042	Flat-edge: 972x972 - cut-out: see web site Flush-mount: 972x972 - cut-out (FT): see web site up-mount cut-out (FTS): see web site
	 FT	7238 042	
	 FTS		
<p>AISI 304 brushed Cast iron grids and enamelled burner covers Tot. power: 9.950 W auxiliary: 2x1.000 W semi-rapid: 1.750 W</p>	<p>rapid: 2.700 W triple crown: 3.500 W Electric ignition Safety valves with ultra-rapid thermocouples</p>	<p><i>Connection to the gas supply network must be carried out through both inlets (A and B)</i></p>	
<p>Accessories: 1 (see page 114)</p>			



A smart corner









Thanks to its broad front work surface, the Quadra Corner cooker hob allows for optimally exploiting corner spaces.

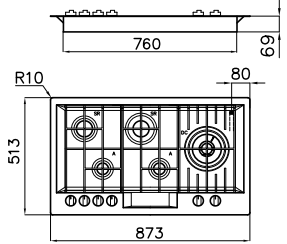

FL

PERFORMANCE AND EFFICIENCY WITH STYLE

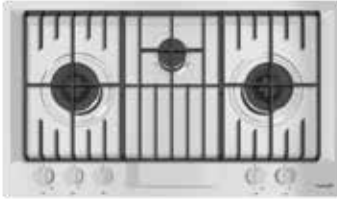

 **High-Efficiency burners**
Up to 25% energy saving

	Features	Version	Ref.	Technical Drawing
 <p>Supplied with: 4</p>	<p>AISI 304 brushed Cast iron grids and enamel burner covers Tot. power 10.500 W auxiliary: 2x1.000 W dual AE: 5.000 W semi-rapid: 2x1.750 W</p> <p>Electric ignition</p> <p>Safety valves with ultra-rapid thermocouples</p>		7201 032	<p>Standard: 860x500 - cut-out: 840x480 Flat-edge: 873x513 - cut-out: 840x480 Flush-mount: 873x513 - cut-out (FT): see web site up-mount cut-out (FTS): 860x500</p> 
			7205 032	
			7206 032	
				
<p>version vintage</p> 			7206 082	<p>External dimensions refer to Flush-mount version</p>

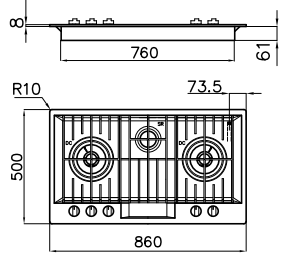
 <p>Supplied with: 2x 4</p>	<p>AISI 304 brushed Cast iron grids and enamel burner covers Tot. power 11.750 W semi-rapid: 1.750 W dual AE: 2x5.000 W</p> <p>Electric ignition</p> <p>Safety valves with ultra-rapid thermocouples</p>		7202 032	<p>Standard: 860x500 - cut-out: 840x480</p> 
--	--	---	----------	---

4  Wok support
9601 727

Ultra-flat grids

The sturdy cast iron grids form a single surface on which you can move pans easily and in complete safety.

5 kW burner

FL cooker hob feature a powerful 5kw burner with two totally independent crown of flames, controlled by two different knobs.



FL

Features	Version	Ref.	Technical Drawing
----------	---------	------	-------------------



AISI 304 brushed
Cast iron grids and
enamelled burner
covers
Tot. power 10.000 W
dual AE: 2x5.000 W

STD 7203 032

Electric ignition

Safety valves with
ultra-rapid
thermocouples

Standard: 760x500 - cut-out: 740x480

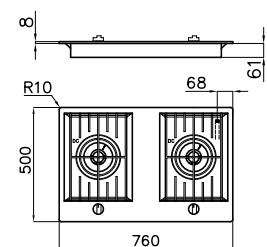

Supplied with: 2x **4**

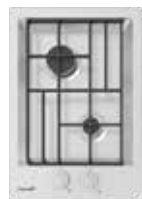

AISI 304 brushed
Cast iron grids and
enamelled burner
covers
Tot. power 2.750W
auxiliary: 1.000 W
semi-rapid: 1.750 W

SF 7209 032

Electric ignition

Safety valves with
ultra-rapid
thermocouples

FT 7208 032

FTS

Flat-edge: 353x513 - cut-out: 320x480
Flush-mount: 353x513 - cut-out (FT):
see web site
up-mount cut-out (FTS): 340x500

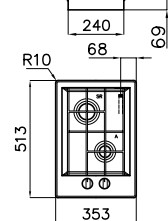

AISI 304 brushed
Cast iron grids and
enamelled burner
covers
Tot. power 5.000 W
dual AE: 5.000 W

SF 7204 032

Electric ignition

Safety valves with
ultra-rapid
thermocouples

FT 7207 032

FTS

Flat-edge: 353x513 - cut-out: 320x480
Flush-mount: 353x513 - cut-out (FT):
see web site
up-mount cut-out (FTS): 340x500

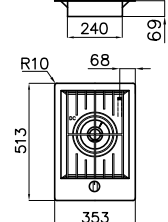

Supplied with: **4**



Thanks to the powerful (con una L. sola!) and versatile AE Dual burner, the FL domino is a complete hob even with its single burner. It is possible to supply little power for a single-cup moka, or up to 5000 W to boil water or cook with a wok.















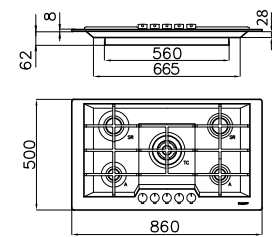

On five-burners and three-burners models, AE dual is even more flexible thanks to a twin-knobs system that allows to have the two completely independent crowns of flames.

KE

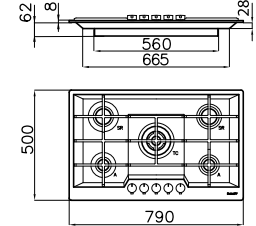
QUALITY OF FORM AND SUBSTANCE

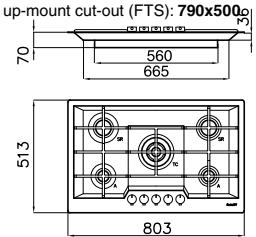

 **New generation hobs.**
Up to 20% energy saving

	Features	Version	Ref.	Technical Drawing
	<p>AISI 304 brushed Cast iron grids and enamelled burner covers Tot. power: 9.500 W auxiliary: 2x1.100 W semi-rapid: 2x1.750 W triple crown: 3.800 W</p> <p>Electric ignition</p> <p>Safety valves with ultra-rapid thermocouples</p>	<p> STD</p> <p> STD</p> <p> Microfoster</p>	<p>7603 032</p> <p>7603 432</p>	<p>Standard: 860x500 - cut-out: 840x480</p> 
<p>Accessories: 4 (see page 114)</p> 	<p>AISI 304 brushed Cast iron grids and enamelled burner covers Tot. power: 9.500 W auxiliary: 2x1.100 W semi-rapid: 2x1.750 W triple crown: 3.800 W</p> <p>Electric ignition</p> <p>Safety valves with ultra-rapid thermocouples</p>	<p> STD</p> <p> STD</p> <p> Microfoster</p>	<p>7602 032</p> <p>7602 432</p>	<p>Standard: 790x500 - cut-out: 750x480</p> 
<p>Accessories: 4 (see page 114)</p> 	<p>AISI 304 brushed Cast iron grids and enamelled burner covers Tot. power: 9.500 W auxiliary: 2x1.100 W semi-rapid: 2x1.750 W triple crown: 3.800 W</p> <p>Electric ignition</p> <p>Safety valves with ultra-rapid thermocouples</p>	<p> Q4</p> <p> SF</p> <p> FT</p> <p> FTS</p>	<p>7605 032</p> <p>7600 032</p> <p>7601 032</p>	<p>Q4: 810x520 - cut-out: 770x480 Flat-edge: 803x513 - cut-out (FT): Flush-mount: 803x513 - cut-out (FT): see web site up-mount cut-out (FTS): 790x500</p>  <p>External dimensions refer to Flush-mount version</p>

KE Black NEW

A SPORTY AND GRITTY DESIGN



 **New generation hobs.**
Up to 20% energy saving

Features	Version	Ref.	Technical Drawing
----------	---------	------	-------------------



AISI 304 brushed
Cast iron grids,
gun metal burners
and enamelled
burner covers
Tot. power: 9.500 W
auxiliary: 2x1.100 W
semi-rapid: 2x1.750 W
triple crown: 3.800 W

 **7600 632**

Flat-edge: **803x513** - cut-out: **770x480**

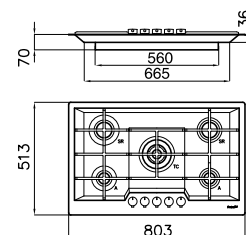

Electric ignition

Safety valves
with ultra-rapid
thermocouples

Accessories: **4** (see page 114)



The KE hob "Sports version"
The gun metal burners give a black sporty and aggressive look even stronger with the addition of the knobs in Gun Metal finish, available as an accessory.

cod. 9601 299



KE White

WHITE AND STEEL. A VERY ELEGANT MIX



 **New generation hob.**
Up to 20% energy saving

Features	Version	Ref.	Technical Drawing
----------	---------	------	-------------------



AISI 304 brushed
White enamelled grids
and steel burner covers
Tot. power: 9.500 W
auxiliary: 2x1.100 W
semi-rapid: 2x1.750 W
triple crown: 3.800 W



7600 132

Electric ignition

Safety valves
with ultra-rapid
thermocouples

Flat-edge: 803x513 - cut-out: 770x480

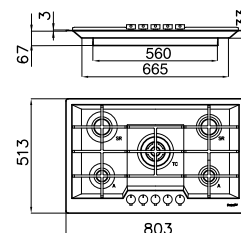

Accessories: **4** (see page 114)

features



**Elegance to put on display
and practicality in cooking.**

KE white comes with refined
steel burner covers.
The enamelled burner covers
kit, more practical for daily use,
is also available on request.

code 9601 480







KE White, a new elegance: the special high-resistance
white enamelled cast iron grids and burners steel
details are an expression of uniqueness and refinement.

KE Line

THE LINE IN A LIGHTWEIGHT AND ORIGINAL DESIGN



 **New generation hob.**
Up to 20% energy saving

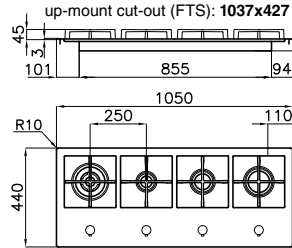





	Features	Version	Ref.	Technical Drawing
	<p>AISI 304 brushed Cast iron grids and enamel burner covers Tot. power: 9.650 W auxiliary: 1.100 W semi-rapid: 1.750 W rapid: 3.000 W triple crown: 3.800 W</p> <p>Electric ignition</p> <p>Safety valves with ultra-rapid thermocouples</p>	<p> SF</p> <hr/> <p> FT</p> <p> FTS</p>	<p>7606 032</p> <hr/> <p>7607 032</p>	<p>Flat-edge: 1050x440 - cut-out: 1030x420 Flush-mount: 1050x440 - cut-out (FT): see web site up-mount cut-out (FTS): 1037x427</p>  <p>External dimensions refer to Flat-edge version</p>

Accessories: **4** (see page 114)

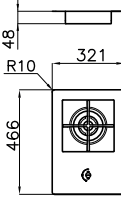

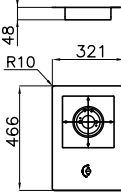
A detail of the precious knob and of the highly performing burners of KE hobs.

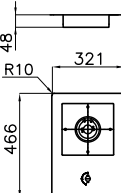
KE Domino

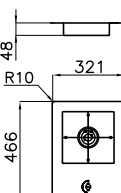
	Features	Version	Ref.		Technical Drawing	
	<p>AISI 304 brushed Cast iron grids and enamelled burner covers triple crown: 3.800 W</p> <p>Electric ignition</p> <p>Safety valves with ultra-rapid thermocouples</p>	<p>FT FTS</p>	<p>7624 032</p>		<p>Flush-mount: 321x466 - cut-out (FT): see web site up-mount cut-out (FTS): 309x454</p> 	
<p>Accessories: 4 (see page 114)</p>		<p>AISI 304 brushed Cast iron grids and enamelled burner covers rapid: 3.000 W</p> <p>Electric ignition</p> <p>Safety valves with ultra-rapid thermocouples</p>	<p>FT FTS</p>	<p>7623 032</p>		<p>Flush-mount: 321x466 - cut-out (FT): see web site up-mount cut-out (FTS): 309x454</p> 
	<p>AISI 304 brushed Cast iron grids and enamelled burner covers semi-rapid: 1.750 W</p> <p>Electric ignition</p> <p>Safety valves with ultra-rapid thermocouples</p>	<p>FT FTS</p>	<p>7622 032</p>		<p>Flush-mount: 321x466 - cut-out (FT): see web site up-mount cut-out (FTS): 309x454</p> 	
	<p>AISI 304 brushed Cast iron grids and enamelled burner covers auxiliary: 1.100 W</p> <p>Electric ignition</p> <p>Safety valves with ultra-rapid thermocouples</p>	<p>FT FTS</p>	<p>7621 032</p>		<p>Flush-mount: 321x466 - cut-out (FT): see web site up-mount cut-out (FTS): 309x454</p> 	

 **New generation hobs.**
Up to 20% energy saving

Marine

A SUPER STEEL FOR A CHAMPION OF FUNCTIONALITY



Features	Version	Ref.	Technical Drawing
----------	---------	------	-------------------



AISI 316 brushed
 Cast iron grids and
 enamelled burner
 covers
 Tot. power: 9.750 W
 auxiliary: 1.000 W
 semi-rapid: 3x1.750 W
 triple crown: 3.500 W

Electric ignition

Safety valves
 with ultra-rapid
 thermocouples



Flat-edge: 803x513 - cut-out: 770x480

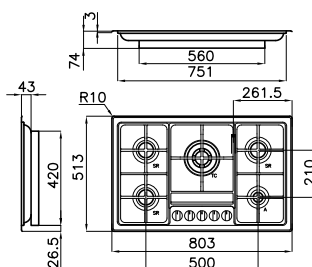

Accessories: **4** (see page 114)

Marine sinks see page 37

Details

Detail of the precious knob of the Marine cooker hob, with its elegant satin-finish that matches the hob's surface finish.

The Marine sinks and hobs feature the elegant half-flush inclined edge, which protrudes only 3 mm from the worktop.

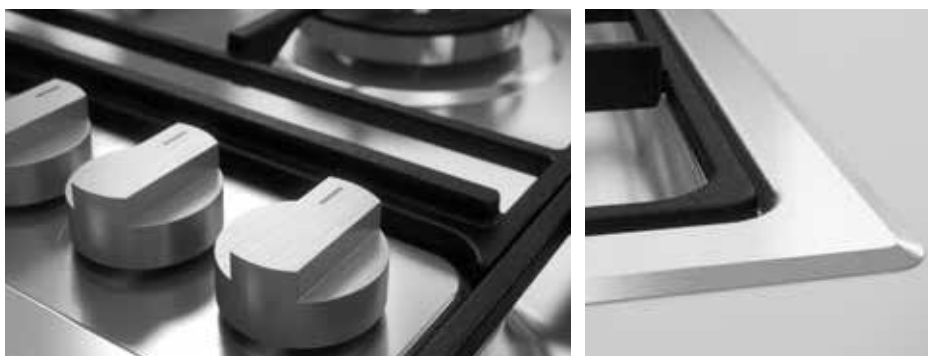





KS

REFINED ELEGANCE

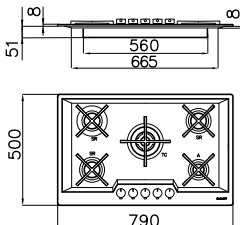

 **New generation hobs.**
Up to 20% energy saving

	Features	Version	Ref.	Technical Drawing
	<p>AISI 304 brushed Cast iron grids and enamelled burner covers Tot. power: 10.150 W auxiliary: 1.100 W semi-rapid: 3x1.750 W triple crown: 3.800 W</p> <p>Electric ignition</p> <p>Safety valves with ultra-rapid thermocouples</p>	<p> STD</p>	<p>7610 032</p>	<p>Standard: 790x500 - cut-out: 750x480</p> 
Accessories: 4 (see page 114)				

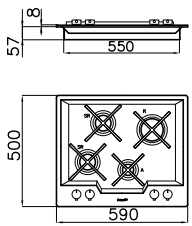
	<p>AISI 304 brushed Cast iron grids and enamelled burner covers Tot. power: 7.600 W auxiliary: 1.100 W semi-rapid: 2x1.750 W rapid: 3.000 W</p> <p>Electric ignition</p> <p>Safety valves with ultra-rapid thermocouples</p>	<p> STD</p>	<p>7615 032</p>	<p>Standard: 590x500 - cut-out: 560x480</p> 
--	--	--	-----------------	---

Sloped recess













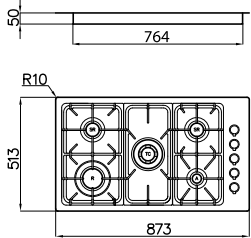

The sloped recess conveys a modern, elegant touch besides facilitating the cleaning of the corners. A piece of highly refined workmanship to be found on both the KE and KS ranges.

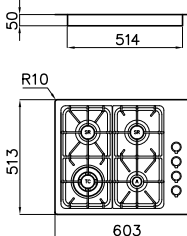

Professionale

A PERFORMING AND PRACTICAL EVERGREEN









	Features	Version	Ref.	Technical Drawing
	AISI 304 brushed Cast iron grids and enamelled burner covers Tot. power: 10.700 W auxiliary: 1.000 W semi-rapid: 2x1.750 W rapid: 2.700 W triple crown: 3.500 W Electric ignition Safety valves with ultra-rapid thermocouples		7055 062	Standard: 860x500 - cut-out: 840x480 Flat-edge: 873x513 - cut-out (FT): 840x480 Flush-mount: 873x513 - cut-out (FT): see web site up-mount cut-out (FTS): 860x500 
		 	7055 462	
			7246 062	
		 	7245 062	
Accessories: 1 2 3 (see page 114)				External dimensions refer to Flush-mount version
	AISI 304 brushed Cast iron grids and enamelled burner covers Tot. power: 8.000 W auxiliary: 1.000 W semi-rapid: 2x1.750 W triple crown: 3.500 W Electric ignition Safety valves with ultra-rapid thermocouples		7053 062	Standard: 590x500 - cut-out: 560x480 Flat-edge: 603x513 - cut-out (FT): 560x480 Flush-mount: 603x513 - cut-out (FT): see web site up-mount cut-out (FTS): 590x500 
			7244 062	
		 	7243 062	
		Accessories: 1 2 (see page 114)		

Veronika Flush-mount

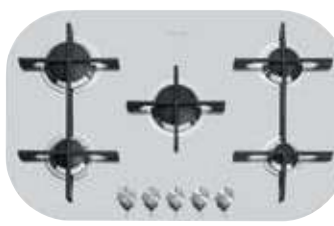
SINUOUS ELEGANCE

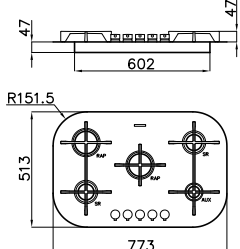

 **New generation hob.**
Up to 20% energy saving

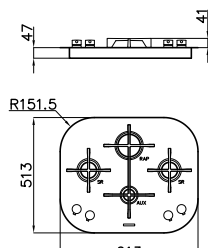
	Features	Version	Ref.	Technical Drawing
	<p>AISI 304 brushed Cast iron grids and enamelled burner covers Tot. power: 10.600 W auxiliary: 1.100 W semi-rapid: 2x1.750 W rapid: 2x3.000 W</p> <p>Electric ignition</p> <p>Safety valves with ultra-rapid thermocouples</p>	<p> FT</p> <p> FTS</p>	<p>7367 032</p>	<p>Flush-mount: 773x513 - cut-out (FT): see web site up-mount cut-out (FTS): 760x500 R 145</p> 
	<p>AISI 304 brushed Cast iron grids and enamelled burner covers Tot. power: 7.600 W auxiliary: 1.100 W semi-rapid: 2x1.750 W rapid: 3.000 W</p> <p>Electric ignition</p> <p>Safety valves with ultra-rapid thermocouples</p>	<p> FT</p> <p> FTS</p>	<p>7266 032</p>	<p>Flush-mount: 613x513 - cut-out (FT): see web site up-mount cut-out (FTS): 600x500 R 145</p> 

Matchings



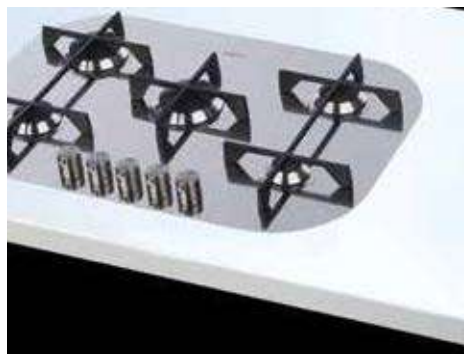



Veronika flush-mount versions feature large radiused shapes that perfectly match Big Bowl and Tornado flush-mount sinks.

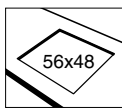
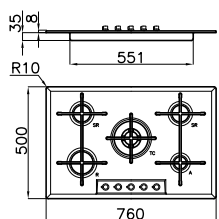

Veronika

THE PRACTICALITY OF A STREAMLINED, FLAT HOB

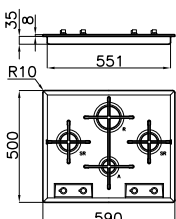

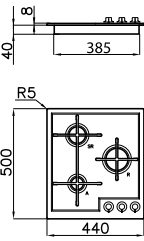

	Features	Version	Ref.		Technical Drawing
 <p data-bbox="67 1335 338 1361">Accessories: 4 (see page 114)</p>	<p data-bbox="513 994 687 1200">AISI 304 brushed Cast iron grids and enamelled burner covers Tot. power: 10.700 W auxiliary: 1.000 W semi-rapid: 2x1.750 W rapid: 2.700 W triple crown: 3.500 W</p> <p data-bbox="513 1218 644 1245">Electric ignition</p> <p data-bbox="513 1263 644 1335">Safety valves with ultra-rapid thermocouples</p>		<p data-bbox="826 1032 911 1055">7067 062</p>	<p data-bbox="927 1335 1038 1357">Strait cut-out</p> 	<p data-bbox="1225 981 1497 1003">Standard: 760x500 - cut-out: 560x480</p>  <p data-bbox="1241 1317 1497 1357">Model which cannot be welded into stainless steel worktops</p>
	<p data-bbox="513 1391 687 1570">AISI 304 brushed Cast iron grids and enamelled burner covers Tot. power: 7.200 W auxiliary: 1.000 W semi-rapid: 2x1.750 W rapid: 2.700 W</p> <p data-bbox="513 1592 644 1615">Electric ignition</p> <p data-bbox="513 1637 644 1704">Safety valves with ultra-rapid thermocouples</p>		<p data-bbox="826 1429 911 1451">7066 052</p>		<p data-bbox="1225 1379 1497 1402">Standard: 590x500 - cut-out: 560x480</p>  <p data-bbox="1241 1709 1497 1749">Model which cannot be welded into stainless steel worktops</p>
	<p data-bbox="513 1809 687 1989">AISI 304 brushed Cast iron grids and enamelled burner covers Tot. power: 5.850 W auxiliary: 1.100 W semi-rapid: 1.750 W rapid: 3.000 W</p> <p data-bbox="513 2011 644 2033">Electric ignition</p> <p data-bbox="513 2056 644 2123">Safety valves with ultra-rapid thermocouples</p>		<p data-bbox="826 1825 911 1848">7063 042</p>		<p data-bbox="1225 1776 1497 1798">Standard: 440x500 - cut-out: 420x480</p> 



 **New generation hob.**
Up to 20% energy saving

Electra

CHAMPION OF CONVENIENCE

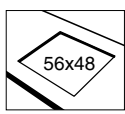
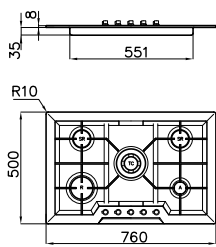

	Features	Version	Ref.		Technical Drawing
 <p>Accessories: 1 2 (see page 114)</p>	<p>AISI 304 brushed Cast iron grids and enamelled burner covers Tot. power: 10.700 W auxiliary: 1.000 W semi-rapid: 2x1.750 W rapid: 2.700 W triple crown: 3.500 W</p> <p>Electric ignition</p> <p>Safety valves with ultra-rapid thermocouples</p>	<p> STD</p>	<p>7064 062</p> <p style="text-align: center;">Strait cut-out</p> 		<p>Standard: 760x500 - cut-out: 560x480</p>  <p>Model which cannot be welded into stainless steel worktops</p>

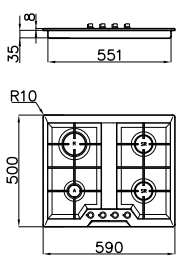
	<p>AISI 304 brushed Cast iron grids and enamelled burner covers Tot. power: 7.200 W auxiliary: 1.000 W semi-rapid: 2x1.750 W rapid: 2.700 W</p> <p>Electric ignition</p> <p>Safety valves with ultra-rapid thermocouples</p>	<p> STD</p>	<p>7068 042</p>		<p>Standard: 590x500 - cut-out: 560x480</p>  <p>Model which cannot be welded into stainless steel worktops</p>
--	--	--	-----------------	--	---

Smart grids

A detail of sturdy square grids of Electra hob: just two symmetrical grids create the support for all the five burners.



Angolare

THE CORNER IN A PROFESSIONAL STYLE



Features

Version

Ref.

Technical Drawing

Standard: 830x830 - cut-out: see web site

 STD 7038 052

AISI 304 brushed
Cast iron grids and
enamelled burner
covers
Tot. power: 9.750 W
auxiliary: 1.000 W
semi-rapid: 3x1.750 W
triple crown: 3.500 W

Electric ignition

Safety valves
with ultra-rapid
thermocouples

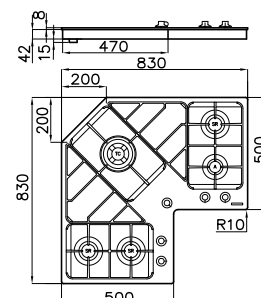

Accessories: **1** **2** (see page 114)

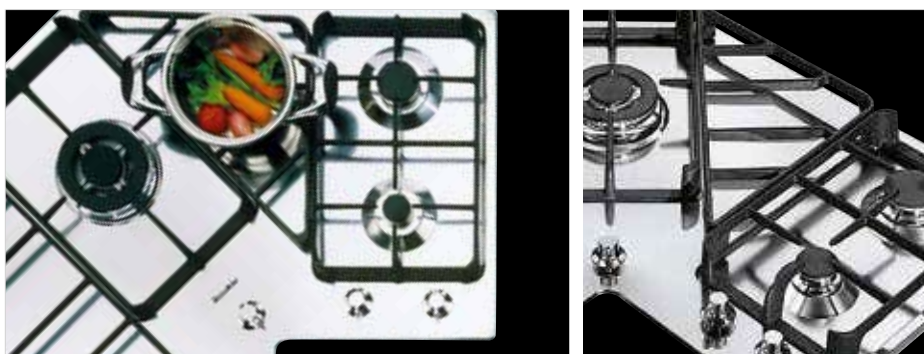





Foster's Angolare hob maximizes space thanks to the cast iron "pan-support" zones that create a continuous surface with the grids on cooking zones.

Rondò

A CHAMPION FOR SMALL SPACES

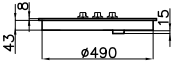
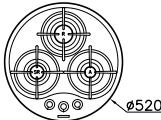

	Features	Version	Ref.	Technical Drawing
	<p>AISI 304 brushed Cast iron grids and enamel burner covers Tot. power: 5.450 W auxiliary: 1.000 W semi-rapid: 1.750 W rapid: 2.700 W</p> <p>Electric ignition</p> <p>Safety valves with ultra-rapid thermocouples</p>	<p> STD Spazzolato</p>	<p>7052 022</p>	<p>Standard: Ø 520 - cut-out: Ø 500</p>  
		<p> STD Microfoster</p>	<p>7052 442</p>	

Accessories: **5** (see page 114)



The Rondò series received a special mention of merit at the prestigious ADI "Golden Compass" international design competition.



Induction and Electric Hobs

Excellent performance and cutting-edge technology characterise Foster electric cooker hobs. A completely redesigned range that strikes the perfect blend of efficiency and design with the induction hobs.

Foster Milano Air p. 146



S4000 Induction Bridge p. 148



S4000 Induction con Power Control p. 149



S4000 Induction p. 150



Elettra Induction p. 151



S1000 Induction p. 152



S4000 Domino p. 153



Modular Induction p. 156



Vitroline Hi-light p. 159



Induction PRO Pots collection p. 160



The advantages of the induction technology



Control

Great versatility and accurate control are peculiar features of induction cooking. The nine possible power settings (with additional Powerboost options) offer a wide spectrum of possibilities, ranging from simple food heat maintenance to an incredible net available power compared to other cooking systems.

Security

The surface of the hob is heated only by pot contact and reaches no searing temperatures. Moreover, the simple act of removing the pot automatically shuts off the hob. The sophisticated electronics of Foster hobs completes their equipment in terms of security systems thanks to Pot Detector, Overflow Detector, Automatic Power-Off and Safety Lock.

Cleaning

The cooking area is activated only on the surface directly in contact with the saucepan; the rest of the cooking area remains cool, which means that over-spilled food will not burn and will not produce unpleasant deposits that are difficult to remove. Cleaning is so simple and fast and hygiene is perfect.

High speed

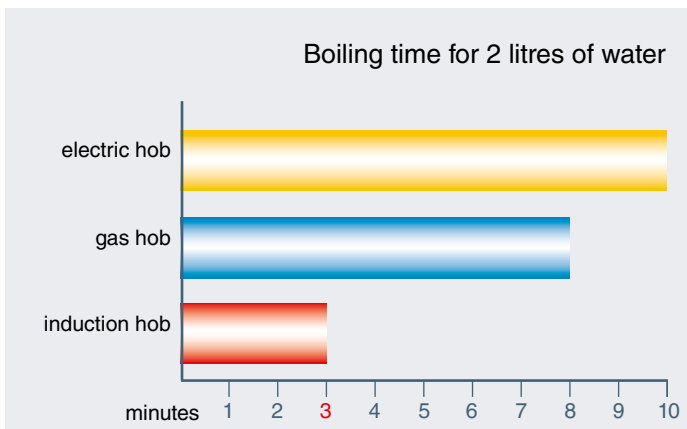

Great efficiency

	power absorption	net power	yield
electric hob	2.000 W	1.000 W	50%
gas hob	1.820 W	1.000 W	55%
induction hob	1.100 W	1.000 W	90%

Energy saving



Thanks to its great speed in bringing the liquid to boil and its efficiency highly above all other cooking systems, induction involves a significant energy saving and represent **the most economical choice**.

Absorption examples for different types of cooking

cooking levels	power	kind of cooking	examples
1-2	50-130 W	very light	melt, bain-marie
3-4	150-300 W	light	warm, simmer
5-7	350-750 W	medium	sauces, rice
7-9	1.000-2.300 W	intense	roast meat, fry
Powerboost	1.400-3.000 W	time reduction	liquids boiling

The induction high power level leads us to believe in a great commitment of energy. By contrast, as can be seen in the table, most types of cooking require low power.

New Bridge technology



Extended cooking area

The new hobs with Bridge function allow to associate two zones forming a single extended cooking zone for pots of large size, or for more than one cooking simultaneously, with maximum flexibility in pot positioning. With the additional Double Booster feature provided by all Bridge hobs, the exceptional 3700 W power can be concentrated on a single plate or made available uniformly over the enlarged area.



Features of Foster Bridge technology

The innovative rectangular shape of Bridge induction plates provides maximum efficiency over the entire cooking area. The possibility of dosing the entire power on individual plates or on the whole surface, allows the best performances both with pots of large and small size. Activation of the Bridge function is intuitive and straightforward: the entire area is then managed with a single Slider command.

PowerControl





PowerControl function allows the use of induction technology also in case of household maximum power as low as 3 kW. The maximum power can indeed be self-limited to the desired level to a minimum of 2.8 kW. Once the maximum power is set, we can forget about the absorbed energy because Foster induction hob will give us a warning about possible limitations, allowing to choose how to allocate the available energy. The hob can be easily reprogrammed at any time to modify or remove the power limit.

Models with power limitation:

- S4000 power control, page 149
- S1000, page 152

Built-in solutions

Induction and electric hobs can be installed either on the top or with the flush-mount method, by creating a recess in the worktop the same depth as the thickness of the glass.

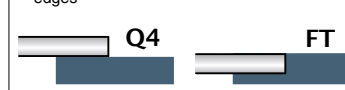
 <p>inset options for models with bevelled edges</p>	<p>Bevelled edge Special slanting edge (bevelled) that gives a clean and elegant finish with both the installation methods (flush-mount and top-mount) and perfectly matches the flat-edge sinks.</p>	
 <p>inset options for models with vertical edges</p>	<p>Vertical edge The casing has a square edge that stands over the work surface by just 4 mm. The vertical ceramic-glass profile allows both top-mount and flush-mount installation.</p>	



Powerboost

Foster induction hobs are equipped with Booster function [P], which provides increased power to the selected plate. In particular, when the Booster is activated, the plate works for ten minutes at a very high power that allows to heat quickly large quantities of water.

Quantity	Without Powerboost	With Powerboost
3 litres	5 min.	3 min.
5 litres	8 min.	5 min.

Boiling timing with or without Powerboost



Slider control operation

The Slider control allows for extremely quick temperature setting: with a light touch of the finger you may select the desired power level on the TOUCH display.



T-chef

It is a function that allows to set particular temperatures (42 °C, 70 °C, 84 °C) and keep them constant during cooking. Elaborate preparations can be easily obtained, with chef-like results. Cooking in a bain-marie, without the aid of a double container for the water, custard or cream sauce will thus always be perfect. By setting the temperature close to boiling, liquids will immediately reach the requested temperature, increasing speed and performance.



Heat maintenance

Function that allows the food to be kept warm gently (70° C), without reaching boiling temperatures or risking to burn the sauce.



Full Safety System

All electric cooker hobs feature the most modern and sophisticated safety protections: **Centralised power-off function**; Child-proof **safety lock**; **Residual heat warning lights**. Induction models feature the following functions: **Safety System** that turn off the hob in the absence of the pot; **Overflow detector** that automatically turns off the plate in case of liquid overflow; **Automatic deactivation** to prevent accidents caused by forgetfulness.



Double Powerboost

On the new models with Bridge technology the Double Booster function is available: two further levels of power up to 3700 W, to be used on a single zone or distributed over the entire Bridge-extended area (where available).



End-of-cooking programming

All operations are programmed by means of the touch-control on the glass itself. Each cooking plate is capable of independent programming, and thus the possibility to set different cooking times.



Timer

On several models a further timer, independent from the end-of-cooking function, is available.



Pot detector

All induction cooker hobs detect the pot resting on them, but they also calculate the area they cover. This system allows the energy to be used even more efficiently. Moreover, the plates switch off automatically when the pot is removed.



Smart Fan System

Correct ventilation is essential for the induction hob to function in the best possible way. The Foster system automatically regulates the amount of ventilation to suit the temperatures reached.



Go&Stop device

This device initially turns on the plates at maximum power until the selected temperature has been reached.



Recall

This feature allows you to call back the last settings selected in the previous cooking.



Pause

Useful function that allows you to distract your attention from cooking, interrupting and restoring the settings immediately.

Installation in the cabinet

To ensure optimal functioning, induction hobs require adequate aeration. We suggest leaving a space of at least 50 mm between cooker hob and the back or side walls.

In order to prevent any leakages into the appliance's cut-out, Foster recommends applying a coat of paint or a sealant between the cooker hob and worktop.

Do not install the hob above an oven that is not adequately ventilated, or above a dishwasher.

Ensure that there is a gap of at least 20 mm below the appliance's box so as to allow for sufficient aeration of the hob.

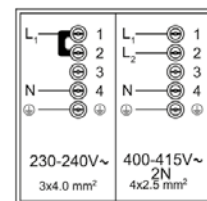
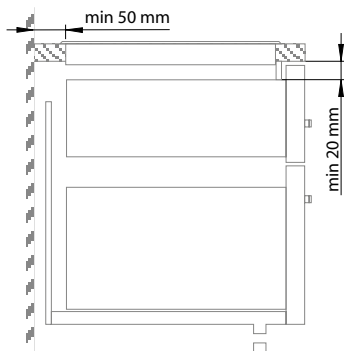

Electrical connection

Many models can be connected with a single and two-phase power. The icons beside show the different possible connections.

Foster Milano Air **NEW**

Foster 

FIRE AND AIR TOGETHER, IN A++ ENERGY CLASS



Six aspiring speeds

Six suction speeds and an airflow up to 750 mc/h guarantee a powerful and effective suction in all situations.



Overspilling water security

The containment bowl under the grid can contain up to 1,5 litres of overspilling.



Smooth surface

The Foster Milan Air hob is perfectly flush, even in the suction area. The whole space is thus available to slide the pots around in perfect safety.



Easy access to filters

The ergonomic shape of the grid allows easy access to clean the filters and the containment bowl.



Double Bridge zone

Foster Milano Air offers two ample cooking zones, which can be extended through the Bridge function.





Intuitive control

The practical touch-control panel manages in an easy and intuitive way both the cooking and the suction function.

Foster Milano Air

Features | Version | Ref. | Technical Drawing

	SF	7391 245
	FT	7391 245

Flat-edge: **860x530** - cut-out: **810x500** mm
 Flush-mount: **860x530** - cut-out: see web site



Available from September 2017

Max power	7.400 W
2 frontal plates	Ø 160 mm - 1.200 (1.600)* W
2 rear plates	Ø 200 mm - 2.300 (3.000)* W
2 extended Bridge zones	3.700 W

* Powerboost



power supply:
 single-phase 230V~1P+N
 two-phase 400V~2P+N
 frequency 50±60 Hz

Induction cooker hob with integrated suction hood

Finish:
 Black glass ceramic

Induction features:
 electronic programming;
 double Bridge function;
 9 power setting per zone plus Powerboost function;
 touch controls; pot detector;
 security lock

Suction features:
 Suction mode;
 Electronic programming;
 6 suction speeds (4+2 intensive modes);
 2 washable grease filters;
 automatic delayed shutdown;
 notice of grease and carbon filters' saturation; optional filtering mode with carbon filters
 Airflow rate: 680 m³/h - EBM Motor
Energy class: A++

Accessories:
 cod. 9700 529 - regenerable carbon filter*

Note:
 air extraction pipe and air evacuation grid for kitchen plinth available on request.

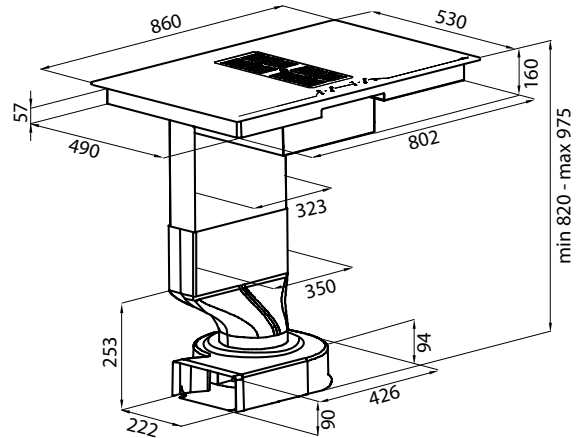

*The charcoal filter is regenerable once with washing in the dishwasher, thereby doubling its duration.



Space saving

The installation of the Foster Milano Air hob is easy and flexible. The shape of the hood leaves ample space under the cabinet, allowing to install two spacious drawers. The motor, which is installed on the ground under the cabinet's floor, can be rotated in order to facilitate the air extraction in the suitable direction.

S4000 Induction Bridge

THE FUNCTIONALITY OF AN EXTENDED COOKING ZONE



	Features	Version	Ref.	Technical Drawing
--	----------	---------	------	-------------------

NEW

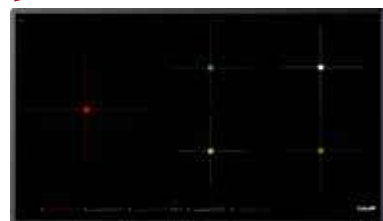

power supply:
single-phase 230V~1P+N
two-phase 400V~2P+N
frequency 50÷60 Hz



Induction cooker hob

Finish:
Black glass ceramic
electronic
programming;
Bridge function;
9 power setting
per zone plus double
Powerboost function;
touch controls;
3 slider commands for
every zone;
T-Chef function;
go&stop device;
pause; recall;
independent timer;
security lock



7390 245

Max power 11.100 W
left Ø 260 mm-2.600 (3.700)* W
sup. center Ø 180 mm-1.850 (3.000)* W
inf. center Ø 145 mm-1.400 (2.200)* W
right: 2x220x180 mm-2.100 (3.700)* W
* Powerboost



Flat-edge: **900x520** - cut-out: **880x490**
Flush-mount: **900x520** - cut-out: see web site

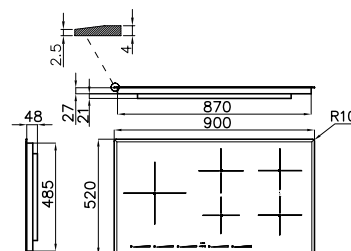

power supply:
single-phase 230V~1P+N
two-phase 400V~2P+N
frequency 50÷60 Hz



Induction cooker hob

Finish:
Black glass ceramic
electronic
programming;
Bridge function;
9 power setting
per zone plus double
Powerboost function;
touch controls;
3 slider commands for
every zone;
T-Chef function;
go&stop device;
pause; recall;
independent timer;
security lock



7330 245

Max power 7.400 W
left Ø 260 mm-2.600 (3.600)* (3.700)** W
center 180x220 mm-2.100 (2.600)* (3.700)** W
right 180x220 mm-2.100 (2.600)* (3.700)** W
* Powerboost - **Double Powerboost



Flat-edge: **840x350** - cut-out: **810x332**
Flush-mount: **840x350** - cut-out: see web site

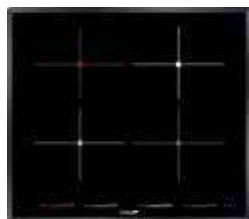
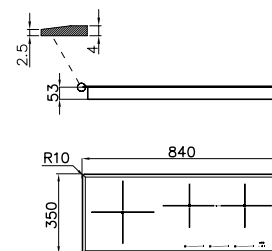

power supply:
single-phase 230V~1P+N
two-phase 400V~2P+N
frequency 50÷60 Hz



Induction cooker hob

Finish:
Black glass ceramic
electronic
programming;
double Bridge function;
9 power setting
per zone plus double
Powerboost function;
touch controls;
4 slider commands for
every zone;
T-Chef function;
go&stop device;
pause; recall;
independent timer;
security lock



7370 245

Max power 7.400 W
left: 2 zones with Bridge function
180x220 mm-2.100 (2.600)* (3.700)** W
right: 2 zones with Bridge function
180x220 mm-2.100 (2.600)* (3.700)** W
* Powerboost - **Double Powerboost



Flat-edge: **590x520** - cut-out: **560x490**
Flush-mount: **590x520** - cut-out: see web site

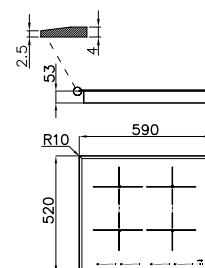

S4000 Induction con Power Control

PERFORMANCE WITH CONTROLLED POWER



← kW →
2,8÷7,2

Features | Version | Ref. | Technical Drawing



NEW

Induction cooker hob



Finish:
Black glass ceramic

7330 241

PowerControl function Max power **6.600** W**
 electronic programming; slider command; touch controls; pause; security lock
 left Ø 240 mm-2.200 (3.000)* W
 center Ø 145 mm-1.200 (1.600)* W
 right Ø 210 mm-1.500 (2.000)* W
 * Powerboost



Flat-edge: **840x350** - cut-out: **810x330**
 Flush-mount: **840x350** - cut-out: see web site

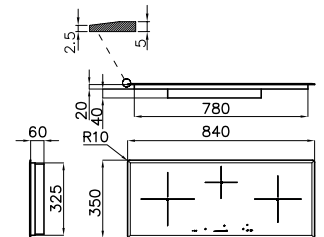

← kW →
2,8÷7,2

power supply:
single-phase 230V~1P+N
two-phase 400V~2P+N
frequency 50÷60 Hz

**thanks to PowerControl function, the max power can be selected among the following values: 2.800 W, 3.500 W, 6.000 W, 6.600 W



← kW →
2,8÷7,2

Induction cooker hob



Finish:
Black glass ceramic

7372 241

PowerControl function Max power **2.800, 3.500, 6.000, 7.200** W**
 electronic programming; 9 power setting per zone plus Powerboost function; touch controls; pause; security lock
 left Ø 210 mm-1.500 (2.000)* W
 left sup. Ø 145 mm-1.200 (1.600)* W
 right Ø 145 mm-1.200 (1.600)* W
 right sup. Ø 210 mm-1.500 (2.000)* W
 * Powerboost



Flat-edge: **590x520** - cut-out: **560x490**
 Flush-mount: **590x520** - cut-out: see web site

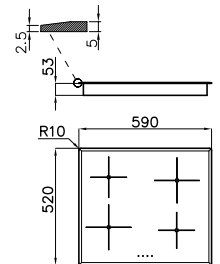

power supply:
single-phase 230V~1P+N
two-phase 400V~2P+N
frequency 50÷60 Hz

**thanks to PowerControl function, the max power can be selected among the following values: 2.800 W, 3.500 W, 6.000 W, 7.200 W

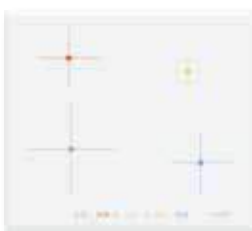

← kW →
2,8÷7,2

Induction cooker hob



Finish:
White glass ceramic

7372 141

PowerControl function Max power **2.800, 3.500, 6.000, 7.200** W**
 electronic programming; 9 power setting per zone plus Powerboost function; touch controls; pause; security lock
 left Ø 210 mm-1.500 (2.000)* W
 left sup. Ø 145 mm-1.200 (1.600)* W
 right Ø 145 mm-1.200 (1.600)* W
 right sup. Ø 210 mm-1.500 (2.000)* W
 * Powerboost



Flat-edge: **590x520** - cut-out: **560x490**
 Flush-mount: **590x520** - cut-out: see web site

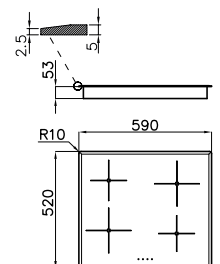

power supply:
single-phase 230V~1P+N
two-phase 400V~2P+N
frequency 50÷60 Hz

**thanks to PowerControl function, the max power can be selected among the following values: 2.800 W, 3.500 W, 6.000 W, 7.200 W

S4000 Induction

STYLE ICON



Features	Version	Ref.	Technical Drawing
----------	---------	------	-------------------



Induction cooker hob

Finish:
Black glass ceramic

power supply:
single-phase 230V~1P+N
two-phase 400V~2P+N
frequency 50÷60 Hz

SF
FT

7334 240

Max power 7.400 W

left	Ø 210 mm-2.050 (2.500)* (3.700)** W
center left	Ø 210 mm-2.050 (2.500)* (3.700)** W
center right	Ø 180 mm-1.850 (2.300)* (3.000)** W
right	Ø 180 mm-1.850 (2.300)* (3.000)** W

* Powerboost - **Double Powerboost



Flat-edge: **1100x350** - cut-out: **1065x325**
Flush-mount: **1100x350** - cut-out: see web site

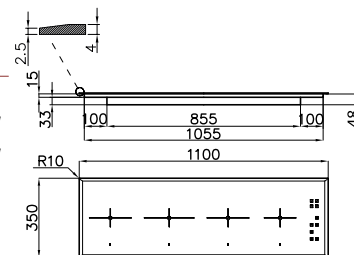

Induction cooker hob

Finish:
Black glass ceramic
electronic programming;
9 power setting per zone plus
Powerboost function;
touch controls;
Slider command;
pause; recall;
temperature maintenance;
independent timer;
security lock

power supply:
single-phase 230V~1P+N
two-phase 400V~2P+N
frequency 50÷60 Hz

Q4
FT

7311 240

Max power 7.400 W

left	Ø 200 mm-2.300 (3.000)* W
center	Ø 160 mm-1.100 (1.400)* W
right	Ø 200 mm-2.300 (3.000)* W

*Powerboost



Q4: **900x450** - cut-out: see web site
Flush-mount: **900x450** - cut-out: see web site

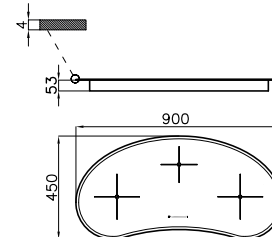

Induction cooker hob

Finish:
Black glass ceramic
electronic programming;
9 power setting per zone plus
Powerboost function;
touch controls;
Slider command;
go&stop device;
pause; recall;
temperature maintenance;
independent timer;
security lock

power supply:
single-phase 230V~1P+N
two-phase 400V~2P+N
frequency 50÷60 Hz

SF
FT

7332 240

Max power 7.400 W

left	Ø 250 mm-2.300 (3.000)* W
center	Ø 180 mm-1.200 (1.400)* W
right	Ø 220 mm-2.300 (3.000)* W
right sup.	Ø 160 mm-1.200 (1.400)* W

* Powerboost





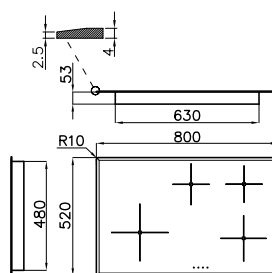



Flat-edge: **800x520** - cut-out: **650x490**
Flush-mount: **800x520** - cut-out: see web site

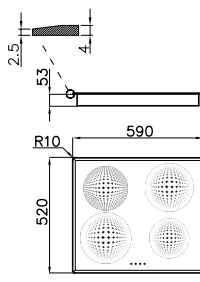
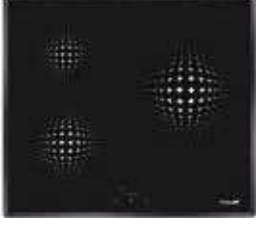

Elettra Induction

INDUCTION OUT OF THE ORDINARY

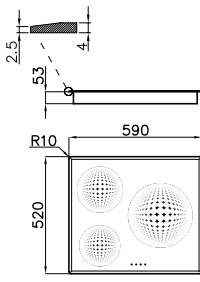

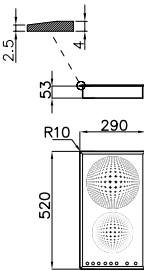



	Features	Version	Ref.	Technical Drawing
 <p>power supply: single-phase 230V~1P+N two-phase 400V~2P+N frequency 50±60 Hz</p>	<p>Induction cooker hob</p> <p>Finish: Black glass ceramic</p> <p>electronic programming; 9 power setting per zone plus Powerboost function; touch controls; independent timer; security lock</p>	<p>SF FT</p> <p>7370 231</p>	<p>Max power 7.100 W</p> <p>left Ø 160 mm - 1.400 (2.000)* W left sup. Ø 160 mm - 1.400 W right Ø 200 mm - 2.300 (3.000)* W right sup. Ø 160 mm - 1.400 W</p> <p>* Powerboost</p> 	<p>Flat-edge: 590x520 - cut-out: 560x490 Flush-mount: 590x520 - cut-out: see web site</p> 
 <p>power supply: single-phase 230V~1P+N two-phase 400V~2P+N frequency 50±60 Hz</p>	<p>Induction cooker hob</p> <p>Finish: Black glass ceramic</p> <p>electronic programming; 9 power setting per zone plus Powerboost function; touch controls; independent timer; security lock</p>	<p>SF FT</p> <p>7331 231</p>	<p>Max power 6.400 W</p> <p>left Ø 160 mm - 1.400 (2.000)* W left sup. Ø 160 mm - 1.400 W right Ø 200 mm - 2.300 (3.000)* W</p> <p>* Powerboost</p> 	<p>Flat-edge: 590x520 - cut-out: 560x490 Flush-mount: 590x520 - cut-out: see web site</p> 
 <p>NEW</p> <p>Available from July 2017</p> <p>power supply: single-phase 230V~1P+N frequency 50±60 Hz</p>	<p>Induction cooker hob</p> <p>Finish: Black glass ceramic</p> <p>electronic programming; 9 power setting per zone plus Powerboost function; touch controls; independent timer; security lock</p>	<p>SF FT</p> <p>7322 234</p>	<p>Max power 3.520 W</p> <p>superior Ø 175 mm - 1.400 W bottom Ø 215 mm - 2.300 (3.000)* W</p> <p>* Powerboost</p> 	<p>Flat-edge: 290x520 - cut-out: 270x500 Flush-mount: 290x520 - cut-out: see web site</p> 

S1000 Induction

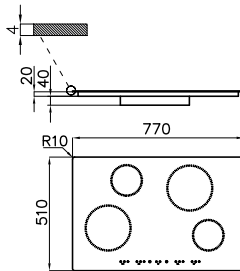
ESSENTIAL DESIGN WITH POWER CONTROL TECHNOLOGY

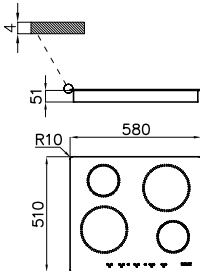

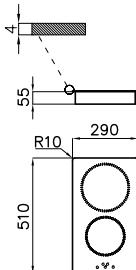





	Features	Version	Ref.	Technical Drawing
 <p>power supply: single-phase 230V~1P+N two-phase 400V~2P+N frequency 50÷60 Hz</p>	Induction cooker hob Black glass PowerControl function electronic programming; 9 power setting per zone plus Powerboost function; touch controls; pause; full safety system	FT Q4	7371 300 Max power 2.800, 3.500, 6.000, 7.200** W left Ø 210 mm-1.500 (2.000)* W left sup. Ø 145 mm-1.200 (1.600)* W right Ø 145 mm-1.200 (1.600)* W right sup. Ø 210 mm-1.500 (2.000)* W * Powerboost	Q4: 770x510 - cut-out: 750x490 Flush-mount: 770x510 - cut-out: see web site 
 <p>power supply: single-phase 230V~1P+N two-phase 400V~2P+N frequency 50÷60 Hz</p>	Induction cooker hob Black glass PowerControl function electronic programming; 9 power setting per zone plus Powerboost function; touch controls; pause; full safety system	FT Q4	7370 300 Max power 2.800, 3.500, 6.000, 7.200** W left Ø 210 mm-1.500 (2.000)* W left sup. Ø 145 mm-1.200 (1.600)* W right Ø 145 mm-1.200 (1.600)* W right sup. Ø 210 mm-1.500 (2.000)* W * Powerboost	Q4: 580x510 - cut-out: 560x490 Flush-mount: 580x510 - cut-out: see web site 
 <p>power supply: single-phase 230V~1P+N frequency 50÷60 Hz</p>	Induction cooker hob Black glass electronic programming; 9 power setting per zone plus Powerboost function; touch controls; full safety system	FT Q4	7322 300 Max power 3.700 W superior Ø 200 mm-2.300 (3.000)* W bottom Ø 160 mm-1.400 W * Powerboost	Q4: 290x510 - cut-out: 270x490 Flush-mount: 290x510 - cut-out: see web site 

S4000 Domino

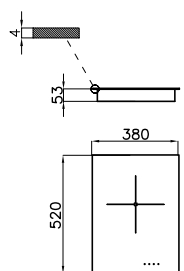
A TAILORED COOKING ZONE

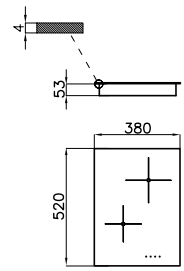
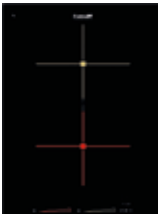

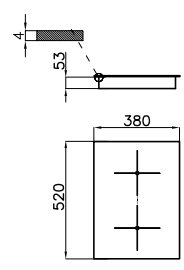
	Features	Version	Ref.	Technical Drawing
 <p>power supply: single-phase 230V~1P+N frequency 50±60 Hz</p>	<p>Induction cooker hob</p> <p>Finish: Black glass ceramic</p> <p>electronic programming; 9 power setting per zone plus Powerboost function; touch controls; independent timer; security lock</p> <p>Accessories: spacer (see page 155)</p>	<p>Q4</p> <p>FT</p>	<p>7321 240</p> <p>Max power 3.000 W</p> <p>cooking zone Ø 250 mm-2.300 (3.000)* W</p> <p>* Powerboost</p> <p></p>	<p>Q4: 380x520 - cut-out: 350x490 Flush-mount: 380x520 - cut-out: see web site</p> 
 <p>power supply: single-phase 230V~1P+N frequency 50±60 Hz</p>	<p>Induction cooker hob</p> <p>Finish: Black glass ceramic</p> <p>electronic programming; 9 power setting per zone plus Powerboost function; touch controls; independent timer; security lock</p> <p>Accessories: spacer (see page 155)</p>	<p>Q4</p> <p>FT</p>	<p>7322 240</p> <p>Max power 3.700 W</p> <p>superior Ø 200 mm-2.300 (3.000)* W bottom Ø 160 mm-1.200 (1.400)* W</p> <p>* Powerboost</p> <p></p>	<p>Q4: 380x520 - cut-out: 350x490 Flush-mount: 380x520 - cut-out: see web site</p> 
 <p>NEW</p>  <p>power supply: single-phase 230V~1P+N frequency 50±60 Hz</p>	<p>Induction cooker hob</p> <p>Finish: Black glass ceramic electronic programming; Bridge function; 9 power setting per zone plus double Powerboost function; touch controls; 2 slider commands for every zone; T-Chef function; pause; recall; independent timer; security lock</p> <p>Accessories: spacer (see page 155)</p>	<p>Q4</p> <p>FT</p>	<p>7341 645</p> <p>Max power 3.700 W</p> <p>2 zones with Bridge function 180x220 mm-2.100 (2.600)* (3.700)** W</p> <p>* Powerboost - **Double Powerboost</p> <p></p>	<p>Flat-edge: 380x520 - cut-out: 350x490 Flush-mount: 380x520 - cut-out: see web site</p> 

S4000 Domino

Features	Version	Ref.	Technical Drawing
----------	---------	------	-------------------



power supply:
single-phase 230V~1P+N
frequency 50÷60 Hz

Induction cooker hob

Finish:
White glass ceramic
electronic
programming;
Bridge function;
9 power setting
per zone plus double
Powerboost function;
touch controls;
2 slider commands for
every zone;
T-Chef function;
pause; recall;
independent timer;
security lock
Accessories: spacer
(see page 155)

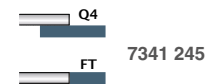

7341 245

Max power 3.700 W
2 zones with Bridge function
180x220 mm-2.100 (2.600)* (3.700)** W

* Powerboost - **Double Powerboost



Flat-edge: 380x520 - cut-out: 350x490
Flush-mount: 380x520 - cut-out: see web site

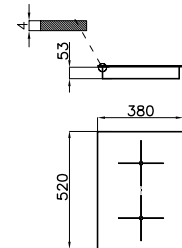

S4000.Domino.Teppan.IS.2



power supply:
single-phase 230V~1P+N
frequency 50÷60 Hz

Induction cooker hob

steel surface;
2 independent cooking
areas A and B;
9 power setting
per zone;
electronic
programming;
touch-control;
2 slider commands;
2 independent timers;
pause;
security lock;
electronic temperature
control from
120° to 220°C
Accessories: spacer
(see page 155)



7325 445

Max power 2.800 W
2 cooking zones
2x1.400 W



Dimension: 380x520 - cut-out: 360x490

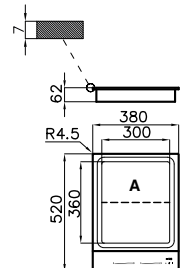

Domino Grill



power supply:
single-phase 230V~1P+N
frequency 50÷60 Hz

Stainless steel AISI
304 brushed base;
cast iron grid;

7 power settings;

supplied with 1,6 Kg
of volcanic stone

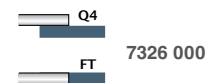

7326 000

Max power 2.500 W

Accessories: spacer
(see page 155)

Q4: 380x520 - cut-out: 360x500
Flush-mount: 380x520 - cut-out: see web site

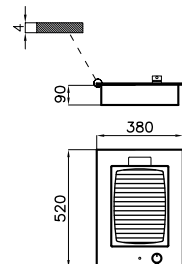

S4000 Domino

Finish	Ref.
Stainless steel	8320 000

Spacer for Domino elements

Stainless steel 8320 000

The stainless steel jointing profile, allows the various Domino elements (vertical edge) to be coupled together with wide distance.

Dimensions:
30x520 mm

Also available in "taylor-made" version (on request), the spacer allows to increase the space between Domino elements, thus creating a practical working surface.



Notice on installation in modular continuous solution

Installation with separate cut-outs

For proper continuous installation a distance of 20 mm among the products cutouts should be maintained (with the exception of a 18 mm distance between the hood and another product). To ensure the vertical alignment of the products we recommend a unique cut-out depth of 500 mm, regardless what is mentioned in the user's manuals (480, 490, 500 mm, depending on model).

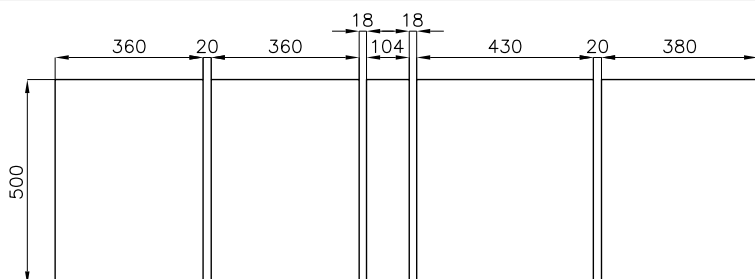
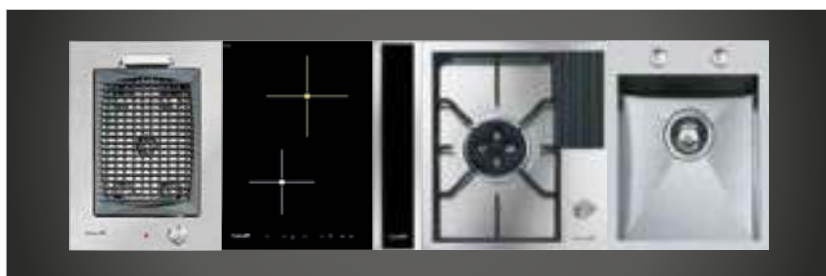

Installation with single cut-out using spacer

By using spacers you can install products in a single cut-out of 500 mm in depth and in length equal to the sum of dimensions of products and spacers, decreased of 20 mm. In the following example, from links: (380 +30 +30 +380 +120 +450 +30 +30 +400) mm-20 mm = 1830 mm

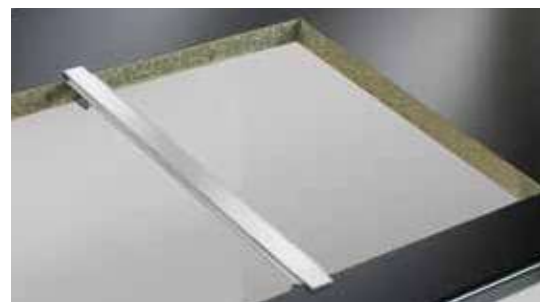
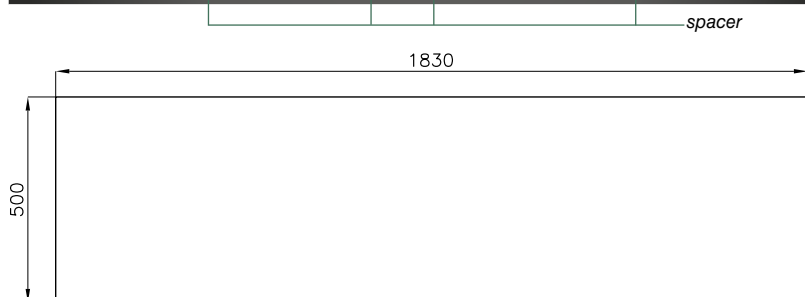
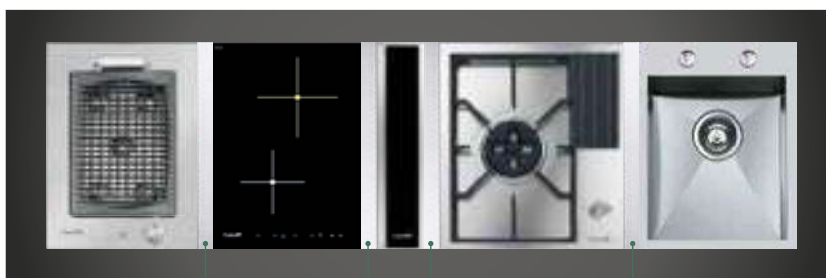

S4000 Domino is configured as a Q4 built-in. However, due to design constraints, some products have a slightly greater thickness. This produces a small step between the products when installed in continuous: Teppan, Wok and hood. For proper evaluation refer to each model drawings which give the exact thickness.

Modular Induction Series

Maximum freedom

Modular Induction is a new Foster proposal that offers full freedom to compose your induction hob according to the available space and your specific needs.

Countless possibilities

The three models of hobs, different for diameter and power, can be positioned with great flexibility in combinations of two, three or four zones controlled by their own touch controls.

Intuitive installation

The installation is quick and easy thanks to the connection box, easy to fit under the worktop, which connects the plates to the touch controls.

Matching to your style

Modular Induction is available in black or white version, for a perfect harmony with your worktop and your kitchen.



Modular Induction Series - touch control module



power supply:
single-phase 230V~1P+N
two-phase 400V~2P+N
frequency 50±60 Hz







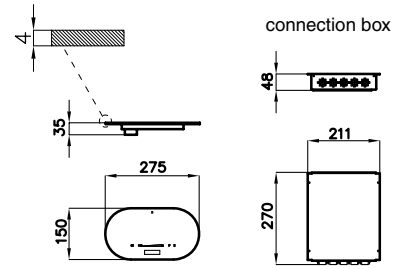

Touch controls module
Slider function;
electronic independent
programming of cooking zones;

to be ordered with matching connection box
Connection cable lenght: 60 cm

Note: the touch control module requires a simple configuration, depending on the combination of plates associated, as indicated in the installation manual.









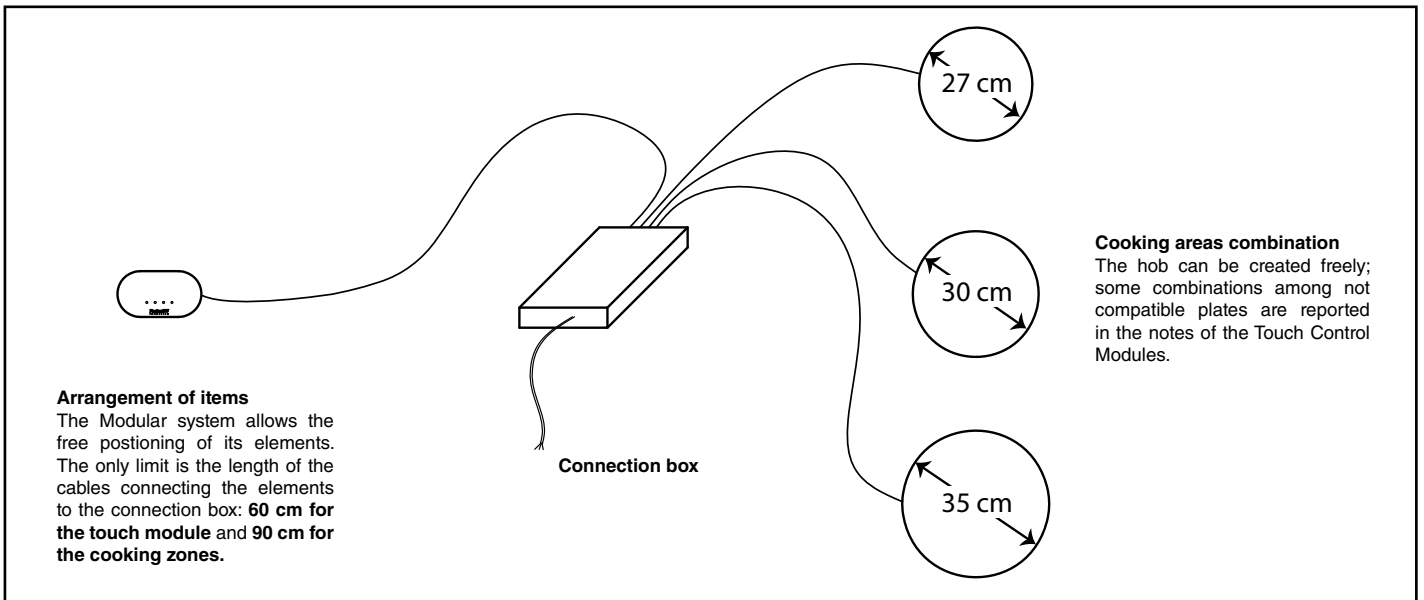



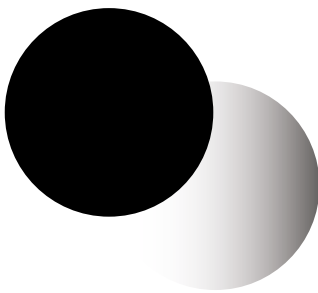

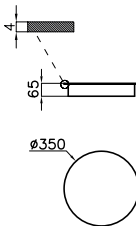
Dimensions: 275x150 mm R75
Flush-mount cut-out: see web site

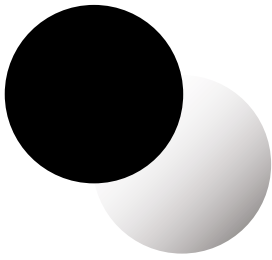
	Version	Ref.	
4 zones touch control 	 black + connection box	7368 040 + 7369 040	Possible zones combinations: - 2 zones 7361 27* - 2 free zones (any model)
	 white + connection box	7368 045 + 7369 040	
3 zones touch control 	 black + connection box	7368 030 + 7369 030	
	 white + connection box	7368 035 + 7369 030	
2 zones touch control 	 black + connection box	7368 020 + 7369 020	Possible zones combinations: - 2 free zones (any model)
	 white + connection box	7368 025 + 7369 020	

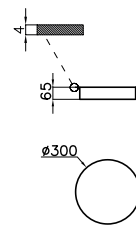
Modular Induction connections

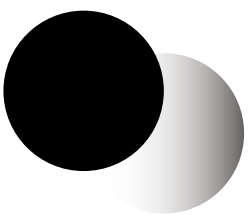

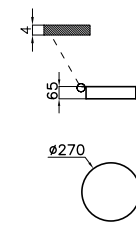
Modular Induction Series - cooking zones

	Features	Version	Ref.	Technical Drawing
Ø 350 induction zones 	 Electronic programming; 9 power setting per zone plus Powerboost function; Slider control; touch control; go&stop device; safety lock Connection cable length: 90 cm	black	7363 350	flush-mount cut-out: see web site 
		white	7363 355	
		Max power	2.300 (3.000)* W	
		* Powerboost		
Ø 300 induction zones 	 Electronic programming; 9 power setting per zone plus Powerboost function; Slider control; touch control; go&stop device; safety lock Connection cable length: 90 cm	black	7362 300	flush-mount cut-out: see web site 
		white	7362 305	
		Max power	2.300 (3.000)* W	
		* Powerboost		
Ø 270 induction zones 	 Electronic programming; 9 power setting per zone plus Powerboost function; Slider control; touch control; go&stop device; safety lock Connection cable length: 90 cm	black	7361 270	flush-mount cut-out: see web site 
		white	7361 275	
		Max power	1.100 (1.400)* W	
		* Powerboost		

Example of composition and how to order it



The component elements of a Modular Induction system must be ordered individually. This allows maximum flexibility in the design phase.







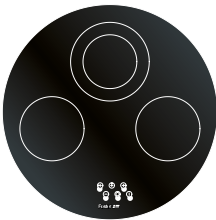

Before you order, we recommend to check the following:

- identify the installation area for the connection box and check that the distances between it and the elements (touch controls and cooking zones) are smaller than the lengths of the connecting cables included;
- verify that the combination of the selected cooking plates is a possible.

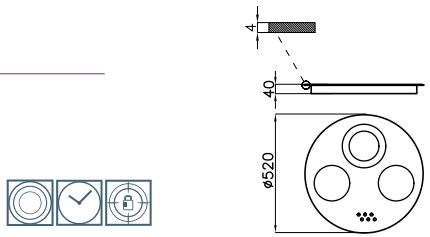
As example, we list below the items to be ordered for the composition of the picture on the left:

- N. 1-7368 030 - black glass 3-zones touch controls
- N. 1-7369 030 - 3-zones connection box
- N. 1-7363 350 - Black glass cooking zone Ø 350 mm
- N. 1-7362 300 - Black glass cooking zone Ø 300
- N. 1-7361 270 - Black glass cooking zone Ø 270 mm

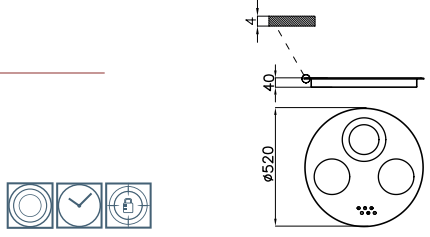
Vitroline Hi-light

	Features	Version	Ref.	Technical Drawing
	<p>Finish: Black glass ceramic</p> <p>multiple zones; security lock; halogen plates high-light; residual heat warning lights; touch controls; 9 power setting per zone; power supply: 220-230 V 50-60 Hz</p>	<p> Q4</p> <p> FT</p>	<p>7316 000</p> <hr/> <p>Max power 4.100 W</p> <p>left Ø 140 mm-1.200 W</p> <p>center Ø 180 mm-700/1.700 W</p> <p>right Ø 140 mm-1.200 W</p>	<p>Q4: Ø 520 - cut-out: Ø 500 Flush-mount: Ø 520 - cut-out: see web site</p>  
	<p>Finish: White glass ceramic</p> <p>multiple zones; security lock; halogen plates high-light; residual heat warning lights; touch controls; 9 power setting per zone; power supply: 220-230 V 50-60 Hz</p>	<p> Q4</p> <p> FT</p>	<p>7316 100</p> <hr/> <p>Max power 4.100 W</p> <p>left Ø 140 mm-1.200 W</p> <p>center Ø 180 mm-700/1.700 W</p> <p>right Ø 140 mm-1.200 W</p>	<p>Q4: Ø 520 - cut-out: Ø 500 Flush-mount: Ø 520 - cut-out: see web site</p>  

Induction PRO Pots collection

TOP PERFORMANCE FOR YOUR INDUCTION



Set of Induction PRO pots, 8 pcs



Ref.
8210 008

In 18/10 stainless steel
Triple bottom steel/aluminium /steel,
thermo-welding with Impact Bonding technology.
Professional handles with 6 welding spots
Washable in dishwasher

- 1 Pot Ø cm 24
- 1 Deep casserole Ø cm 20
- 1 Deep casserole Ø cm 24
- 1 Saucepan Ø cm 16
- 1 Pan Ø cm 24
- 1 Milkpot Ø cm 12
- 1 Glass lid Ø cm 20
- 1 Glass lid Ø cm 24

Induction PRO Wok pan with flat bottom



Ref.
8211 000

In 18/10 stainless steel - Ø 30 cm
Triple bottom steel/aluminium /steel,
thermo-welding with Impact Bonding technology.
Washable in dishwasher

Induction PRO steak-pan



Ref.
8212 000

in aluminium, Teflon coated DuPont Platinum plus
Aluminium-steel thermo-fused bottom - 30x30 cm
Bakelite handle
Washable in dishwasher

Induction PRO Moka coffee-maker



























Ref.
8213 000

In 18/10 stainless steel
Adapter for 2-4 cups



Ovens, Microwave, Blast chiller and Coffee Machine

A complete range of modern, efficient household appliances: from FL, KS, KE and Milano maxi ovens with their 90 cm width to the practical dimensions of the Elettra Compact oven - barely 36 cm high - the ideal solution for any space-related need is always on hand. Foster offers modular products that allow for creating coordinated design solutions by combining multifunctional ovens with microwave+grill ovens, with multifunctional ovens including the steam cooking system, or even with multifunctional ovens with pyrolysis self-cleaning (models with 46 cm and 60 cm height and maximum capacity of up to 72 litres).

S4000 ovens p. 166		FL Combi Steam p. 171		KE Micro-Combi p. 176	
S4000 Combi Steam p. 167		FL Coffee Machine p. 172		KE Compact p. 177	
S4000 Micro-Grill p. 167		FL Plate-warmer module p. 172		KE 90 oven p. 177	
S4000 Plate-warmer module p. 167		FL Blast chiller p. 173		FL Plate-warmer p. 177	
Coffee Machine S4000 p. 168		FL Vintage ovens p. 174		KS ovens p. 178	
FL One Touch oven p. 169		FL Vintage Micro Combi p. 174		Stripe oven p. 179	
FL ovens p. 170		Milano ovens p. 175		Elettra Compact p. 180	
FL Micro Combi p. 171		KE ovens p. 176		S1000 Micro p. 180	

Features



Easy-Clean enamelling

The Easy-Clean enamelling makes the internal oven surfaces and accessories non-adhesive, while the limited porosity ensures durability and easy cleaning.



Soft-closing door

In the FL One Touch oven every detail is taken care of. The door's hinges automatically slow down in the final part of their movement, to achieve a delicate and silent closing.



Totally or partially extractable telescopic guides

Most of Foster ovens feature telescopic guides on three levels which improve space distribution and ensure easy and safe extraction of grids and pans.



Stop Sol glass

The special screening and mirroring treatment of external glass gives the oven an elegant and modern aesthetic. The oven remains dark when not in use, once the illumination is switched on, the inside is perfectly visible.



Cooking chamber capacity

With a cooking chamber capacity of 72 litres and 6 different cooking levels, Foster ovens top their category for guaranteed capacity featured on a 60x60 cm built-in oven.

XL means that those models feature a capacity exceeding 60 litres.



Modularity

The range of ovens with 46 cm height adds to the traditional 60 cm size with the dual purpose of solving space-related problems and configuring various combinations. The Elettra solutions are ideal for installation in small spaces, while the 90 cm-wide Milano, FL, KE and KS ovens are the perfect solution for kitchens without any space constraints.



Heat probe

It records the temperature at the core of the product at all times. Once the cooking temperature has been set, the oven signals when the core of the food has reached it, and deactivates the heating elements.



Self-Cooking

Thanks to the extensive recipe menu made available by Self-Cooking technology and the food temperature control by Heat probe (where available), you can turn into a good cook in a short time. Those who are already expert cooks can create their personal cook book by memorizing the recipes in the oven.

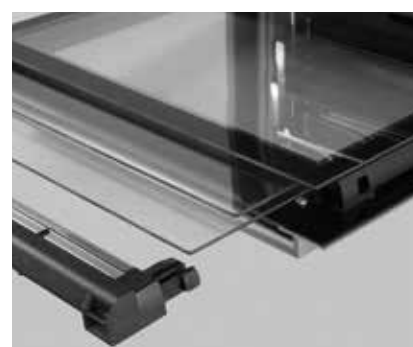

Removable glasses

The glass of the door of the oven can be removed for complete cleaning. In the picture the system of KE oven: the glass can be removed with a simple "click".

Features



Self-cleaning pyrolysis

An efficient, automatic cleaning system that guarantees oven cleanliness and saves our time.



Periodically the Pyrolysis self-cleaning can be activated with 3 possible programs, according to the oven degree of dirt.

As soon as you press the Pyrolysis button, the oven door locks and the cooking chamber heats to almost 500°C reducing any cooking residue to fine ash.



Once the self-cleaning cycle has finished, all you have to do is use a damp cloth or sponge to remove the layer of fine ash; no detergent required.



Foster offers an oven range entirely in **A Class**. An important result which proves the high quality, targeted to optimize performance and savings.



Anti-touch finish

The new ovens are offered with the innovative anti-touch finish which, thanks to its special protection, safeguards the steel surfaces from the annoying fingerprints.



Triple glass door

All Foster ovens are equipped with a multiple glass door (up to 3 glasses, 4 for the pyrolytic models). This device ensures low temperatures of external surfaces and lower heat loss.



Full-Glass door

In many models the inside of the oven door constitutes a single smooth glass surface making it practical for cleaning purposes.



Fast preheating

This function turns on the heating elements and a flow of hot air raises the temperature to 200°C within a very short time.



Thermal insulation and tangential fan

The muffle is carefully designed to provide the appliance's supporting structure with a high degree of insulation. The tangential ventilation, featured in all models, creates a flow of air between the muffle and framework, thereby reducing the temperature of the external surfaces. As consequence, the oven does not expose furniture to temperature shock.

Ovens accessories



Pyrex Tray with grid

The pyrex baking dish with its steel grid, is a useful accessory for each preparation, also ideal as a serving dish.



Refractory plate

Plate in refractory material with high heat capacity giving a natural cooking process. Pizzas and focacce cook just like in a wooden oven.

	Ref.	Description
1	9401 549	pyrex tray
3	9401 187	stainless steel grid for pyrex tray

	Ref.	Dimensions
2a	8801 000	35x35x2 cm
2b	9401 506	57x35,5x1,5 cm



Self-cleaning catalytic panels



















Thanks to their special enamel-finish surfaces, these panels facilitate the spontaneous elimination of any residue spattered during usual cooking at around 200°C (392° F).

	Ref.	Description
4a	8800 016	3 Kit panels 63 lt ovens
4c	8800 012	Kit of self-cleaning oven side panels (2 pcs) for Milano 90 cm oven

Multifunctional ovens cooking functions

The wide range of available programs allows Foster ovens to be performing in any situation: from delicate pastry cooking to the meat or pizza intensive ones.



- | | |
|---|--|
|  <p>Lower-level cooking
Suitable for heating foodstuffs.</p> |  <p>Central grill
Ideal for toasting or cooking small portions au gratin.</p> |
|  <p>Upper-level cooking
Suitable for cooking particularly delicate foodstuffs and for keeping them warm after cooking</p> |  <p>Double grill
Heat is generated by the upper grill only: ideal for toasting, cooking au gratin and browning foodstuffs and also suitable for meat, fish and pasta.</p> |
|  <p>Traditional cooking
The ideal function for all traditional recipes, including bread, cakes and roasts.</p> |  <p>Lower-level cooking + grill
To complete static cooking and to cook au gratin simultaneously.</p> |
|  <p>Ventilated cooking
The combination of ventilation and circular heating elements allows for cooking different types of foodstuffs together, without mixing aromas and flavours.</p> |  <p>Lower-level cooking + double grill
To complete the static cooking giving the right crispiness to preparations.</p> |
|  <p>Intensive cooking
The upper and lower heating elements and the fan ensure rapid, uniform cooking. Ideal for cooking pizzas, roasts, lasagne and savoury pies.</p> |  <p>Fan + grill
The combined action of the fan and grill produces rapid and thorough cooking of thick foodstuffs.</p> |
|  <p>Energy saving
Programme that ensures limited energy consumption, ideal for heating foodstuffs or for foodstuffs that require delicate, gradual cooking.</p> |  <p>Fan + double grill
For the final stages of cooking of foods such as roasts and poultry, to give the surfaces the right browning.</p> |
|  <p>Fast preheating
This function turns on the heating elements and a flow of hot air raises the temperature to 200°C within a very short time.</p> |  <p>Thawing
Allows for thawing foodstuffs in one-third of the normal time through uniform distribution of the air at ambient temperature.</p> |
|  <p>Keep warm
Ideal to keep at the right temperature before serving.</p> |  <p>Pizza function
The combination of lower-level, ventilated and grill cooking allows for obtaining a crisp, optimally done pizza.</p> |
|  <p>Low temperatures
Program for a slow and gentle cooking at contained temperatures.</p> |  <p>Grill+Spit
The grill and spit combination produces perfect browning of foodstuffs.</p> |

Gas ovens cooking functions

- | | |
|--|---|
|  <p>Gas ventilated cooking
The combination of ventilation and heat from the bottom burner allows good performances and uniform cooking.</p> |  <p>Gas grill
Heat is generated by a second gas burner on the upper level, functioning without ventilation: ideal for toasting, cooking au gratin and browning foodstuffs and also suitable for meat, fish and pasta.</p> |
|--|---|

Steam ovens cooking functions



The Foster range features two different steam ovens with different characteristics, to meet different needs.

S4000 combi steam oven is a top-class product of excellent performances and great flexibility. It can be considered as a **gastronomic oven** thanks to a sophisticated technology deriving from professional solutions. Steam cooking is combined with convection and creates a complete set of programs ensuring excellent results for all dishes

The new FL solution is a classic steam oven, it features a controlled generation of steam in external boiler, to guarantee perfect results, short heating times and large autonomy of water.



Steam cooking

Particularly recommended for cooking vegetables. Preserves all the foodstuffs' nutritional properties.



Convection cooking

A cooking system that implements hot air.



Food warmer

Suitable for simultaneously warming up multiple foodstuffs in a practical, rapid and cost-efficient way.



Convection + steam

Mixed system that combines the flow of warm air with vapour for obtaining tasty dishes.



Professional cooking

Ideal for all foodstuffs subject to leavening, thanks to the two cooking phases.



Delicate cooking

Ideal for slow cooking of meat, thanks to the temperature controlled by a heat probe.

Microwave oven cooking functions



Four different microwave solutions. **The exclusive S4000** is characterized by many programming options and a clean appearance, perfectly matched to the multifunction and steam ovens of the Series. The **new FL and KE** are complete ovens, which add to microwaves and grill also convection cooking, making it possible an incredible set of cooking programs. So much convenience for **S1000 micro+grill**, perfectly matched to the many steel ovens.



Microwave oven cooking

Ideal for cooking or rapidly heating vegetables, rice, fish, meat and liquids. Different power levels are available.



Grill

For rapidly crusting the surface of foodstuffs. Moreover, the Crunch plate provided creates a crusty layer even on the underside of foodstuffs.



Fan plus grill

The combined action of the fan and grill allows a fast and deep cooking, effective for foods of large volume.



Micro+grill cooking

A combined cooking method that is ideal for lasagne, potatoes, roasts and pies.



Convection cooking

The combination of ventilation and circular heating element generates a uniform heat for a effective and homogeneous cooking.



Convection microwave

The movement of air generated by the fan ensures better homogeneity of micro cooking.



Automatic thawing

Allows for thawing foodstuffs by setting the latter's weight and type.











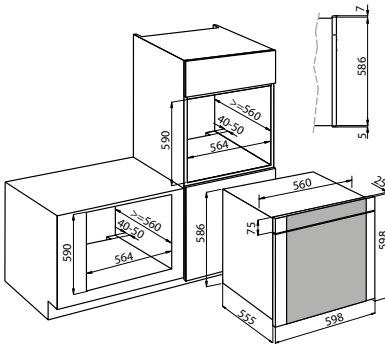

































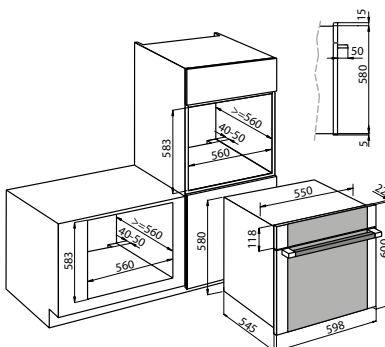























Pre-set programmes











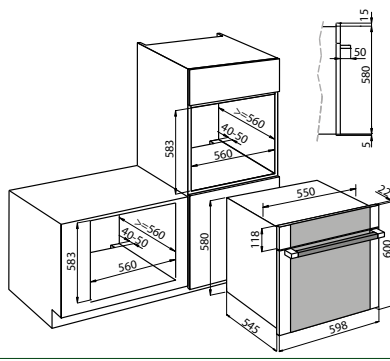

A series of programmes can be selected for heating, cooking, thawing or cooking several types of foodstuffs.

S4000

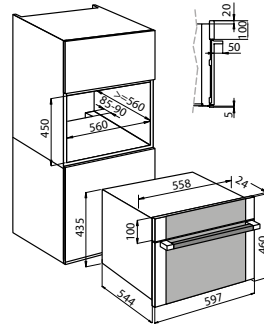

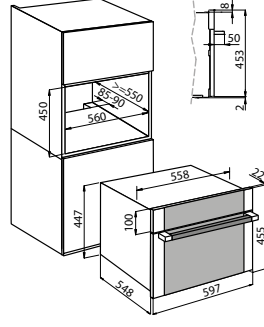
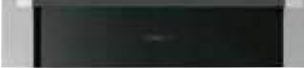

Model	Finish	Ref.	Technical Drawing																				
4000 Series multifunctional PL 60x60 - 72 litres	brushed anti-touch 	7134 043																					
	 <p> • Multifunctional oven 60x60 cm, 72 litres capacity • 10 cooking functions • 6 cooking levels • Reversible side-opening door (PL) • Touch Control opening • Touch controls • Display with intuitive electronic programming • Automatic cooking with programmed recipes • Heat probe for temperature control • 10 customizable recipes • Fast-preheating function • Cooling system with tangential ventilation • 3 fully extractable telescopic guides • Door: 3-glazed • StopSol glass • Full-Glass door • Removable door glasses • Easy-Clean enamelling • Protection for grill heating element • Safety shut-off • Anti-touch finish • Independent inside light • Energy class: A • Power supply: 220-240 V 50-60 Hz Standard accessories: 2 EasyClean enamelled trays - 1 stainless steel grid Accessories: 2a (see page 163) </p>																						
 Reversible door opening with touch-control display (no handle)	<table border="1"> <tr> <th>BOTTOM COOKING</th> <th>TRADIT. COOKING</th> <th>FANNED COOKING</th> <th>FANNED + GRILL</th> <th>ENERGY SAVING</th> <th>INTENSIVE COOKING</th> <th>DOUBLE GRILL</th> <th>CENTRAL GRILL</th> <th>DEFROSTING</th> <th>PIZZA FUNCTION</th> </tr> <tr> <td></td> <td></td> <td></td> <td></td> <td></td> <td></td> <td></td> <td></td> <td></td> <td></td> </tr> </table>	BOTTOM COOKING	TRADIT. COOKING	FANNED COOKING	FANNED + GRILL	ENERGY SAVING	INTENSIVE COOKING	DOUBLE GRILL	CENTRAL GRILL	DEFROSTING	PIZZA FUNCTION												
BOTTOM COOKING	TRADIT. COOKING	FANNED COOKING	FANNED + GRILL	ENERGY SAVING	INTENSIVE COOKING	DOUBLE GRILL	CENTRAL GRILL	DEFROSTING	PIZZA FUNCTION														
																							
4000 Series multifunctional pyrolytic 60x60 - 63 litres	brushed anti-touch 	7139 043																					
	 <p> • Pyrolytic oven 60x60 cm, 63 litres capacity • 10 cooking functions • Pyrolysis self-cleaning • Touch controls • Display with intuitive electronic programming • Automatic cooking with programmed recipes • 10 customizable recipes • Fast-preheating function • Cooling system with tangential ventilation • Door: 4-glazed • StopSol glass • Full-Glass door • Removable door glasses • Pyrolytic enamelling • Protection for grill heating element • Safety shut-off • Door lock during pyrolysis • Independent inside light • Anti-touch finish • Energy class: A • Power supply: 220-240 V, 50-60 Hz Standard accessories: 2 EasyClean enamelled trays - 1 stainless steel grid Accessories: 1-2a (see page 163) </p>																						
	<table border="1"> <tr> <th>BOTTOM COOKING</th> <th>TRADIT. COOKING</th> <th>FANNED COOKING</th> <th>FANNED + GRILL</th> <th>ENERGY SAVING</th> <th>INTENSIVE COOKING</th> <th>DOUBLE GRILL</th> <th>CENTRAL GRILL</th> <th>DEFROSTING</th> <th>PIZZA FUNCTION</th> </tr> <tr> <td></td> <td></td> <td></td> <td></td> <td></td> <td></td> <td></td> <td></td> <td></td> <td></td> </tr> </table>	BOTTOM COOKING	TRADIT. COOKING	FANNED COOKING	FANNED + GRILL	ENERGY SAVING	INTENSIVE COOKING	DOUBLE GRILL	CENTRAL GRILL	DEFROSTING	PIZZA FUNCTION												
BOTTOM COOKING	TRADIT. COOKING	FANNED COOKING	FANNED + GRILL	ENERGY SAVING	INTENSIVE COOKING	DOUBLE GRILL	CENTRAL GRILL	DEFROSTING	PIZZA FUNCTION														
																							

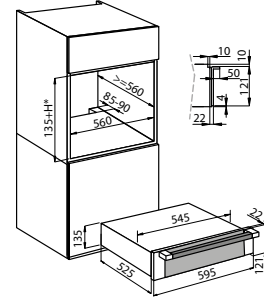
S4000

Model	Finish	Ref.	Technical Drawing
<p>4000 Series multifunctional 60x60 - 63 litres</p> 	<p>brushed anti-touch </p>	<p>7131 053</p>  <p>• Multifunctional oven 60x60 cm, 63 litres capacity • 10 cooking functions • Touch controls • Display with intuitive electronic programming • Automatic cooking with programmed recipes • Heat probe for temperature control • 10 customizable recipes • Fast-preheating function • Cooling system with tangential ventilation • 3 fully extractable telescopic guides • Door: 3-glazed • StopSol glass • Full-Glass door • Removable door glasses • Easy-Clean enamelling • Protection for grill heating element • Safety shut-off • Anti-touch finish • Independent inside light • Energy class: A • Power supply: 220-240 V 50-60 Hz Standard accessories: 2 EasyClean enamelled trays - 1 stainless steel grid Accessories: 2a-4a (see page 163)</p>	
<p>4000 Series combined steam 60x46 - 26 litres</p> 	<p>brushed anti-touch </p>	<p>7135 080*</p>  <p>• Combined steam oven 60x46 cm, 26 litres capacity • 6 cooking functions • Touch controls • Display with intuitive electronic programming • Automatic cooking with programmed recipes • Heat probe for temperature control • 10 customizable recipes • Cooling system with tangential ventilation • Door: 3-glazed • StopSol glass • Full-Glass door • Stainless steel cooking chamber • Safety shut-off • Anti-touch finish • Independent inside light • Energy class: A • Power supply: 220-240 V 50-60 Hz Standard accessories: 1 tray - 1 perforated tray - 1 stainless steel grid</p>	
<p>* Available until stock exhaustion</p>			
<p>4000 Series micro+grill 60x46 - 32 litres</p> 	<p>brushed anti-touch </p>	<p>7136 020</p>  <p>• Micro+grill 60x46, 32 litres capacity • 5 cooking functions • 6 power settings: 200-400-600-800-1000 W (1500 W Grill) • Touch controls • Display with intuitive electronic programming • Automatic defrosting by time and weight • 3 customizable cooking functions • Cooling system with tangential ventilation • StopSol glass • Full-Glass door • Stainless steel cooking chamber • Anti-touch finish • Power supply: 220-240 V 50 Hz Standard accessories: 1 Integrated rotating plate Ø 32 cm - 1 Crunch plate - 2 grids at different heights</p>	
<p>4000 Series plate-warmer module - 60x14</p> 	<p>brushed anti-touch </p>	<p>7138 000</p> <p>• Module 60x14 cm • Slide-out drawer • Stainless steel chamber • Max temperature: 85°C • Suitable to warm and maintain the temperature of food • Maximum load 25 kg • Power supply: 220-240 V 50-60 Hz</p>	<p>Cut-out: 560x(135 mm + H oven cut-out)</p> 

S4000 Coffee Machine

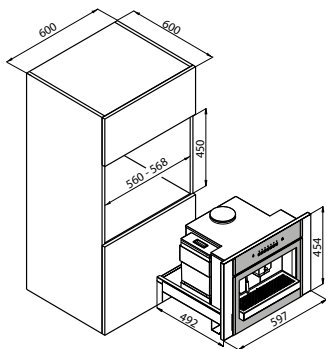

Model	Finish	Ref.	Technical Drawing
<p>Serie 4000 coffee machine</p> 	<p>brushed anti-touch </p>	<p>2999 000</p> <ul style="list-style-type: none"> • AISI 304 Anti-touch finish • Automatic functioning • Coffee supply in beans • Adjustable grinding (10 levels) • Warm water and steam supply • Adjustable strength and size of coffee • 2,5 liter water tank with descaling filter • LED lighting • Low water level indicator • Cleaning funds warning light 	



Detail of the fine LED lighting of the S4000 Coffee machine.



S4000 Coffee machine has a simple and effective drawer opening, which makes it easy to load the coffee beans and water, and to clean out the coffee grounds.



The telescopic system of the dispenser allows the use of different coffee cups and glasses.

The perfect matching between S4000 ovens and coffee machine, further enriched by the addition of plate-warmer units, which are particularly useful both for food preparations and in the rite of preparing a high-quality coffee.



FL One Touch



Visual touch

The latest-generation **visual touch** system offers a complete, simple and intuitive programming for those who have limited experience, while permitting precise and sophisticated control for a professional use of the oven.



Self Cooking

The **AUTO** mode offers a wide menu of recipes, rendered even more intuitive by the pictures of the dishes. The programming has step-by-step suggestions and permits ample personalization of weight, preferences, level of cooking and delayed start, in order to finish cooking with perfect timing.



Multi Step

In **PRO** mode, programming is completely manual, granting full freedom of setting. The MultiStep function helps to create complex cooking cycles, with multiple settings following one-another to grant highly professional results.



My recipes

Every cooking setting, be it manually set or deriving from a personalization of a pre-programmed recipe, can be saved in the personal recipes' book and organized with names and folders.



Special functions











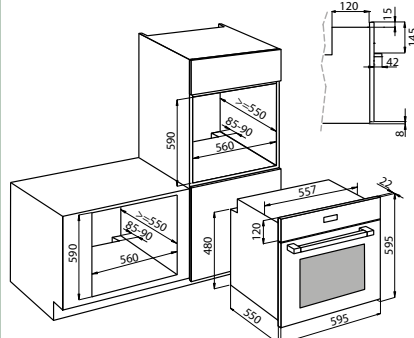







































Several special functions are available next to the customizable cooking programs, such as quick pre-heating, hydrolytic cleaning cycle and keep-warm function for food and crockery.



Heat probe

With the probe inserted, the One Touch oven continuously monitors the temperature of both cooking chamber and the heart of the food.

FL One Touch

Model	Finish	Ref.	Technical Drawing																												
Serie FL One Touch multifunctional 60x60 - 67 litres 	BLACK MIRROR	7106 643																													
<div style="display: flex; justify-content: space-between;"> <div style="width: 20%;">        </div> <div style="width: 60%;"> <ul style="list-style-type: none"> • Multifunctional oven 60x60 cm, 67 litres capacity • 9 cooking programs + 5 special functions • Max temperature 275 °C • One-Touch control display • Intuitive electronic programming Self Cooking Plus • Large cookbook settable for weight and cooking level • Storable personal cookbook • Professional MultiStep programming • Heat probe for temperature control • Fast pre-heating function • Heat maintenance function • AcquaClean function • Collapsible double grill • 3 fully extractable telescopic guides • Door: 3-glazed • Full-Glass door • Removable door glasses • Soft Closing door • Chromed handle • Catalytic rear panel • Easy-Clean enamelling • Protection for grill heating element • Cooling system with tangential ventilation • Asymmetric double halogen light • Mechanical door lock safety • Keyboard lock • Dynamic plus cooling system • Customizable display texts in 4 colors • Programming available in 30 languages • Energy class A • Power supply: 220-240V 50-60Hz <p>Standard equipment: low baking tray - deep drip tray - glass drip tray - Stainless steel grid and trays handle.</p> <p>Accessories: 2a (see page 163)</p> </div> <div style="width: 15%;"></div> </div>																															
<table border="1" style="width: 100%; text-align: center;"> <tr> <td>UPPER COOKING</td> <td>BOTTOM COOKING</td> <td>TRADIT. COOKING</td> <td>FANNED COOKING</td> <td>CENTRAL GRILL</td> <td>DOUBLE GRILL</td> <td>FAN + DOUBLE GRILL</td> <td>BOTTOM-FANNED COOKING</td> <td>BOTTOM COOK + FAN</td> <td>HEAT MAINTENANCE</td> <td>DEFROST</td> <td>WARMER PLATES</td> <td>QUICK HEATING</td> <td>ACQUACLEAN</td> </tr> <tr> <td></td> <td></td> <td></td> <td></td> <td></td> <td></td> <td></td> <td></td> <td></td> <td></td> <td></td> <td></td> <td></td> <td></td> </tr> </table>				UPPER COOKING	BOTTOM COOKING	TRADIT. COOKING	FANNED COOKING	CENTRAL GRILL	DOUBLE GRILL	FAN + DOUBLE GRILL	BOTTOM-FANNED COOKING	BOTTOM COOK + FAN	HEAT MAINTENANCE	DEFROST	WARMER PLATES	QUICK HEATING	ACQUACLEAN														
UPPER COOKING	BOTTOM COOKING	TRADIT. COOKING	FANNED COOKING	CENTRAL GRILL	DOUBLE GRILL	FAN + DOUBLE GRILL	BOTTOM-FANNED COOKING	BOTTOM COOK + FAN	HEAT MAINTENANCE	DEFROST	WARMER PLATES	QUICK HEATING	ACQUACLEAN																		
																															

FL

Model	Finish	Ref.	Technical Drawing
-------	--------	------	-------------------

FL White series

multifunctional 60x60 - 65 litres



WHITE 7105 142

A
XL





- Multifunctional oven 60x60 cm, 65 litres capacity • 14 cooking functions • 17 automatic cooking programs • touch control display • intuitive electronic programming • Heat probe for temperature control • Fast pre-heating function • Collapsible double grill • 2 fully extractable telescopic guides • Door: 3-glazed • Full-Glass door • Removable door glasses • Chromed handle • Easy-Clean enamelling • Protection for grill heating element • Cooling system with tangential ventilation • Asymmetric double halogen light, light-on at door opening • Door contact switch • Safety shut-off • Energy class: A • Power supply: 220-240V 50-60Hz
- Standard accessories: 1 tray (code 9401 539) and 1 drip tray XXL (code 9401 538), stainless steel grid and trays handle
- Accessories: 2a (see page 163)**

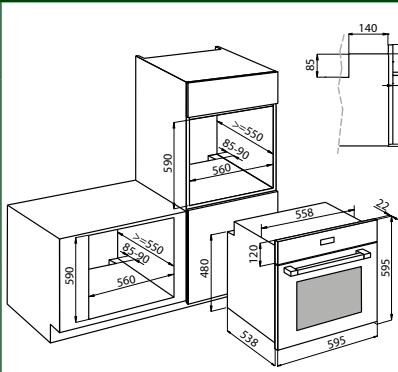

UPPER COOKING	BOTTOM COOKING	TRADIT. COOKING	INTENSIVE COOKING	FANNED COOKING	PIZZA FUNCTION	CENTRAL GRILL	DOUBLE GRILL	BOTTOM COOK. + GRILL	BOTTOM COOK. + DOUBLE GRILL	FANNED + MAXI GRILL	FANNED + GRILL	LOW TEMPERATURE MAINTENANCE	HEAT TEMPERATURE MAINTENANCE
													

FL Black Mirror series

multifunctional 60x60 - 65 litres



BLACK MIRROR 7105 642

A
XL





- Multifunctional oven 60x60 cm, 65 litres capacity • 14 cooking functions • 17 automatic cooking programs • Touch control display • intuitive electronic programming • Heat probe for temperature control • Fast pre-heating function • Collapsible double grill • 2 fully extractable telescopic guides • Door: 3-glazed • Full-Glass door • Removable door glasses • Chromed handle • StopSol glass • Easy-Clean enamelling • Protection for grill heating element • Cooling system with tangential ventilation • Asymmetric double halogen light, light-on at door opening • Door contact switch • Safety shut-off • Energy class: A • Power supply: 220-240V 50-60Hz
- Standard accessories: 1 tray (code 9401 539) and 1 drip tray XXL (code 9401 538), stainless steel grid and trays handle
- Accessories: 2a (see page 163)**

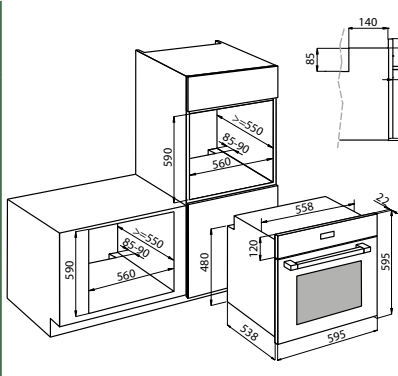



UPPER COOKING	BOTTOM COOKING	TRADIT. COOKING	INTENSIVE COOKING	FANNED COOKING	PIZZA FUNCTION	CENTRAL GRILL	DOUBLE GRILL	BOTTOM COOK. + GRILL	BOTTOM COOK. + DOUBLE GRILL	FANNED + MAXI GRILL	FANNED + GRILL	LOW TEMPERATURE MAINTENANCE	HEAT TEMPERATURE MAINTENANCE
													

FL White - 90

multifunctional 90x48 - 91 litres



WHITE 7107 142

A
XL

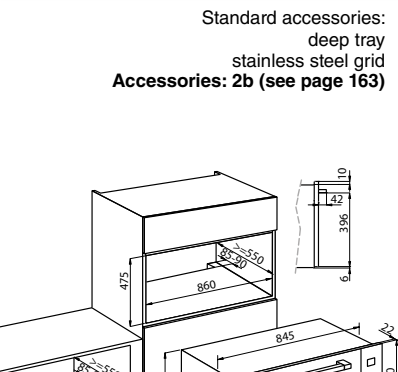

- Multifunctional oven 90x48 cm, 91 litres capacity • 9 cooking functions • Electronic programming of start-end of cooking • Retractable selection knobs • Collapsible double grill • 2 telescopic guides • Door: 3-glazed • Chromed handle • Full-Glass door • Removable door glasses • Easy-Clean enamelling • Protection for grill heating element • Cooling system with tangential ventilation • Asymmetric double halogen light, light-on at door opening • Door contact switch • Energy class: A • Power supply: 220-240V 50-60Hz







BOTTOM COOKING	TRADIT. COOKING	INTENSIVE COOKING	FANNED COOKING	CENTRAL GRILL	DOUBLE GRILL	BOTTOM COOK. + GRILL	FANNED + MAXI GRILL	FANNED + BOTTOM COOK.
								

FL Black Mirror - 90

multifunctional 90x48 - 91 litres



BLACK MIRROR 7107 642





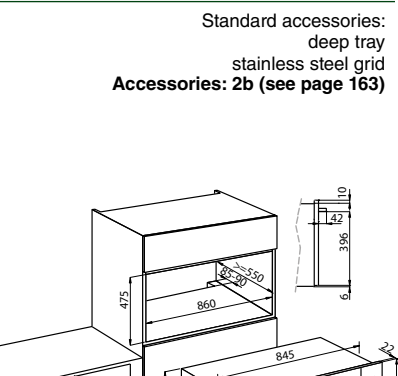

A
XL



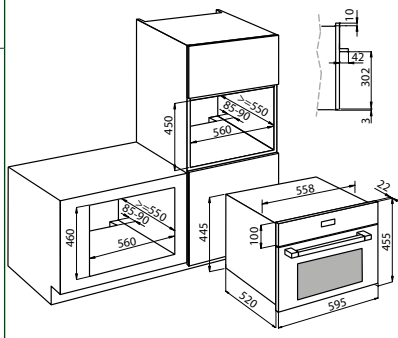

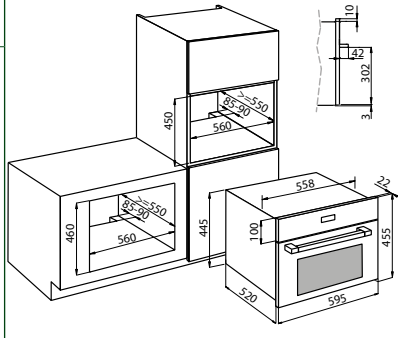
- Multifunctional oven 90x48 cm, 91 litres capacity • 9 cooking functions • Display con programmazione elettronica di inizio-fine cottura e Retractable selection knobs • Collapsible double grill • 2 telescopic guides • Door: 3-glazed • Chromed handle • Full-Glass door • StopSol glass • Removable door glasses • Easy-Clean enamelling • Protection for grill heating element • Cooling system with tangential ventilation • Asymmetric double halogen light, light-on at door opening • Door contact switch • Energy class: A • Power supply: 220-240V 50-60Hz

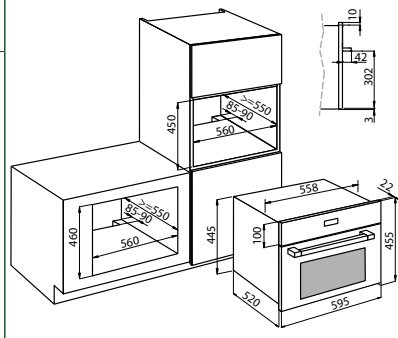

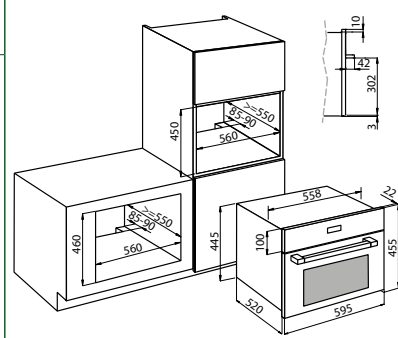

BOTTOM COOKING	TRADIT. COOKING	INTENSIVE COOKING	FANNED COOKING	CENTRAL GRILL	DOUBLE GRILL	BOTTOM COOK. + GRILL	FANNED + MAXI GRILL	FANNED + BOTTOM COOK.
								

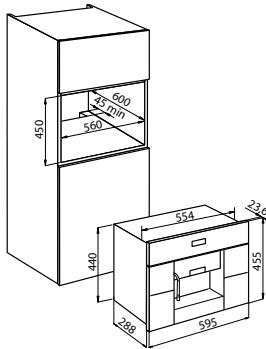

FL

Model	Finish	Ref.	Technical Drawing												
<p>FL White series micro combi 60x46 - 32 litres</p> 	<p>WHITE</p>	<p>7104 120</p> <div data-bbox="459 264 746 324"> </div> <ul data-bbox="459 340 1109 497" style="list-style-type: none"> • Combi microwave + grill + convection oven 60x46 cm - 32 litres • 1000 W microwave with 5 power settings • Selectable Grill 1500W • Max temperature 220°C • 6 cooking functions • 12 automatic cooking programs + 3 customizable cooking functions • Touch control display • Intuitive electronic programming • Stainless steel cooking chamber • Cooling system with tangential ventilation • 0-90 minutes timer • Automatic defrosting by time and weight • Disconnectable rotating plate • Full-Glass door • Chromed handle • Safety shut-off • Power supply: 220-240V 50Hz <p data-bbox="459 510 1109 555">Standard accessories: 1 Integrated rotating plate Ø 32 cm - 1 stainless steel grid glass tray</p> <div data-bbox="459 571 1021 672"> <table border="1"> <tr> <th>CONVECTION COOKING</th> <th>GRILL</th> <th>FANNED + GRILL</th> <th>MICROWAVE COOKING</th> <th>MICROWAVE + GRILL</th> <th>MICROWAVE + FANNED</th> </tr> <tr> <td></td> <td></td> <td></td> <td></td> <td></td> <td></td> </tr> </table> </div>	CONVECTION COOKING	GRILL	FANNED + GRILL	MICROWAVE COOKING	MICROWAVE + GRILL	MICROWAVE + FANNED							
CONVECTION COOKING	GRILL	FANNED + GRILL	MICROWAVE COOKING	MICROWAVE + GRILL	MICROWAVE + FANNED										
<p>FL Black Mirror series micro combi 60x46 - 32 litres</p> 	<p>BLACK MIRROR</p>	<p>7104 620</p> <div data-bbox="459 757 805 817"> </div> <ul data-bbox="459 833 1109 990" style="list-style-type: none"> • Combi microwave + grill + convection oven 60x46 cm - 32 litres • 1000 W microwave with 5 power settings • Selectable Grill 1500W • Max temperature 220°C • 6 cooking functions • 12 automatic cooking programs + 3 customizable cooking functions • Touch control display • Intuitive electronic programming • Stainless steel cooking chamber • Cooling system with tangential ventilation • 0-90 minutes timer • Automatic defrosting by time and weight • Disconnectable rotating plate • Full-Glass door • StopSol glass • Chromed handle • Safety shut-off • Power supply: 220-240V 50Hz <p data-bbox="459 1003 1109 1048">Standard accessories: 1 Integrated rotating plate Ø 32 cm - 1 stainless steel grid glass tray</p> <div data-bbox="459 1064 1021 1164"> <table border="1"> <tr> <th>CONVECTION COOKING</th> <th>GRILL</th> <th>FANNED + GRILL</th> <th>MICROWAVE COOKING</th> <th>MICROWAVE + GRILL</th> <th>MICROWAVE + FANNED</th> </tr> <tr> <td></td> <td></td> <td></td> <td></td> <td></td> <td></td> </tr> </table> </div>	CONVECTION COOKING	GRILL	FANNED + GRILL	MICROWAVE COOKING	MICROWAVE + GRILL	MICROWAVE + FANNED							
CONVECTION COOKING	GRILL	FANNED + GRILL	MICROWAVE COOKING	MICROWAVE + GRILL	MICROWAVE + FANNED										
<p>FL White series steam oven 60x46 - 35 litres</p> 	<p>WHITE</p>	<p>7103 180</p> <div data-bbox="459 1249 582 1310"> </div> <ul data-bbox="459 1326 1109 1460" style="list-style-type: none"> • Steam oven 60x46 - 35 litres • Wide cooking chamber - tray dimension 40x36 cm • Stainless steel cooking chamber • Steam cooking: 40°C - 100°C • External boiler for fast steam generation • Touch control display • intuitive electronic programming • specific cooking programs for fish, meat, vegetables and frozen • Drawer-opening water container of 1,2 litres - no water connection needed • Alert light for absence of water and descaling cycle need • Chromed handle • Door: 2 -glazed • Full-Glass door • Power supply: 220-240V 50Hz <p data-bbox="459 1473 1109 1518">Standard accessories: 1 stainless steel deep tray - 1 flat perforated stainless steel tray - 1 stainless steel grid</p> <div data-bbox="459 1556 646 1657"> <table border="1"> <tr> <th>STEAM COOKING</th> <th>DEFROST</th> </tr> <tr> <td></td> <td></td> </tr> </table> </div>	STEAM COOKING	DEFROST											
STEAM COOKING	DEFROST														
<p>FL Black Mirror series steam oven 60x46 - 35 litres</p> 	<p>BLACK MIRROR</p>	<p>7103 680</p> <div data-bbox="459 1742 646 1803"> </div> <ul data-bbox="459 1818 1109 1953" style="list-style-type: none"> • Steam oven 60x46 - 35 litres • Wide cooking chamber - tray dimension 40x36 cm • Stainless steel cooking chamber • Steam cooking: 40°C - 100°C • External boiler for fast steam generation • Touch control display • intuitive electronic programming • Programmi specifici per pesce, carne, verdure e scongelati • Drawer-opening water container of 1,2 litres - no water connection needed • Alert light for absence of water and descaling cycle need • Chromed handle • Door: 2 -glazed • Full-Glass door • StopSol glass • Power supply: 220-240V 50Hz <p data-bbox="459 1966 1109 2011">Standard accessories: 1 stainless steel deep tray - 1 flat perforated stainless steel tray - 1 stainless steel grid</p> <div data-bbox="459 2049 646 2150"> <table border="1"> <tr> <th>STEAM COOKING</th> <th>DEFROST</th> </tr> <tr> <td></td> <td></td> </tr> </table> </div>	STEAM COOKING	DEFROST											
STEAM COOKING	DEFROST														

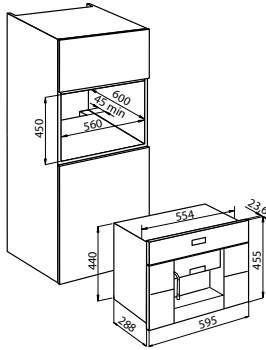
FL - coffee machine

Model	Finish	Ref.	Technical Drawing
FL White series Coffee Machine 60x46 	WHITE	2998 100	
	<ul style="list-style-type: none"> • E.S.E.coffee pod system (Easy Serving Espresso: coffee, barley, tea, ginseng) • Dispenser for steam for cappuccino) and boiling water (infusions) • touch control display and intuitive electronic programming • Automatic opening and closing of the pod-drawer and Safety shut-off • Removable water tank 2.5 liters • Sensor light for lack of water • Side compartment (for stock pods, sugar, cups, ...) • Removable drip tray • LED Lighting: 3 light points • Working pressure: 20 bar • Power supply: 220-240 V 50Hz 		
FL Black Mirror series Coffee Machine 60x46 	BLACK MIRROR	2998 600	
	<ul style="list-style-type: none"> • E.S.E.coffee pod system (Easy Serving Espresso: coffee, barley, tea, ginseng) • Dispenser for steam for cappuccino) and boiling water (infusions) • touch control display and intuitive electronic programming • Automatic opening and closing of the pod-drawer and Safety shut-off • Removable water tank 2.5 liters • Sensor light for lack of water • Side compartment (for stock pods, sugar, cups, ...) • Removable drip tray • LED Lighting: 3 light points • Working pressure: 20 bar • Power supply: 220-240 V 50Hz 		

FL - plate-warmer module

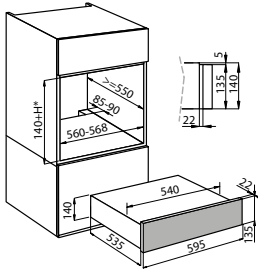
Model	Finish	Ref.	Technical Drawing
FL Plate-warmer 60x14 - 24 litres  	WHITE	7104 100	
	BLACK MIRROR	7104 600	
<ul style="list-style-type: none"> • Push-pull opening with telescopic guides • Stainless steel inner with non-slip coating • Heating resistors with level control • Max. temperature: 85°C • Maximum load: 15 kg • Power supply: 220-240V 50-60Hz 			

*Cut-out: 560x(140 mm + H oven cut-out)



Coffee Pod System

FL uses the E.S.E. system, with standard pods easy-to-find, not only for each brand of coffee, but also for ginseng, barley, tea and various infusions...



A genuine Bar

FL also dispenses boiling water and steam for the traditional preparation of tea and herbal teas, and to produce a dense foam for a perfect cappuccino!



Simple maintenance

The coffee machine does not require connection to the water supply. The large water tank is easy to access, an indicator alerts the need for filling.

FL - multifunction blast chiller

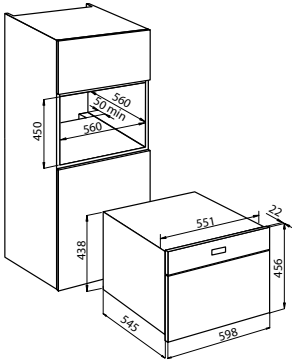
Model	Finish	Ref.	Technical Drawing
FL blast chiller multifunctional 60x46 - 40 litres  Available from June 2017	BLACK MIRROR	2980 600	
<ul style="list-style-type: none"> • Built-in multifunction blast chiller 60x46 cm, volume 40 lt • 11 programs • TFT touch-control display • Assisted intuitive programming • Stainless steel chamber • LED lighting • Over-temperature protection sensors • Exercise temperature +75°C / -30°C <p>Standard features: Temperature probe - high-temperature glass tray - steel grid</p> <p>Power supply: 220-240V 50Hz Maximum power: 300 W</p>			



The freezer preserves food but it is not suitable for deep-freezing. The blast chiller chills the product in a limited amount of time, enabling a micro-crystallization which preserves the organoleptic characteristics of food unaltered.



The temperature probe is a useful accessory. It makes it possible to obtain a precise result at the end of the chilling or cooking process.



The FL blast chiller is simple and intuitive to use. Simple questions guide to set all parameters, even by a beginner.

Blast chiller functions



Temperature dropping to +3°C

It reduces the time of permanence in the bacteria proliferation temperature range, and increases the shelf-life of food. The quick drop in temperature also blocks water evaporation.



Raw food sanitization through temperature drop to -30°C

Bad conservation of seafood can cause health hazards due to contamination with Anisakis, a parasite which can be eliminated with a deep-freezing at -30°C.



Deep-freezing at -18°C

It makes months long conservation possible. The organoleptic properties, savour, aroma and aspect of food remain unaltered because of the micro-crystallization of water which prevents fibres from breaking apart.



Controlled defrosting of deep-freeze food

The program brings food from deep-freeze temperature to 1÷3°C without losing its liquids and without commencing its cooking, and thus avoiding the transformation of proteins which is brought on by the microwave.



Rapid pre-chilling to optimize program-execution time

It reduces the time of execution of programs by chilling the inner parts of the appliance before use.



Food regeneration at serving temperature

This program warms at proper serving temperature food which was pre-cooked and kept in the refrigerator.



Rapid chilling of food after cooking

It is possible to accelerate the chilling process, down to the required temperature, without waiting for natural acclimatization.



Low-temperature cooking

This function cooks food at a constant temperature for a given time. Thanks to the limited evaporation of water from the food, it maintains the quality and tenderness of the food.



Quick chilling of beverages to service temperature

This program quickly chills up to six bottles of beverage to the required temperature.



Rising with temperature- and humidity-control

This program creates a micro-climate with controlled temperature and humidity in which fermentation can take place in a perfect environment. By programming the duration, it is possible to reduce the quantity of yeast, and obtain a lighter and easier to digest food.









0°C conservation of prepared food

This program is suitable to preserve food such as meat, fish or vegetables for a few hours before their preparation.

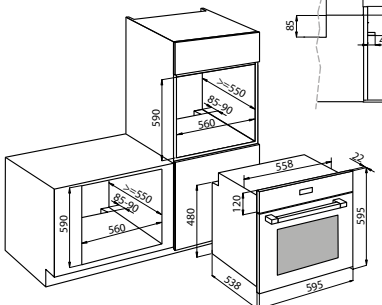
FL Vintage

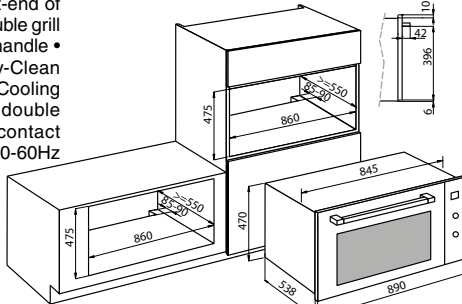

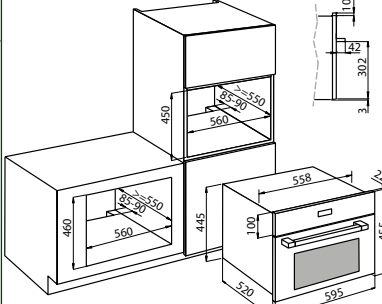
Model	Finish	Ref.	Technical Drawing
<p>FL Vintage - 60 multifunctional 60x60 - 65 litres</p> 	<p>VINTAGE</p>	<p>7105 042</p>  <p>• Multifunctional oven 60x60 cm, 65 litres capacity • 14 cooking functions • 17 automatic cooking programs • touch control display • intuitive electronic programming • Heat probe for temperature control • Fast pre-heating function • Collapsible double grill • 2 fully extractable telescopic guides • Door: 3-glazed • Full-Glass door • Removable door glasses • Chromed handle • Easy-Clean enamelling • Protection for grill heating element • Cooling system with tangential ventilation • Asymmetric double halogen light, light-on at door opening • Door contact switch • Safety shut-off • Energy class: A • Power supply: 220-240V 50-60Hz Standard accessories: 1 tray (code 9401 539) and 1 drip tray XXL (code 9401 538), stainless steel grid and trays handle</p> <p>Accessories: 2a (see page 163)</p>	
<p>FL Vintage - 90 multifunctional 90x48 - 91 litres</p> 	<p>VINTAGE</p>	<p>7107 042</p>  <p>• Multifunctional oven 90x48 cm, 91 litres capacity • 9 cooking functions • Electronic programming of start-end of cooking Retractable selection knobs • Collapsible double grill • 2 telescopic guides • Door: 3-glazed • Chromed handle • Full-Glass door • Removable door glasses • Easy-Clean enamelling • Protection for grill heating element • Cooling system with tangential ventilation • Asymmetric double halogen light, light-on at door opening • Door contact switch • Energy class: A • Power supply: 220-240V 50-60Hz</p> <p>Standard accessories: deep tray stainless steel grid Accessories: 2b (see page 163)</p>	<p>Standard accessories: deep tray stainless steel grid Accessories: 2b (see page 163)</p> 
<p>FL micro Vintage micro combi 60x46 - 32 litres</p> 	<p>VINTAGE</p>	<p>7104 020</p>  <p>• Combi microwave + grill + convection oven 60x46 cm - 32 litres • 1000 W microwave with 5 power settings • Selectable Grill 1500W • Max temperature 220°C • 6 cooking functions • 12 automatic cooking programs + 3 customizable cooking functions • Touch control display • Intuitive electronic programming • Stainless steel cooking chamber • Cooling system with tangential ventilation • 0-90 minutes timer • Automatic defrosting by time and weight • Disconnectable rotating plate • Full-Glass door • StopSol glass • Chromed handle • Safety shut-off • Power supply: 220-240V 50Hz</p> <p>Standard accessories: 1 Integrated rotating plate Ø 32 cm - 1 stainless steel grid - 1 glass drip tray</p>	
<p>UPPER COOKING</p> <p>BOTTOM COOKING</p> <p>TRADIT. COOKING</p> <p>INTENSIVE COOKING</p> <p>FANNED COOKING</p> <p>PIZZA FUNCTION</p> <p>CENTRAL GRILL</p> <p>DOUBLE GRILL</p> <p>BOTTOM COOK. + GRILL</p> <p>BOTTOM COOK. + DOUBLE GRILL</p> <p>FANNED + MAXI GRILL</p> <p>FANNED + GRILL</p> <p>LOW TEMPERATURE MAINTENANCE</p> <p>HEAT</p>	<p>BOTTOM COOKING</p> <p>TRADIT. COOKING</p> <p>INTENSIVE COOKING</p> <p>FANNED COOKING</p> <p>CENTRAL GRILL</p> <p>DOUBLE GRILL</p> <p>BOTTOM COOK. + GRILL</p> <p>FANNED + MAXI GRILL</p> <p>FANNED + BOTTOM COOK.</p>	<p>CONVECTION COOKING</p> <p>GRILL</p> <p>FANNED + GRILL</p> <p>MICROWAVE COOKING</p> <p>MICROWAVE + GRILL</p> <p>MICROWAVE + FANNED</p>	

Foster Milano









Model	Finish	Ref.	Technical Drawing
-------	--------	------	-------------------

Milano 90
multifunctional 90x47 - 73 litres











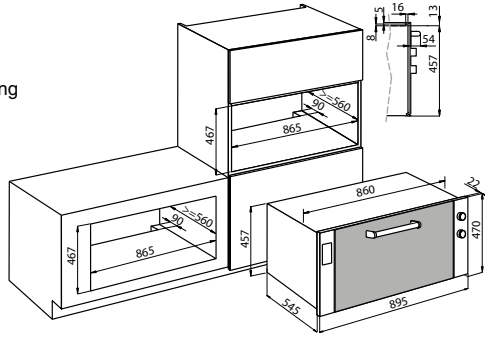

Foster brushed  **7167 052**

- Multifunctional oven 90x47 cm, 73 litres capacity
- 9 cooking functions
- Electronic programming of start and end of cooking
- Cooling system with tangential ventilation
- Telescopic guides
- Door: 3-glazed
- StopSol glass
- Easy-Clean enamelling
- Independent inside light
- Energy class: A
- Power supply: 220-240 V 50 Hz

Standard accessories:
1 grid
1 tray with EasyClean enamelling
1 spit - self-cleaning catalytic panels
Accessories: 2b-4c (see page 163)











BOTTOM COOKING	SUPERIOR COOKING	TRADIT. COOKING	FANNED COOKING	FANNED + GRILL	INTENSIVE COOKING	GRILL	DEFROSTING	GRILL + SPIT
								

Foster Milano 70
multifunctional 70x60 - 75 litres

NEW









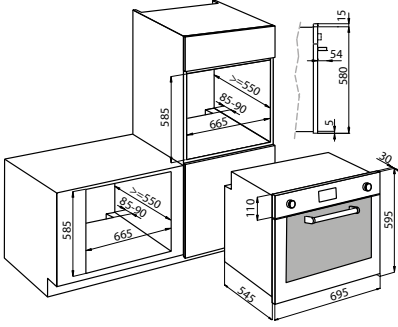

Foster brushed  **7162 052**













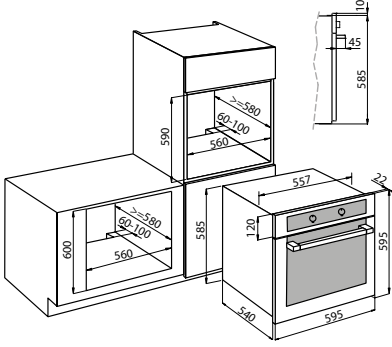











































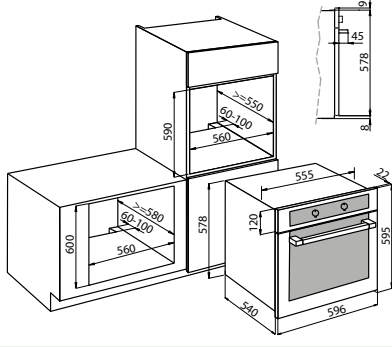











































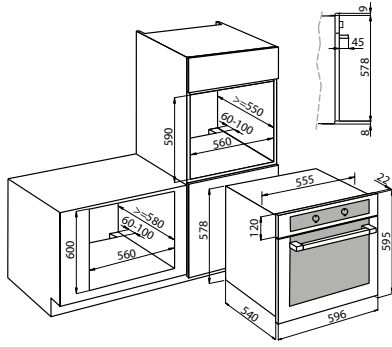

























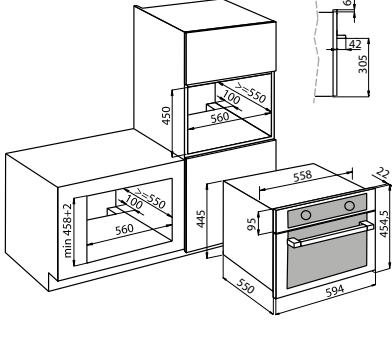



















- Multifunctional oven 70x60 cm, 75 litres capacity
- 8 cooking functions
- Electronic programming of start and end of cooking
- Cooling system with tangential ventilation
- 2 telescopic guides
- Door: 3-glazed
- StopSol glass
- Easy-Clean enamelling
- Independent inside light
- Energy class: C
- Power supply: 220-240 V 50 Hz

Standard accessories:
2 grids
1 tray with EasyClean enamelling
Accessories: 2a (see page 163)











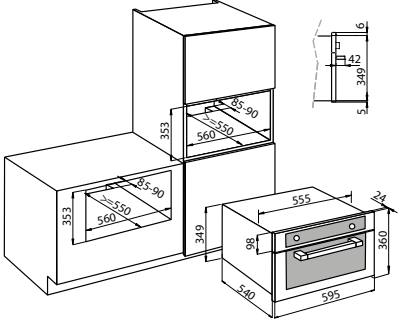





BOTTOM COOKING	SUPERIOR COOKING	TRADIT. COOKING	FANNED COOKING	FANNED + GRILL	INTENSIVE COOKING	GRILL	DEFROSTING
							

KE

Model	Finish	Ref.	Technical Drawing																									
multifunctional pyrolytic 60x60 65 litres 	brushed anti-touch 	7143 044																										
<table border="1" style="width:100%; text-align:center;"> <tr> <td>A</td> <td>XL</td> <td></td> <td></td> <td></td> <td></td> <td></td> </tr> </table> <p> • Pyrolytic oven 60x60 cm, 65 litres capacity • 10 cooking functions • Pyrolysis self-cleaning • Electronic programming of start and end of cooking • 2 telescopic guides • Cooling system with tangential ventilation • Door: 4-glazed • Full-Glass door • Removable door glasses • Anti-touch finish • Energy class: A • Power supply: 220-240 V, 50-60 Hz </p> <p> Standard accessories: 1 drip tray with EasyClean enamelling XXL 1 stainless steel grid Accessories: 2a (see page 163) </p> <table border="1" style="width:100%; text-align:center;"> <tr> <td>BOTTOM COOKING</td> <td>TRADIT. COOKING</td> <td>INTENSIVE COOKING</td> <td>FANNED COOKING</td> <td>PIZZA FUNCTION</td> <td>FANNED + GRILL</td> <td>DOUBLE GRILL</td> <td>CENTRAL GRILL</td> <td>DEFROSTING</td> </tr> <tr> <td></td> <td></td> <td></td> <td></td> <td></td> <td></td> <td></td> <td></td> <td></td> </tr> </table>				A	XL						BOTTOM COOKING	TRADIT. COOKING	INTENSIVE COOKING	FANNED COOKING	PIZZA FUNCTION	FANNED + GRILL	DOUBLE GRILL	CENTRAL GRILL	DEFROSTING									
A	XL																											
BOTTOM COOKING	TRADIT. COOKING	INTENSIVE COOKING	FANNED COOKING	PIZZA FUNCTION	FANNED + GRILL	DOUBLE GRILL	CENTRAL GRILL	DEFROSTING																				
																												
KE series multifunctional 60x60 - 63 litres 	brushed anti-touch 	7142 043																										
<table border="1" style="width:100%; text-align:center;"> <tr> <td>A</td> <td>XL</td> <td></td> <td></td> <td></td> <td></td> <td></td> </tr> </table> <p> • Multifunctional oven 60x60 cm, 63 litres capacity • 9 cooking functions • Electronic programming of start and end of cooking • Heat probe for temperature control • Cooling system with tangential ventilation • 2 telescopic guides • Door: 3-glazed • Full-Glass door • Removable door glasses • Easy-Clean enamelling • Protection for grill heating element • Anti-touch finish • Energy class: A • Power supply: 220-240 V 50-60 Hz </p> <p> Standard accessories: 1 tray and 1 drip tray with EasyClean enamelling XXL 1 stainless steel grid Accessories: 2a (see page 163) </p> <table border="1" style="width:100%; text-align:center;"> <tr> <td>BOTTOM COOKING</td> <td>TRADIT. COOKING</td> <td>FANNED COOKING</td> <td>FANNED + GRILL</td> <td>INTENSIVE COOKING</td> <td>ENERGY SAVING</td> <td>DOUBLE GRILL</td> <td>CENTRAL GRILL</td> <td>BOTTOM COOK. + GRILL</td> </tr> <tr> <td></td> <td></td> <td></td> <td></td> <td></td> <td></td> <td></td> <td></td> <td></td> </tr> </table>				A	XL						BOTTOM COOKING	TRADIT. COOKING	FANNED COOKING	FANNED + GRILL	INTENSIVE COOKING	ENERGY SAVING	DOUBLE GRILL	CENTRAL GRILL	BOTTOM COOK. + GRILL									
A	XL																											
BOTTOM COOKING	TRADIT. COOKING	FANNED COOKING	FANNED + GRILL	INTENSIVE COOKING	ENERGY SAVING	DOUBLE GRILL	CENTRAL GRILL	BOTTOM COOK. + GRILL																				
																												
KE series multifunctional 60x60 - 63 litres 	brushed anti-touch 	7141 042																										
<table border="1" style="width:100%; text-align:center;"> <tr> <td>A</td> <td>XL</td> <td></td> <td></td> <td></td> </tr> </table> <p> • Multifunctional oven 60x60 cm, 63 litres capacity • 5 cooking functions • Electronic programming of start and end of cooking • Cooling system with tangential ventilation • 1 telescopic guide • Door: 2-glazed • Full-Glass door • Removable door glasses • Easy-Clean enamelling • Protection for grill heating element • Anti-touch finish • Energy class: A • Power supply: 220-240 V 50-60 Hz </p> <p> Standard accessories: 1 tray and 1 drip tray with EasyClean enamelling XXL 1 stainless steel grid Accessories: 2a (see page 163) </p> <table border="1" style="width:100%; text-align:center;"> <tr> <td>BOTTOM COOKING</td> <td>DOUBLE GRILL</td> <td>BOTTOM COOK. + GRILL</td> <td>FANNED + GRILL</td> <td>DEFROSTING</td> </tr> <tr> <td></td> <td></td> <td></td> <td></td> <td></td> </tr> </table>				A	XL				BOTTOM COOKING	DOUBLE GRILL	BOTTOM COOK. + GRILL	FANNED + GRILL	DEFROSTING															
A	XL																											
BOTTOM COOKING	DOUBLE GRILL	BOTTOM COOK. + GRILL	FANNED + GRILL	DEFROSTING																								
																												
KE series micro combi 60x46 - 44 litres 	brushed anti-touch 	7146 020																										
<table border="1" style="width:100%; text-align:center;"> <tr> <td></td> <td></td> <td></td> <td></td> <td></td> <td></td> <td></td> <td></td> <td></td> <td></td> </tr> </table> <p> • Combi oven convection+grill+microwave 60x46 cm - 44 litres • Microwave 900 W • Convection and grill 1750W • Max temperature 230°C • 10 cooking functions • LED display with touch-control and knobs • 15 automatic programs • Finger-proof finish • Stainless steel cooking chamber • Door: 3-glazed • Tangential ventilation • 0-90 minutes timer • Automatic defrosting by time and weight • Rotating plate ø 36 cm • Full-Glass door • Power supply: 230 V 50 Hz </p> <p> Standard accessories: 2 stainless steel grids (grill grids with different height) 1 round enamelled baking pan Accessories: 1-3 (see page 163) </p>																												
																												

KE

Model	Finish	Ref.	Technical Drawing						
KE Compact ventilated 60x36 - 35 litres NEW	brushed anti-touch 	7170 062							
	   	<ul style="list-style-type: none"> • Ventilated oven 60x36 cm, volume 35 litres • 3 cooking functions • Electronic programming of start and end of cooking • Cooling system with tangential ventilation • Door: 3-glazed • StopSol glass • Easy-Clean enamelling • Full-Glass door • Anti-touch finish • Energy class: A • Power supply: 220-240 V 50 Hz Standard accessories: 1 tray with EasyClean enamelling - 1 stainless steel grid Accessories: 2a (see page 163)							
Available from September 2017	<table border="1"> <tr> <th>CENTRAL GRILL</th> <th>FANNED COOKING</th> <th>FANNED + GRILL</th> </tr> <tr> <td></td> <td></td> <td></td> </tr> </table>	CENTRAL GRILL	FANNED COOKING	FANNED + GRILL					
CENTRAL GRILL	FANNED COOKING	FANNED + GRILL							
									











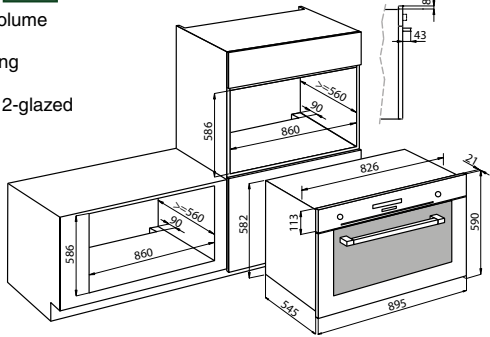





























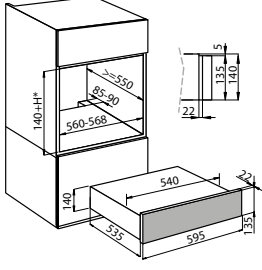

Model	Finish	Ref.	Technical Drawing																
KE 90 multifunctional 90x60 - 103 litres	brushed anti-touch 	7126 047																	
	     	<ul style="list-style-type: none"> • Multifunctional oven 90x60 cm, 103 litres gross volume • 8 cooking functions • Electronic programming of start and end of cooking • Digitale display • Cooling system with tangential ventilation • Door: 2-glazed • StopSol glass • Full-Glass door • Easy-Clean enamelling • Protection for grill heating element • Independent inside light • Anti-touch finish • Power supply: 220-240 V 50-60 Hz Standard accessories: 2 grids 1 enamelling drip tray Accessories: 2b (see page 163)																	
	<table border="1"> <tr> <th>BOTTOM COOKING</th> <th>TRADIT. COOKING</th> <th>INTENSIVE COOKING</th> <th>FANNED COOKING</th> <th>CENTRAL GRILL</th> <th>DOUBLE GRILL</th> <th>FANNED + GRILL</th> <th>FANNED COOKING + BOTTOM</th> </tr> <tr> <td></td> <td></td> <td></td> <td></td> <td></td> <td></td> <td></td> <td></td> </tr> </table>	BOTTOM COOKING	TRADIT. COOKING	INTENSIVE COOKING	FANNED COOKING	CENTRAL GRILL	DOUBLE GRILL	FANNED + GRILL	FANNED COOKING + BOTTOM										
BOTTOM COOKING	TRADIT. COOKING	INTENSIVE COOKING	FANNED COOKING	CENTRAL GRILL	DOUBLE GRILL	FANNED + GRILL	FANNED COOKING + BOTTOM												
																			

Plate-warmer module KE-KS

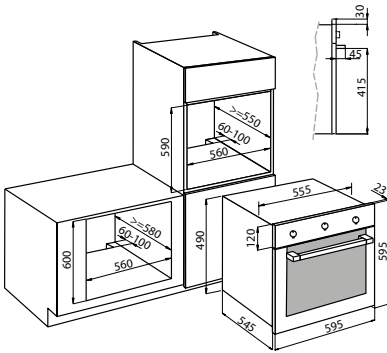
Model	Finish	Ref.	Technical Drawing
KE-KS Plate-warmer 60x14 - 24 litres NEW	brushed anti-touch 	7104 000	
	<ul style="list-style-type: none"> • Push-pull opening with telescopic guides • Stainless steel inner with non-slip coating • Heating resistors with level control • Max temperature: 85°C • Maximum load: 15 kg • Power supply: 220-240V 50-60Hz 		
			*Cut-out: 560x(140 mm + H oven cut-out)

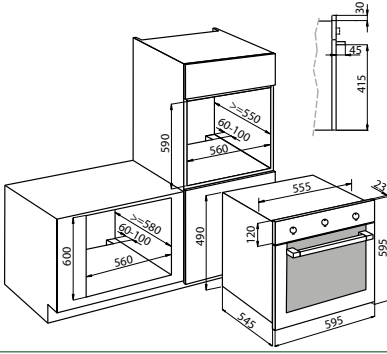
KS

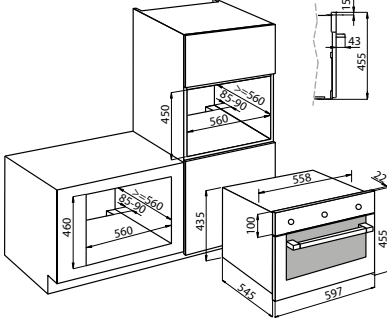
Model	Finish	Ref.	Technical Drawing
KS series multifunctional PP 60x60 - 63 litres 	brushed anti-touch 	7120 054	
KS series multifunctional PP 60x60 - 63 litres 	brushed anti-touch 	7122 051	
KS series multifunctional PP 60x46 - 42 litres 	brushed anti-touch 	7123 040	
KS 60 gas Ventilated gas 60x60 - 63 litres 	brushed anti-touch 	7191 061	

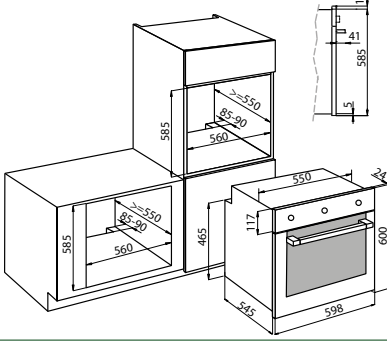

Model	Finish	Ref.	Technical Drawing
-------	--------	------	-------------------

multifunctional 60x60 - 63 litres

brushed anti-touch



7111 042



• Multifunctional oven 60x60 cm, 63 litres capacity • 5 cooking functions • End of cooking time • Cooling system with tangential ventilation • Door: 3-glazed • Full-Glass door • Soft Closing door • Anti-touch finish • Energy class: A • Power supply: 220-240 V, 50-60 Hz



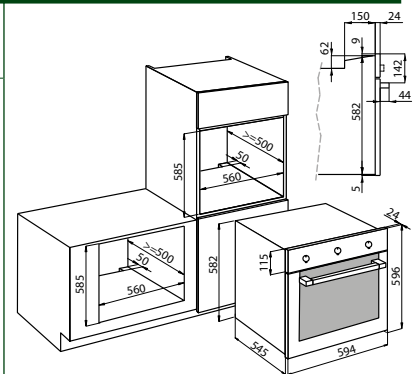



Standard accessories:
1 drip tray with EasyClean enamelling XXL
1 stainless steel grid



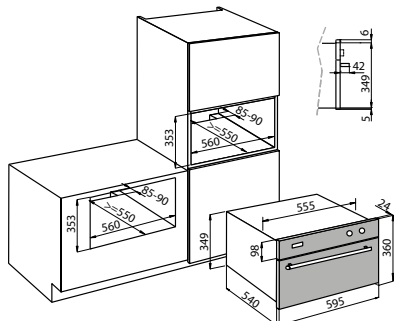







Available from July 2017

TRADIT. COOKING	INTENSIVE COOKING	FANNED + GRILL	DOUBLE GRILL	LIGHT

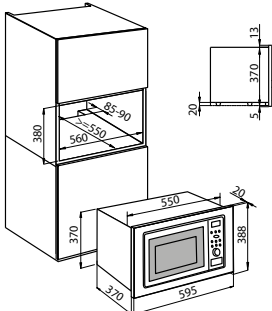
Elettra

Model	Finish	Ref.	Technical Drawing
<p>Elettra Compact ventilated 60x36 - 35 litres</p> 	<p>dark glass</p>	<p>7170 052</p>	
<p>A  StopSol </p>		<p>• Ventilated oven 60x36 cm, volume 35 litres • 3 cooking functions • Electronic programming of start and end of cooking • Cooling system with tangential ventilation • Door: 3-glazed • StopSol glass • Easy-Clean enamelling • Full-Glass door • Anti-touch finish • Energy class: A • Power supply: 220-240 V 50 Hz</p> <p>Standard accessories: 1 tray with EasyClean enamelling - 1 stainless steel grid</p> <p>Accessories: 2a (see page 163)</p>	
<p>CENTRAL GRILL </p>		<p>FANNED COOKING </p>	<p>FANNED + GRILL </p>

1000 series























Model	Finish	Ref.	Technical Drawing
<p>Micro+Grill S1000 micro+grill 60x38 - 25 litres</p> 	<p>brushed anti-touch </p>	<p>7151 000</p>	
<p>• Micro+grill 60x38 cm, 25 litres capacity • 5 cooking functions • 6 power settings up to 900 W (1000 W Grill) • Electronic programming • Automatic defrosting by time and weight • Stainless steel cooking chamber • Power supply: 220-240 V 50 Hz</p> <p>Standard accessories: 1 grid - 1 rotating plate</p>		<p>MICROWAVE COOKING  GRILL  MICROWAVE + GRILL  AUTOMATIC THAWING  PRE-SET PROGRAMMES </p>	



Hoods

In the modern kitchen the cooker hood has an increasingly important role, both as an interior design object and as a tool to improve the pleasure of using and living the kitchen.

Fulfilling the dual principle of aesthetics and functionality, the Foster hoods perfectly follow the modern design guidelines, offering at the same time efficient performances and high manufacturing standards.

Modular p. 187		Maya p. 196		Amélie p. 204	
Modular Trio p. 188		FL Slim p. 197		Wing Space p. 205	
Breeze p. 189		Stripe p. 198		Wing p. 206	
Cloud p. 190		Q inox p. 199		Garage p. 207	
Sky p. 191		Master p. 200		Flat 208	
Geko p. 192		KS Lux p. 201		Pitagora p. 209	
S4000 Mirror p. 193		KS 90 p. 202			
Ghost p. 194		Sunset p. 203			

Silent power

Power and quietness are the two principal features of a cooker hood, even though they are often in contrast with one-another. The continuous strive for the best compromise is however nowadays able to achieve surprising results. All the Foster solutions have an outstanding suction power which makes them efficient and well-performing in all conditions of use, both in extracting and filtering modes. All this is achieved quietly, thanks to motors and aerodynamic solutions carefully studied to reduce the acoustic impact to a minimum.

High performance motors

The motors of the S4000 hoods have a high suction capacity. Their refined design hides a powerful appliance with professional features.

Silent System motors

The new Silent System motors sport a very high efficiency leading to top suction-power coupled with reduced consumption and a noise-level 10 times lower compared to standard solutions.

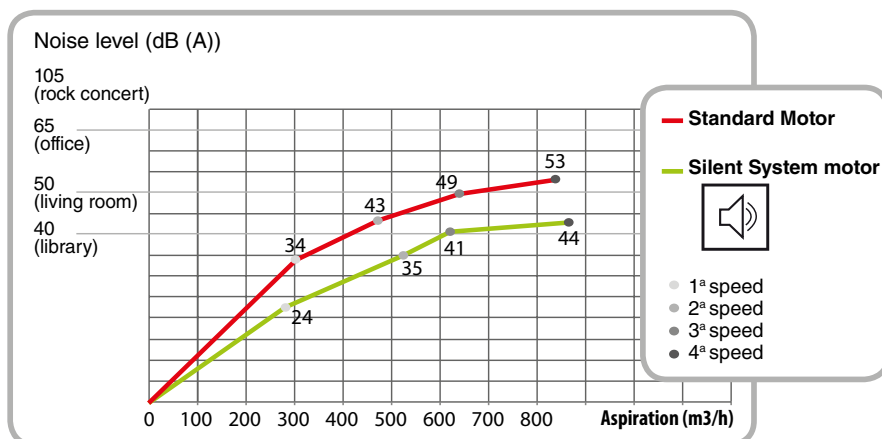

A hood for every kitchen

A really complete range, with every kind of hood. Non only different looks, but also different functioning principles, in order to be able to choose the hood which fits each one's needs.



 **Wall-mount hoods**
A large range of choices in size, shape, materials and functionality.



 **Island hoods**
For many models an island version is also available. These hoods are easy to install thanks to the telescopic chimneys.



 **Ceiling-mount suction systems**
These are not mere hoods for aspiring cooking fumes, but complete ventilation systems, engineered to improve the quality of the air and the comfort of your living space.



 **Table hoods**
Elegant and minimalistic solutions which perfectly match the Domino and In-line cooker hobs, both gas and induction.



 **Built-in hoods**
These special solutions are craftily studied to disappear within the kitchen cabinets, nevertheless maintaining their own personality and great functionality.



 **Custom-made hoods**
Foster specialises in tailor-made solutions. As for the worktops, also for the hoods Foster is able to manufacture custom-made products according to the customer's drawing, always guaranteeing the best match between worktop and cooker hood, in terms both of design and kind and finish of steel.

Filters

All the Foster hoods are, in their original configuration, suction hoods, and are equipped with grease, beehive, multilayer, anodized aluminium filters. Wherever it is not possible to install a suction hood, the addition of active carbon filters (available as accessory) can transform the hood in “filtering” hood.



Remark: the grease filters can periodically be washed in the dishwasher in order to bring them back to their original filtering efficiency. It is however recommended to use a low-temperature programme (max. 40° C) to avoid any deformation and colour-change of the aluminium surfaces.



Stainless steel filters

In many models, especially the ones where the filter is in plain sight, the aluminium filtering element is covered in stainless steel. This solution improves the look and increases the durability of the product.

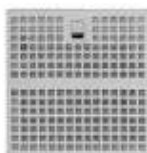

Standard stainless steel filter

It guarantees an excellent filtering function, thanks to the double stainless steel filtering layer, and as many as five layers of aluminium beehive structure.

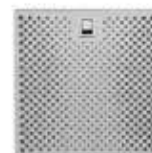

Hi-class stainless steel filter

It features a peculiar and elegant look, as well as an heightened filtering power due to the seven-layer structure.



Perimeter suction

The perimeter suction is a feature common to many Foster hoods. The filters are hidden by steel- or crystal plates and the suction occurs along their perimeter. This has aesthetic advantages but also functional ones: the cleaning is easier, the suction power and noise-level are improved. The depression which occurs in the perimeter area facilitates in fact the suction of the particles composing the fumes.



Balanced suction system

This feature, exclusively available on Foster hoods, improves the suction uniformity on the whole surface, thanks to a specific, irregular perforation pattern that compensates the loss of suction power in the terminal tracts. it is particularly efficient in the island hoods and in the wall hoods of large size (120 cm).

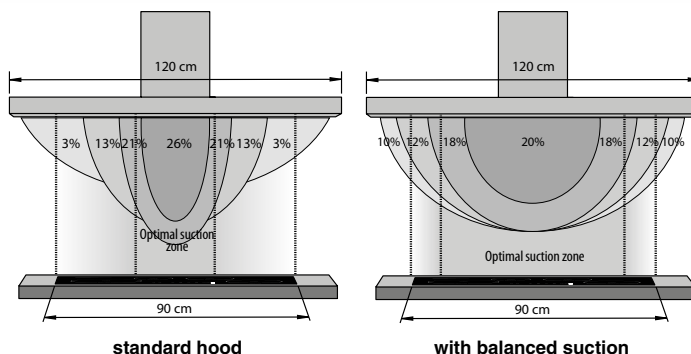

standard hood

with balanced suction



Lighting

The Foster hoods have different lighting systems, all intended to create a comfortable and safe illumination of the cooking space, with a keen eye on energy saving.



LED lighting

Many Foster hoods feature a LED lighting system, with 10 times less power consumption and 10 times more durability. The LED lighting furthermore makes a very comfortable and efficient light.



Neon lighting

The Ghost table hood is equipped with a neon lighting system that ensures an homogeneous and extended illuminated area even though the light source is close to the cooker hob.



LED lighting plates

The Modular ceiling suction system is conceived to be able to be the kitchen main lighting source. It features high power, efficient LED lighting plates which guarantee a natural and comfortable lighting, while granting a considerable energy saving.

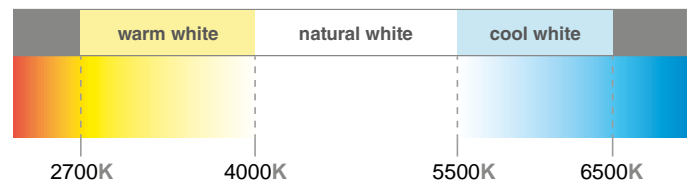

Color temperature

The color of light is very important for the welfare of a long living room like the kitchen. The LED lights of Foster hoods are neutral lights with a temperature close to natural light, particularly comfortable.

Digital control

Almost all Foster hoods are equipped with advanced electronic controls that allow a perfect control and improve the efficiency of the engines. The different solutions favor the aesthetic or functional aspect with additional functions such as digital thermometer and the timer, always useful for keep control of your preparations.



Remote control

The ceiling suction systems and the Maya hoods are equipped with a remote control to easily activate all their functions from any position.



Choice suggestions

The correct choice of power and kind of installation are important in order to achieve good performances, efficiency, noise-level and consumption. In order to avoid possible mistakes when buying, we list hereafter some suggestions to make the choice easier.



Choice of the flow capacity

The suction power of the hood must be correctly dimensioned compared to the volume of the room in which it is installed, in order to ensure a correct air circulation. The optimal air flow can be calculated by multiplying the volume of the room by 12 (number of complete air volume replacements in one hour). For ceiling suction systems it is recommended to calculate an air replacement of 15 cycles/hour.

$$\begin{array}{c}
 \boxed{\text{m}^2} \quad \times \quad \boxed{h} \quad \times \quad \boxed{12} \\
 \text{Kitchen area} \quad \quad \text{Kitchen height} \quad \quad \text{Number of complete air replacements} \\
 \quad \quad \quad \quad \quad \quad \quad \quad \quad \quad \quad \quad \text{per hour} \\
 \\
 = \\
 \boxed{\text{m}^3/\text{h}} \\
 \text{Air flow (necessary suction power)}
 \end{array}$$

Positioning on the cooker hob

The optimal height above the cooker hob is 65 cm and anyway comprised between 60 and 70 cm. For wall hoods with inclined suction surface (Garage hoods excluded), this height is determined starting from the median point of the filtering area.

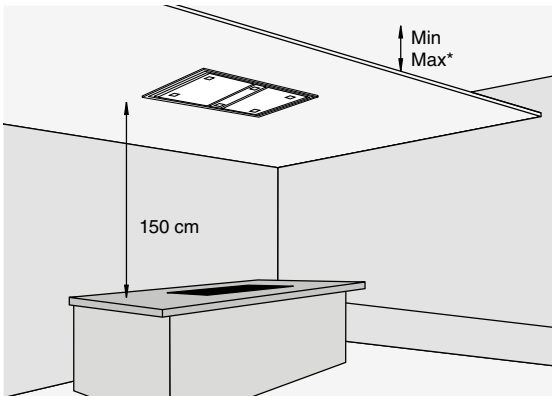
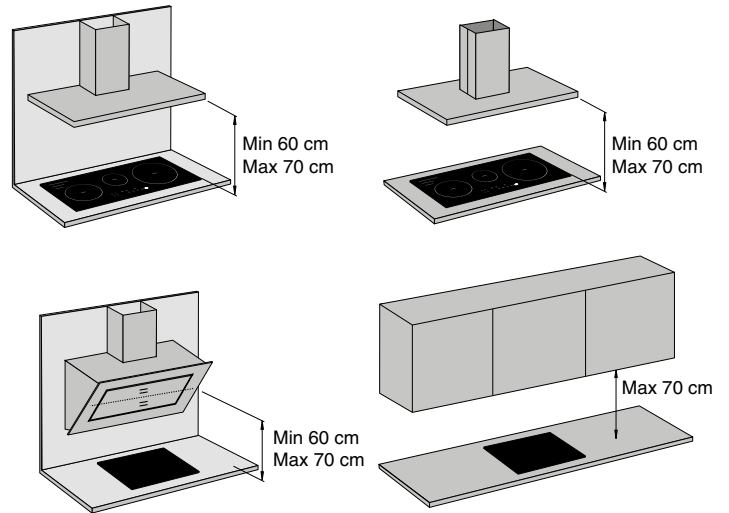

For the ceiling systems a ceiling-panelling height of maximum 150 cm from the cooker hob is recommended. The fixing systems of the hood makes it possible to regulate the distance between ceiling and panelling, based on specific needs. *See min. and max. dimensions for each specific model.

Width of hood

The dimension of the hood must be adapted to the size of the cooker hob underneath. A slightly larger hood compared to the hob will ensure an optimized suction.

Placement of pipelines

It is advisable to foresee extraction air ducts as straight as possible, without bends or corners. A tortuous extraction duct will determine a loss of suction power and therefore a less-than-optimal performance. Moreover, it is important not to connect the air exit-duct with chimneys of other appliances or heating boilers.

Air currents

In order for the hood to perform efficiently it is important to position it in a place not subject to air streams.

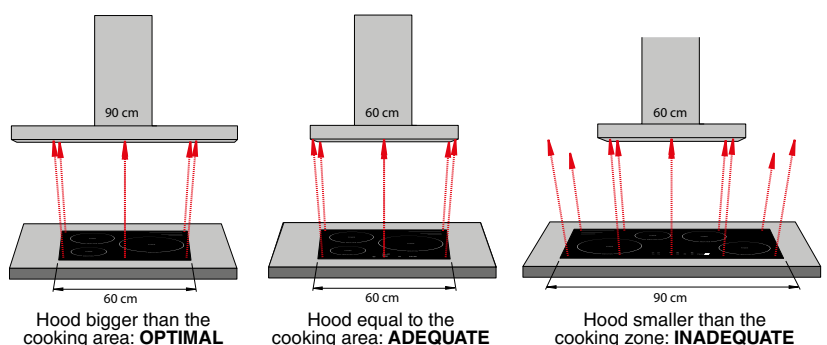



Special functions

AUTO **Auto Mode function**
 With the Auto function the hood has temperature sensors and it can automatically set the suction power according to the heat developed by the cooker hob underneath.

 **Off-Timer**
 All the models with electronic interface can be programmed to turn off the suction at a postponed moment, so as to prolong the aeration of the room even after the cooking has been completed.

 **Rear exit mode**
 The motor can be rotated by 90°. In consequence the air outlet can be directed towards the back, the classical solution, but also toward the wall, with direct exit towards a specifically foreseen duct. With this kind of installation the chimney is therefore no longer necessary and is, in consequence, supplied as an option.

 **Filter-cleaning alarm**
 This function keeps track of the hours of use of the hood and signals the need to wash the filters in order to maintain the perfect efficiency of the hood.

 **Safe&Clean system**
 The Safe&Clean system features a stainless steel panel installed between the hood's filters and motor. The panel constitutes a flat and easy-to-clean surface, it improves the suction homogeneity on the whole surface and is also an efficient safety system because it prevents the fan and electronic parts from being easily accessible.

 **Space saving**
 In undercabinet installations, the motor located in top position allows recover 60% of the useful space of the cabinet, reducing furthermore the noise level.

 **Swiveling or four-exit-position motors**
 Swiveling or four-exit motors are flexible systems that allow an easy installation, in any situation.

 **Thin encumbrance**
 Foster ceiling-mount ventilation systems require little space. The icon appears next to models that require less than 20 cm between the concrete ceiling and the countertop.

Accessories

Silencing kit
 It consists of a sound-absorbing, highly flexible and extendable tube, which can reduce the noise-level of the hood by as much as 7 dB(A). It also functions as thermal insulation. It is available as accessory for all the hoods in suction mode, with 120 and 150 mm diameter.



cod. 9700 602
 silencing kit 10 mt ø 120 mm

cod. 9700 603
 silencing kit 10 mt ø 150 mm

Intake manifolds for ceiling systems

These make it possible to channel the various possible configurations of the ceiling suction systems into a single pipe.

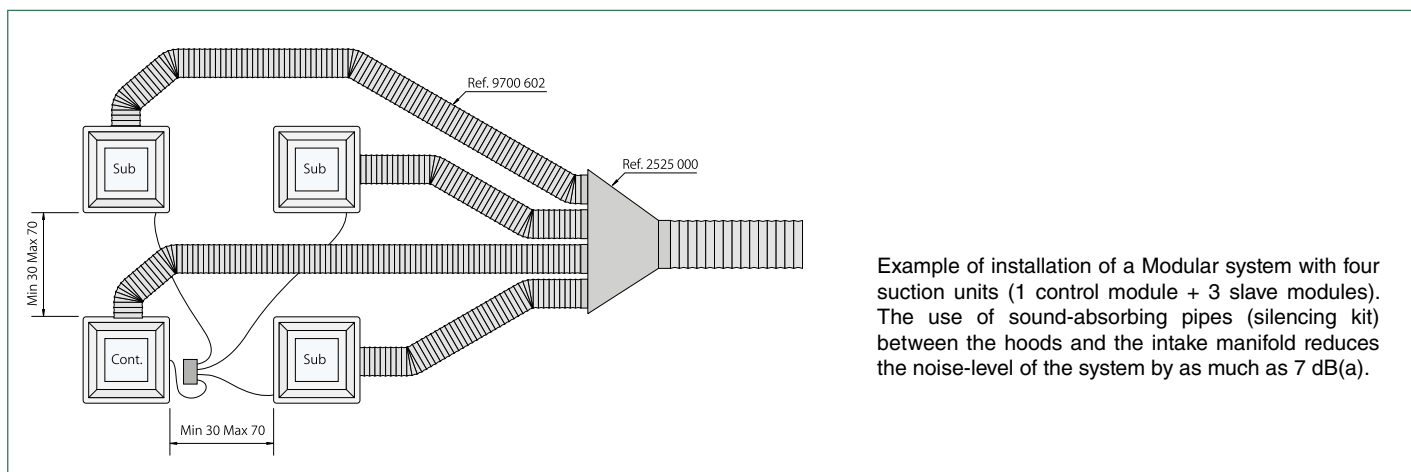
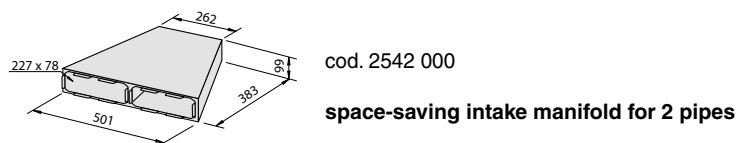
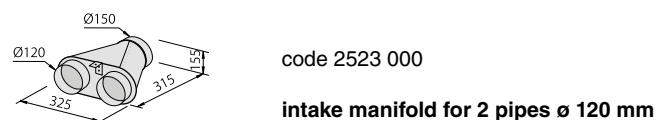

Modular



Model	Ref.	Technical Drawing
modular control	2518 001	
modular subordinate	2519 001	

The Control module (which is necessary) can control up to three Subordinate modules (for a total of maximum 4 suction units).

Modular Control & Subordinate



Modular Control & Subordinate
ceiling modular suction system
Finish:
satin stainless steel - white glass
1 grease filter
4 speeds
LED Low consumption lighting (4.000 kelvin)
Perimetric aspiration
Automatic delayed shutdown

Remote control included in Modular Control model only

Air flow rate: **400 m³/h**
Air exhaust hole: Ø 120 mm
Motor power: 140 W
Energy Class: D

Suspended ceiling height:
min 220 mm / max 310 mm

NOTE: THE HEIGHT OF THE HOOD AND THE COOKING SURFACE SUGGESTS THE USE OF AT LEAST TWO MODULES FOR AN ADEQUATE SUCTION.

“Filtering mode” option not available for this model

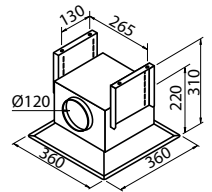

accessories:	Ref.
silencing kit Ø 120 mm	9700 602
intake manifold for 2 pipes - in Ø120 / out Ø150 mm	2523 000
intake manifold for 3 pipes - in Ø120 / out Ø200 mm	2524 000
intake manifold for 4 pipes - in Ø120 / out Ø200 mm	2525 000

Modular Light

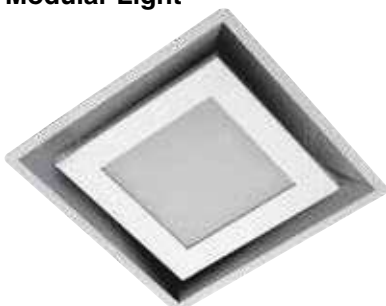

modular light 2520 001

Modular light
Finish: **satin stainless steel - white glass**
LED Low consumption lighting (4.000 kelvin)

Suspended ceiling height:
min 220 mm / max 310 mm

accessories:
Connection kit for simultaneous lighting of ceiling lights and Modular hood. The maximum number of connectable modules is 4 (including the Control module). Kit code 9700 646

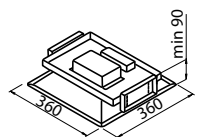

Modular Trio NEW



	Ref.	Technical Drawing
--	------	-------------------

Modular Trio

2536 000
95 cm

Ceiling suction hood
Finish: **stainless steel**
Remote control included
2 grease filters
4 speeds
LED illumination (4.000 kelvin)
Perimetric aspiration
Automatic delayed shutdown

Motors: 2
Air flow rate: **850 m³/h**
Air exhaust holes: Ø120 mm
Motor power: 2x160 W
Energy Class: D

“Filtering mode” option not available for this model

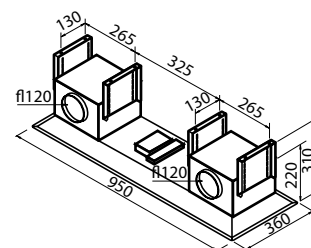

accessories:

	Ref.
silencing kit Ø 120 mm	9700 602
intake manifold for 2 pipes - in Ø120 / out Ø150 mm	2523 000
intake manifold for 3 pipes - in Ø120 / out Ø200 mm	2524 000
intake manifold for 4 pipes - in Ø120 / out Ø200 mm	2525 000

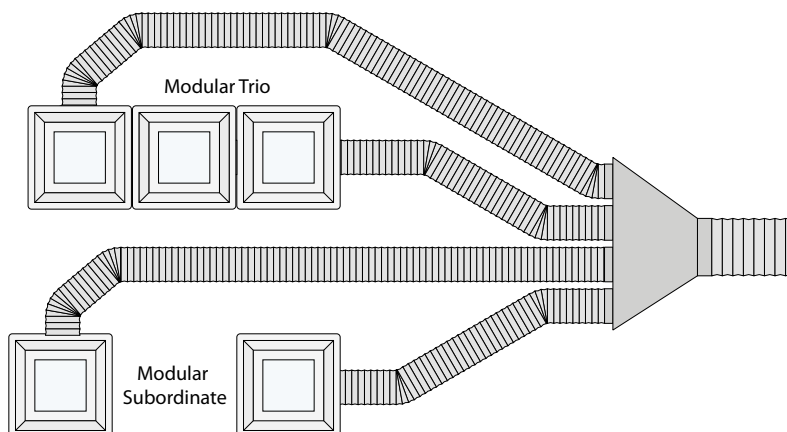

Suggestion:

The Modular TRIO hood can operate as Control module for a composition of Modular hoods (see page 187), and thus be connected in line with 2 subordinate Modular hoods.

Breeze NEW

A+
CLASS



Ref.

Technical Drawing

Breeze inox

2537 000
100 cm



Ceiling suction hood
Finish: **stainless steel**
Remote control included
3 grease filters
4 speeds
Illumination 2 LED strip (4.200 kelvin)
Perimetric aspiration
Automatic delayed shutdown
Air flow rate: **930 m³/h**
Air exhaust hole: 230x80 mm
Motor power: 85 W
Silence Plus motor
360° Swiveling motor
Easy fix
Energy Class: A+
Suspended ceiling height:
min 200 mm - max 280 mm
"Filtering mode" option not available for this model

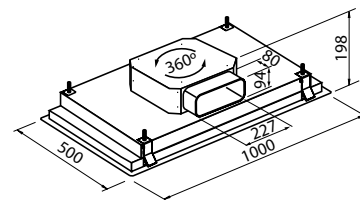

NOTE: THE HOOD CAN BE INSTALLED WITH OR WITHOUT THE LED ILLUMINATION SYSTEM, DEPENDING ON NEEDS.



Breeze white

2537 100
100 cm



Ceiling suction hood
Finish: **white enameled steel**
Remote control included
3 grease filters
4 speeds
Illumination 2 LED strip (4.200 kelvin)
Perimetric aspiration
Automatic delayed shutdown
Air flow rate: **930 m³/h**
Air exhaust hole: 230x80 mm
Motor power: 85 W
Silence Plus motor
360° Swiveling motor
Easy fix
Energy Class: A+
Suspended ceiling height:
min 200 mm - max 280 mm

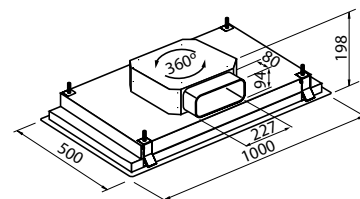

"Filtering mode" option not available for this model

NOTE: THE HOOD CAN BE INSTALLED WITH OR WITHOUT THE LED ILLUMINATION SYSTEM, DEPENDING ON NEEDS.



Cloud



	Ref.		Technical Drawing
--	------	--	-------------------

Cloud 90



2521 091
90 cm

Ceiling suction hood
Finish:
satin stainless steel - white glass
Remote control included
2 grease filters
4 speeds
4 LED illumination (4.000 kelvin)
Perimetric aspiration
Automatic delayed shutdown

Total air flow rate: **1170 m³/h**
Air exhaust hole: 230x80 mm (x2)
Double motor, power: 2x52 W
Energy Class: B

Suspended ceiling height:
min 195 mm - max 245 mm

“Filtering mode” option not available for this model

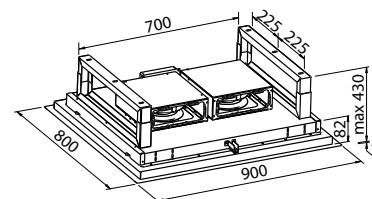

accessories:

space-saving intake manifold for 2 pipes

Ref.
2542 000

Cloud 130



2521 131
130 cm

Ceiling suction hood
Finish:
satin stainless steel - white glass
Remote control included
2 grease filters
4 speeds
6 LED illumination (4.000 kelvin)
Perimetric aspiration
Automatic delayed shutdown

Total air flow rate: **1170 m³/h**
Air exhaust hole: 230x80 mm (x2)
Double motor, power: 2x52 W
Energy Class: B

Suspended ceiling height:
min 191 mm - max 246 mm

“Filtering mode” option not available for this model

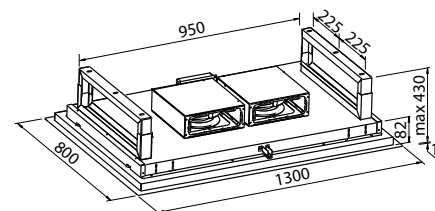

accessories:

space-saving intake manifold for 2 pipes

Ref.
2542 000

Sky



Ref.	Technical Drawing
------	-------------------

Sky 90

2522 091
90 cm

Ceiling suction hood
Finish:
satin stainless steel
Remote control included
2 grease filters
4 speeds
4 LED Design illumination (4.000 kelvin)
Perimetric aspiration
Automatic delayed shutdown

Air flow rate: **1170 m³/h**
Air exhaust hole: 230x80 mm (x2)
Motor power: 2x52 W
Energy Class: B

Suspended ceiling height:
min 195 mm - max 245 mm

“Filtering mode” option not available for this model

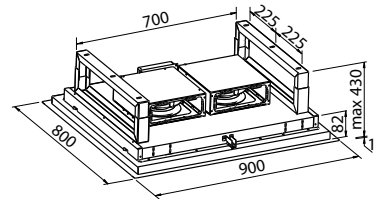

accessories:

space-saving intake manifold for 2 pipes

Ref.
2542 000

Sky 130

2522 131
130 cm

Ceiling suction hood
Finish:
satin stainless steel
Remote control included
2 grease filters
4 speeds
6 LED Design illumination (4.000 kelvin)
Perimetric aspiration
Automatic delayed shutdown

Air flow rate: **1170 m³/h**
Air exhaust hole: 230x80 mm (x2)
Motor power: 2x52 W
Energy Class: B

Suspended ceiling height:
min 191 mm - max 246 mm

“Filtering mode” option not available for this model

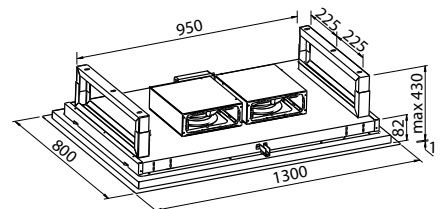

accessories:

space-saving intake manifold for 2 pipes

Ref.
2542 000

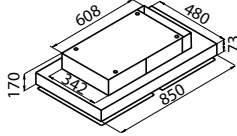

	Ref.		Technical Drawing
--	------	--	-------------------

<p>Geko</p> 	<p>2449 190 90 cm</p> <hr/> <p>Ceiling filtering hood Finish: satin stainless steel and white glass Remote control included 2 grease filters carbon filter included 4 speeds with timer Illumination 2x2,1 W LED (4.000 kelvin)</p> <p>Air flow rate: 600 m³/h</p> <p>NOTE: HOOD WITH ONLY FILTERING MODE AND NOT SUITABLE FOR COUNTERTOP SOLUTIONS.</p>	
---	---	---

	<p>accessories:</p> <p>carbon filter (spare part)</p>	<p>Ref. 9700 527</p>
--	--	--------------------------



Geko hood opening system for access to filters.

S4000 Mirror



Ref. Technical Drawing

S4000 Mirror

2444 090*
90 cm



Wall-mounted linear suction hood with telescopic chimney
 Finish: satin stainless steel - black tempered glass
Touch control
Stainless steel grease filters
 hood 90 cm: 3 filters
 hood 120 cm: 4 filters
 4 speeds
LED illumination (4.000 kelvin)
Automode function
 Automatic delayed shutdown
 Optional filtering operation mode
 Air flow rate: **700 m³/h**
 Chimney height:
 for suction mode 580 – 1010 mm
 for filtering mode 650 – 1080 mm
 Air exhaust hole: Ø 120/150 mm
 Motor power: 205 W
Energy Class: A

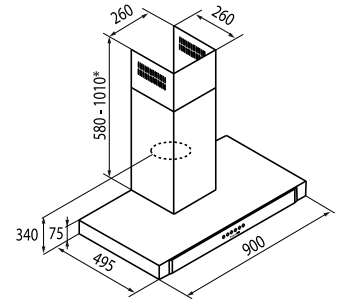

*chimney height in filtering mode is:
min 650 - max 1080

accessories:	Ref.
carbon filter	9700 517
silencing kit Ø 120	9700 602
silencing kit Ø 150	9700 603



S4000 Mirror Wing

2445 090*



Wall-mounted linear suction hood with telescopic chimney
 Finish:
 satin stainless steel - black tempered glass
Touch control
 2 grease filters
 4 speeds
LED illumination (4.000 kelvin)
Automode function
 Automatic delayed shutdown
 Optional filtering operation mode

 Air flow rate: **700 m³/h**
 Chimney height:
 for suction mode 575 – 995 mm
 for filtering mode 645 – 1065 mm
 Air exhaust hole: Ø 120/150 mm
 Motor power: 205 W
 Energy Class: B

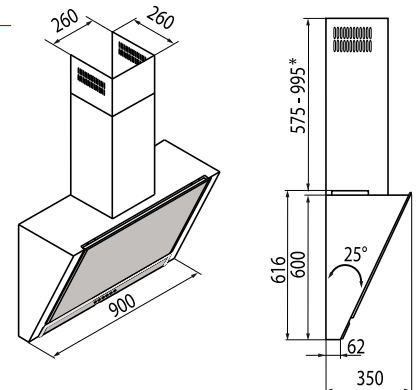

*chimney height in filtering mode is:
min 645 - max 1065

accessories:	Ref.
carbon filter	9700 516
silencing kit Ø 120	9700 602
silencing kit Ø 150	9700 603



*available until stock exhaustion



Ghost

Receding completely into the worktop, the Ghost hoods **combine functionality and performance with an essential and classy design**. The 120 version has been engineered for a perfect matching with the many in-line solutions of Foster, both gas and induction. The Domino version perfectly completes the S4000 Domino cooking range.

Ghost

Ref.

Technical Drawing

Ghost 120 Flush-mount

2451 120



Flush-mount table hood
 Finish:
satin stainless steel - black glass
Touch control
 2 grease filters
 4 speeds
 Neon illumination (6.500 kelvin)
 Automatic delayed shutdown
 Optional filtering operation mode

Air flow rate: **800 m³/h**
 Height from floor: 300 mm
 Dimensions on the worktop: 1175x120 mm
 Cut-out:
 - on-top built-in: 1142x100 mm
 - flush-mount built-in: see drawing beside
 Air exhaust hole: Ø 120/150 mm
 Motor power: 275 W
Energy Class: A

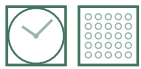
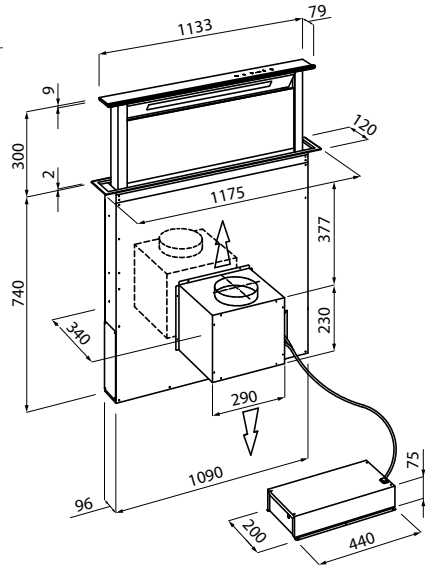

The Ghost hoods offer a great easiness of installation: the motor can be positioned frontally, on the back of the hood or detached, by means of the specific optional kit (see drawing here next)

Remote motor installation schemes

The parts in red in the drawing represent a kit for installation of the engine remotely, up to a distance of 5 meters.

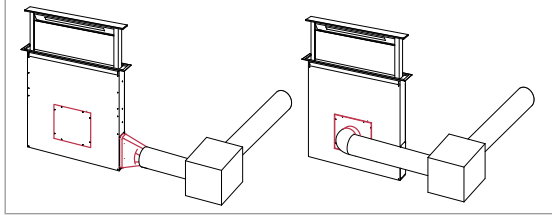

Cut-out for flush mount installation

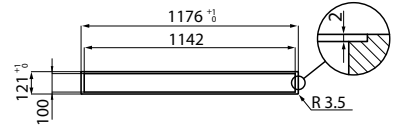

accessories:

	Ref.
2 carbon filters kit	9700 460
silencing kit Ø 120	9700 602
silencing kit Ø 150	9700 603
remote motor installation kit	9700 459

S4000 Domino Ghost

2451 000



Table-top hood
 Finish:
satin stainless steel - black glass
Touch control
Suction on both sides
 1 grease filter
 4 speeds
 Automatic delayed shutdown
 Optional filtering operation mode

Air flow rate: **800 m³/h**
 Adjustable height from table 180-300 mm
 Dimensions on the worktop: 520x120 mm
 Cut-out: 490x104 mm
 Air exhaust hole: Ø 120/150 mm
 Motor power: 275 W
 Energy Class: B

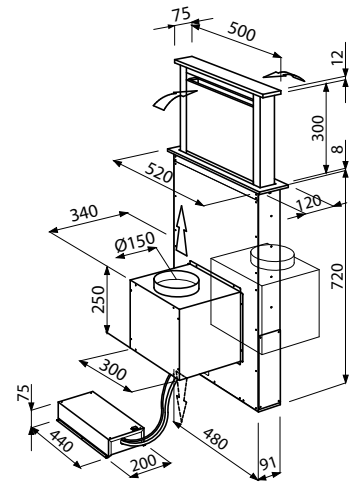

The Ghost hoods offer a great easiness of installation: the motor can be positioned frontally, on the back of the hood or detached, by means of the specific optional kit (see drawing here next)

Remote motor installation schemes

The parts in red in the drawing represent a kit for installation of the engine remotely, up to a distance of 5 meters.

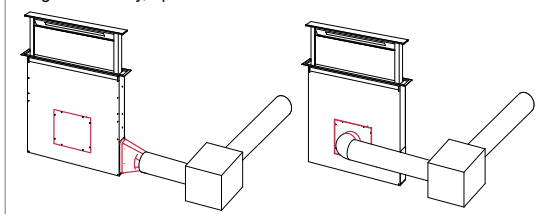

accessories:

	Ref.
2 carbon filters kit	9700 450
silencing kit Ø 120	9700 602
silencing kit Ø 150	9700 603
remote motor installation kit	9700 459

Maya



A
CLASS

Model	Ref.	Technical Drawing
-------	------	-------------------

Maya 80 wall



hood body	2500 100
telescopic chimney kit	2500 101

Wall-mounted linear suction hood with telescopic chimney
Finish:

satin stainless steel - white glass

Remote control included

2 stainless steel grease filter

4 speeds

LED illumination (3 LED x 4,8 W) - 4.000 kelvin

Automatic delayed shutdown

Air flow rate: **790 m³/h**

Air exhaust hole: Ø 120/150 mm

Motor power: 275 W

Energy Class: A

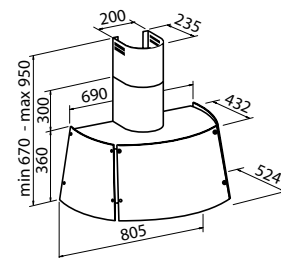

“Filtering mode” option not available for this model

accessories:

	Ref.
silencing kit Ø 120 mm	9700 602
silencing kit Ø 150 mm	9700 603



Maya 64 island



hood body	2501 100
chimney h 480 mm	2501 101
chimney h 610 mm	2501 102
chimney h 740 mm	2501 103
chimney h 990 mm	2501 104

Island suction hood

Finish: **satin stainless steel - white glass**

Remote control included

1 stainless steel grease filter

4 speeds

LED illumination (3 LED x 4,8 W) - 4.000 kelvin

Automatic delayed shutdown

Air flow rate: **790 m³/h**

Air exhaust hole: Ø 120/150 mm

Motor power: 275 W

Energy Class: A

“Filtering mode” option not available for this model

accessories:

	Ref.
silencing kit Ø 120 mm	9700 602
silencing kit Ø 150 mm	9700 603

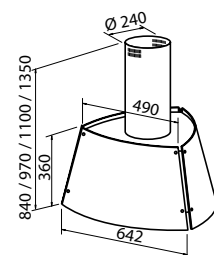

FL Slim NEW



	Model	Ref.	Technical Drawing
--	-------	------	-------------------

FL Slim black mirror

black mirror	2450 690	
hood body	90 cm	
white	2450 190	
hood body	90 cm	
telescopic chimney kit	2454 000	



FL Slim white



Wall-mounted linear suction hood with telescopic chimney (optional)
 Finish: **satín stainless steel, Black Mirror or White tempered glass**
Touch control
 5 stainless steel grease filter
 4 speeds
 Illumination 2x2,1 W LED (4.000 kelvin)
 Auto-mode functioning with temperature detector
Double aspiration: from below and front side
 Automatic delayed shutdown 5-10-20"
 Optional filtering operation mode

Air flow rate: **725 m³/h**
 Chimney height (optional):
 for suction mode: 320-500 mm
 for filtering mode: 370-560 mm
 Air exhaust hole: Ø 120/150 mm
 Motor power: 175 W
Energy Class: A

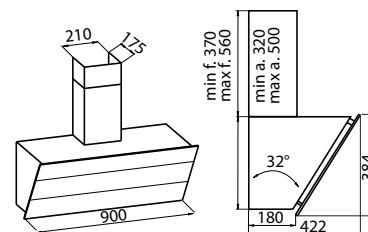

accessories:	Ref.
carbon filter	9700 524
silencing kit Ø 120	9700 602
silencing kit Ø 150	9700 603



FL SLIM IS EQUIPPED WITH A **DOUBLE SUCTION**, WITH 5 STEEL FILTERS POSITIONED BELOW AND ON THE FRONT OF THE HOOD. THE GLASS PANEL, OPENING UP, FURTHER IMPROVES THE FLOW OF AIR.



Model	Ref.	Technical Drawing
-------	------	-------------------

Stripe 90 Black Mirror



Available from July 2017

hood body	2450 090 90 cm
telescopic chimney kit	2454 000

Wall-mounted linear suction hood with telescopic chimney (optional)
 Finish: **satin stainless steel, Black Mirror tempered glass**
Touch control
 5 stainless steel grease filter
 4 speeds
 Illumination 2x2,1 W LED (4.000 kelvin)
 Auto-mode functioning with temperature detector
Double aspiration: from below and front side
 Automatic delayed shutdown 5-10-20"
 Optional filtering operation mode

Air flow rate: **725 m³/h**
 Chimney height (optional):
 for suction mode: 320-500 mm
 for filtering mode: 370-560 mm
 Air exhaust hole: Ø 120/150 mm
 Motor power: 175 W
Energy Class: A

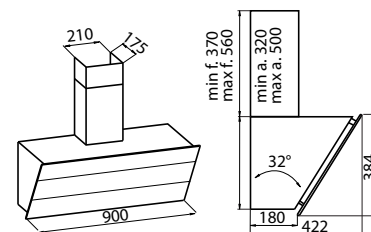

accessories:	Ref.
carbon filter	9700 524
silencing kit Ø 120	9700 602
silencing kit Ø 150	9700 603



STRIPE HOOD IS EQUIPPED WITH A **DOUBLE SUCTION**, WITH 5 STEEL FILTERS POSITIONED BELOW AND ON THE FRONT OF THE HOOD. THE GLASS PANEL, OPENING UP, FURTHER IMPROVES THE FLOW OF AIR.



Stripe oven see page 179

Q inox



	Ref.		Technical Drawing
--	------	--	-------------------

Q inox wall

2510 060
60 cm

2510 090
90 cm



Wall-mounted linear suction hood
Finish:
satin stainless steel
Easy electronic control
Stainless steel grease filters
hood 60 cm: 1 filter
hood 90 cm: 2 filters
4 speeds
LED illumination (4.000 kelvin)
Automatic delayed shutdown
Optional filtering operation mode

Air flow rate: **790 m³/h**
Air exhaust hole: Ø 120/150 mm
Motor power: 275 W
Energy Class: A

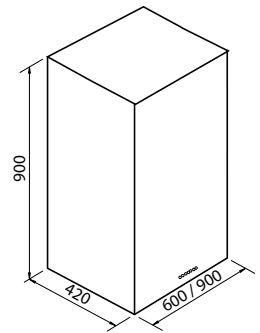

accessories:

	Ref.
carbon filter	9700 601
silencing kit Ø 120	9700 602
silencing kit Ø 150	9700 603

Q inox island

2511 060
60 cm

2511 090
90 cm



Island suction hood with telescopic chimney
Finish:
satin stainless steel
Easy electronic control
Stainless steel grease filters
hood 60 cm: 1 filter
hood 90 cm: 2 filters
4 speeds
LED illumination (4.000 kelvin)
Automatic delayed shutdown
Optional filtering operation mode

Air flow rate: **790 m³/h**
Chimney height: 200-700 mm
Air exhaust hole: Ø 120/150 mm
Motor power: 275 W
Energy Class: B

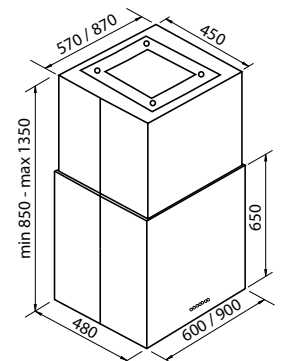

accessories:

	Ref.
carbon filter	9700 601
silencing kit Ø 120	9700 602
silencing kit Ø 150	9700 603

Master NEW



Ref.	Technical Drawing
------	-------------------

Master wall



Available from July 2017



2505 094	90 cm
2505 124	120 cm

Wall-mounted suction hood with telescopic chimney
 Finish: satin stainless steel
Touch slider Electronic control
Stainless steel grease filters
 8 plus 2 intensive timed speeds
LED Design illumination (4.000 kelvin)
 90 cm hood: n. 2 Led - 120 cm hood: n. 3 Led
Filter saturation warning light
 Optional filtering operation mode
 Grease filters number:
 90 cm hood: 3 filters - 120 cm hood: 4 filters
 Air flow rate: **700 m³/h**
 Chimney height:
 for suction mode 630 – 1050 mm
 for filtering mode 700 – 1120 mm
 Air exhaust hole: Ø 120/150 mm
EBM Brushless motor, power 170 W
Energy Class: A+

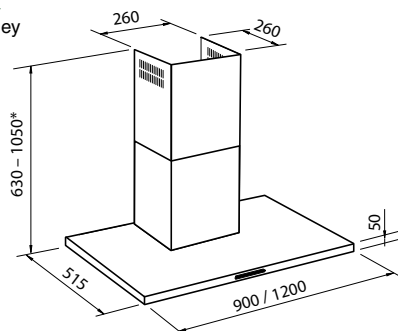

*chimney height in filtering mode is:
min 700 - max 1120

accessories:	Ref.
carbon filter	9700 528
silencing kit Ø 120	9700 602
silencing kit Ø 150	9700 603

Master island



Available from July 2017



2506 094	90 cm
2506 124	120 cm

Island suction hood with telescopic chimney
 Finish: satin stainless steel
Touch slider Electronic control
Stainless steel grease filters
 8 plus 2 intensive timed speeds
LED Design illumination (4.000 kelvin)
 (n. 4 LED)
Filter saturation warning light
 Optional filtering operation mode

 Air flow rate: **700 m³/h**
 Chimney height:
 for suction mode 840 – 1030 mm
 for filtering mode 840 – 1140 mm

 Air exhaust hole: Ø 120/150 mm
EBM Brushless motor, power 170 W
Energy Class: A+

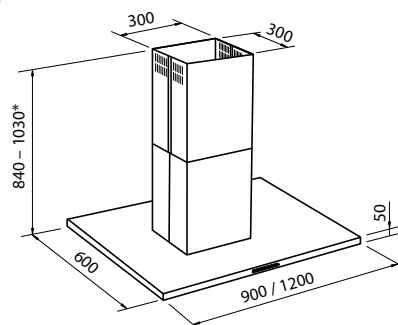

*chimney height in filtering mode is:
min 700 - max 1120

accessories:	Ref.
carbon filter	9700 528
silencing kit Ø 120	9700 602
silencing kit Ø 150	9700 603



	Ref.	Technical Drawing
--	------	-------------------

KS Lux

2504 064 60 cm
2504 094 90 cm
2504 124 120 cm

Technical Drawing



Available from July 2017

Wall-mounted linear suction hood with telescopic chimney
 Finish: satin stainless steel
 Electronic control
Stainless steel grease filters

Auto-mode functioning with temperature detector
 3 plus 1 intensive timed speeds
 LED illumination (4.000 kelvin)
 60 cm hood: n. 2 Led
 90 cm hood: n. 2 Led
 120 cm hood: n. 3 Led

Automatic delayed shutdown
 Optional filtering operation mode
 60 cm hood: n. 2 grease filters
 90 cm hood: n. 3 grease filters
 120 cm hood: n. 4 grease filters

Air flow rate: **700 m³/h**
 Chimney height:
 for suction mode 630 – 1050 mm
 for filtering mode 700 – 1120 mm
 Air exhaust hole: Ø 120/150 mm
 Motor power: 250 W
Energy Class: A

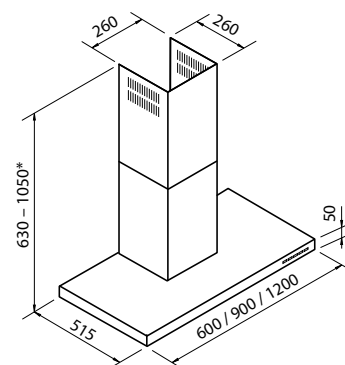

*chimney height in filtering mode is:
 min 700 - max 1120

accessories:

	Ref.
carbon filter	9700 528
silencing kit Ø 120	9700 602
silencing kit Ø 150	9700 603





	Ref.	Technical Drawing
--	------	-------------------

KS 90

2409 001

Wall-mounted linear suction hood
with telescopic chimney
Finish:
satin stainless steel
Mechanical push-button control
3 grease filters
3 speeds
LED illumination (4.000 kelvin)
Optional filtering operation mode

Air flow rate: **600 m³/h**
Chimney height: 490 – 840 mm
Air exhaust hole: Ø 120/150 mm
Motor power: 230 W
Energy Class: A

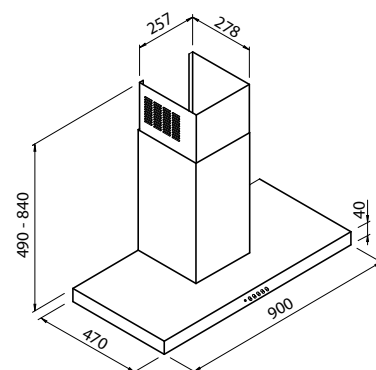

accessories:

	Ref.
carbon filter	9700 402
silencing kit Ø 120	9700 602
silencing kit Ø 150	9700 603



Sunset NEW



A
CLASS

Sunset	Ref.	Technical Drawing
--------	------	-------------------

Sunset

2446 090
90 cm



Wall-mounted linear suction hood
with telescopic chimney
Finish: satin stainless steel and glass
Soft touch control
1 grease filter
4 speeds
Illumination 2x2,1 W LED (4.000 kelvin)
Automatic delayed shutdown
Optional filtering operation mode

Air flow rate: **620 m³/h**
Chimney height:
for suction mode: 575-995 mm
for filtering mode: 645-1065 mm
Air exhaust hole: Ø 120/150 mm
Energy Class: A

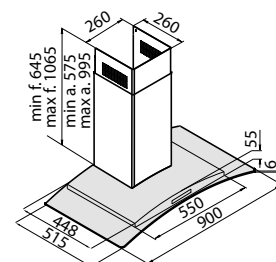

accessories:

	Ref.
carbon filter	9700 517
silencing kit Ø 120	9700 602
silencing kit Ø 150	9700 603





CLASS

	Ref.	Technical Drawing
--	------	-------------------

Amélie

2447 090
90 cm



Wall-mounted linear suction hood
with telescopic chimney
Finish: satin stainless steel
Soft touch control
3 grease filters
3 speeds
Illumination 2x2,1 W LED (4.000 kelvin)
Optional filtering operation mode

Air flow rate: **620 m³/h**
Chimney height:
for suction mode: 580-1000 mm
for filtering mode: 650-1070 mm
Air exhaust hole: Ø 120/150 mm
Energy Class: A

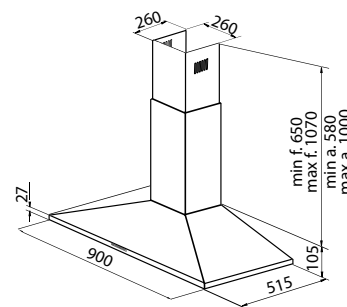

accessories:	Ref.
carbon filter	9700 517
silencing kit Ø 120	9700 602
silencing kit Ø 150	9700 603

Wing Space NEW



	Ref.	Technical Drawing
--	------	-------------------

Wing Space

2534 090
90 cm



Built-in suction hood with stainless steel telescopic chimney and box motor cover included
 Finish:
stainless steel e glass
Remote control included
 2 grease filters
 4 speeds
LED illumination (4.000 kelvin)
Perimetric aspiration
 Automatic delayed shutdown
 Profiles for cabinet protection in stainless steel
 Filter saturation warning
 Air flow rate: **800 m³/h**
 Air exhaust hole: Ø150 mm
 Motor power: 275 W
space-saving system with motor fixed at the top of cabinet
Energy Class: A
Optional filtering operation mode with carbon filters

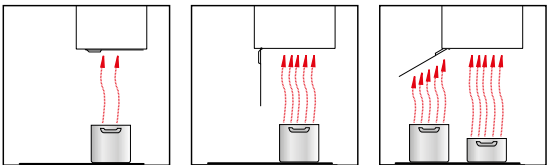
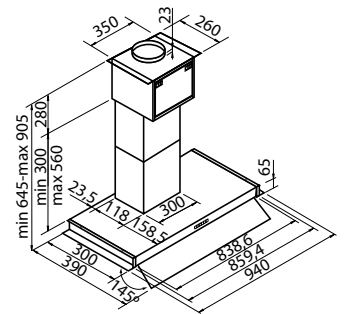

accessories:	Ref.
carbon filters kit	9700 601
silencing kit Ø 120	9700 602
silencing kit Ø 150	9700 603



Space-saving system
 The motor of Wing Space hood is positioned in the upper part of the cabinet, with a considerable saving of space compared to a traditional solution.



Top of the hood view

Wing



Ref.	Technical Drawing
------	-------------------

Wing	2512 061
	60 cm
Wing	2512 091
	90 cm



Under-cabinet built-in suction hood
 optional stainless steel telescopic chimney
 and box motor cover
 Finish: satin stainless steel / glass
Remote control included
 Easy electronic control
 Aluminium grease filters
 hood 60 cm: 1 filter
 hood 90 cm: 1 filter
 4 speeds
 2 LED illumination (4.000 kelvin)

Automatic delayed shutdown
Perimetric aspiration
Stainless steel protection profiles for the hanging cabinets
 Optional filtering operation mode
 Saturation filters warning

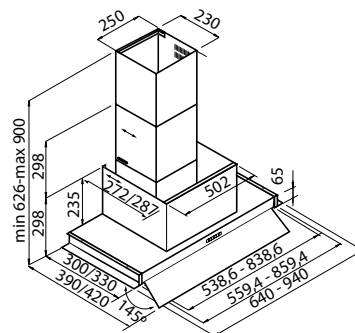

Air flow rate: **830 m³/h**
 Air exhaust hole: Ø 150 mm
 Motor power: 275 W
Energy Class: A

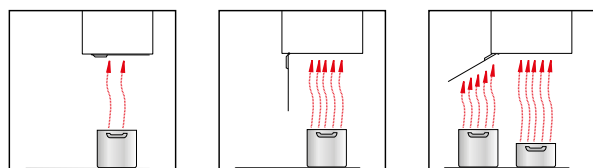

accessories:	Ref.
carbon filters kit	9700 601
silencing kit Ø 120	9700 602
silencing kit Ø 150	9700 603
stainless steel telescopic chimney	2539 000
stainless steel box motor cover	2539 100



Garage

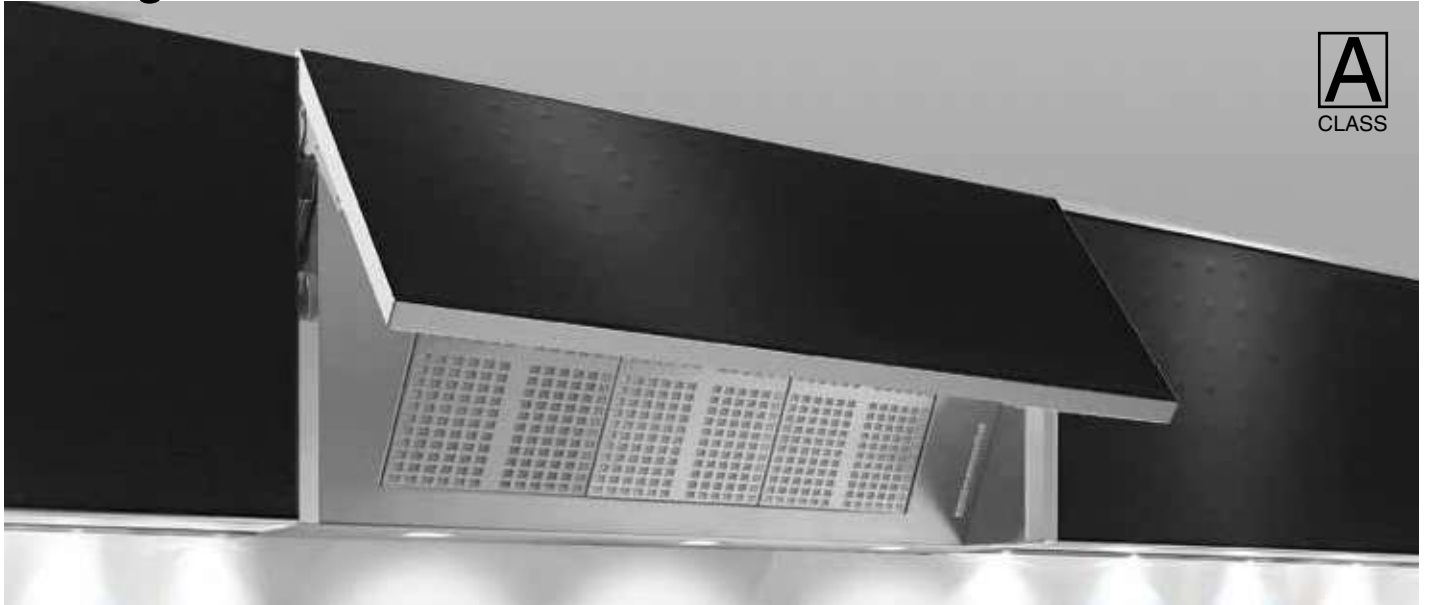

Ref.			
------	--	--	--

Garage

	60 cm	2515 060
	90 cm	2515 090
	120 cm	2515 120



Fully-hidden wall suction hood
 Finish: satin stainless steel
 Easy electronic control
Stainless steel grease filters
 hood 60 cm: 1 filter
 hood 90 cm: 3 filters
 hood 120 cm: 4 filters
 4 speeds
 LED illumination (4.000 kelvin)

Automatic delayed shutdown
Blum hinge with soft-closing mechanism
Rear exit mode function
 Balanced suction system
 Optional filtering operation mode

Air flow rate: **800 m³/h**
 Air exhaust hole: Ø 120/150 mm
 Motor power: 275 W
Energy Class: A

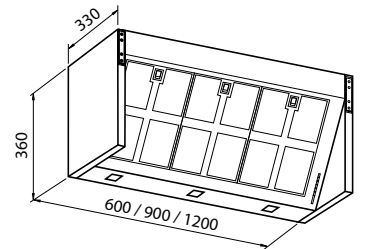

THE HOOD IS TO BE FIXED TO THE WALL.
 IT IS INSTALLED IN PLACE
 OF THE SUSPENDED CABINET.

Balanced Suction System

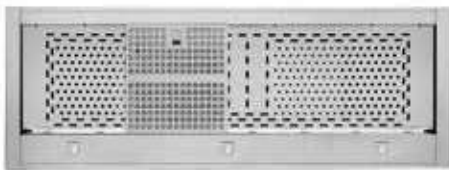

Available stainless steel side panels
 for end-composition installation



accessories:	Ref.
carbon filters kit	9700 601
silencing kit Ø 120	9700 602
silencing kit Ø 150	9700 603

length \ height	60 cm	90 cm	120 cm
	36 cm	4,2 ÷ 13,6 Kg	4,2 ÷ 13,6 Kg

Garage hoods feature renowned amortized Blum hinges.

The chart aside shows min and max weights of the wing recommended for a proper functioning of the mechanism.



Flat



	Ref.	Technical Drawing
--	------	-------------------



The hood is to be fixed to the shoulders of the hanging cabinet

white	2513 161	60 cm
	2513 191	90 cm
	2513 121	120 cm
black	2513 661	60 cm
	2513 691	90 cm
		90 cm

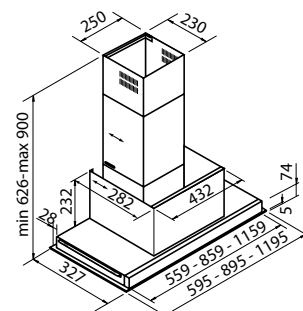

* telescopic chimney and box motor cover are optional fittings

Under-cabinet built-in suction hood
 Optional stainless steel telescopic chimney and box motor cover
Finish: white/black glass
 Touch control
 Grease filter
 60 cm hoods: 1 filter
 90 cm hoods: 2 filters
 120 cm hood: 4 filters

4 speeds
LED stripe illumination (4.200 kelvin)
 Automatic delayed shutdown
Perimetric aspiration
 Optional filtering operation mode
 Air flow rate: **750 m³/h**
 Air exhaust hole: Ø 120/150 mm
 Motor power: 275 W
Energy class: A



The hood is to be fixed to the shoulders of the hanging cabinet

Flat inox	2513 061	60 cm
	2513 091	90 cm
	2513 021	120 cm

Under-cabinet built-in suction hood
 Optional stainless steel telescopic chimney and box motor cover
 Finish: satin stainless steel
Remote control included
 Easy electronic control
 Grease filter: 60 cm hoods: 1 filter
 90 cm hoods: 2 filters - 120 cm hood: 4 filters
 4 speeds
LED stripe illumination (4.200 kelvin)
 Automatic delayed shutdown
Perimetric aspiration
 Optional filtering operation mode
 Air flow rate: **750 m³/h**
 Air exhaust hole: Ø 120/150 mm
 Motor power: 275 W
Energy class: A

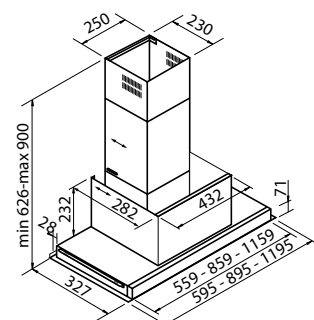

* telescopic chimney and box motor cover are optional fittings

Flat hoods accessories:	Ref.
carbon filter	9700 600
silencing kit Ø 120	9700 602
silencing kit Ø 150	9700 603
stainless steel telescopic chimney	2539 000
box copromotore inox	2539 200

Pitagora



Ref.

Technical Drawing

Pitagora 90x90

2439 002



Corner suction hood with telescopic chimney section
 Finish:
 satin stainless steel
 Minimal electronic control
 2 grease filters
 4 speeds
 LED illumination (2x1,2 W) - 4.000 kelvin
 Automatic delayed shutdown
 Optional filtering operation mode

Air flow rate: **800 m³/h**
 Chimney height: 450 – 850 mm
 Air exhaust hole: Ø 150 mm
 Motor power: 250 W
Energy Class: A

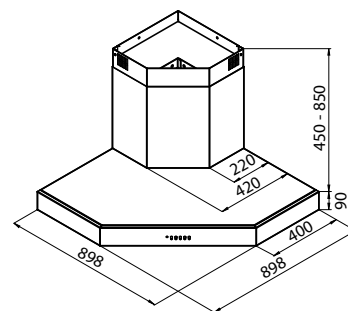

accessories:

	Ref.
carbon filter	9700 409
silencing kit Ø 120	9700 602
silencing kit Ø 150	9700 603



Refrigerators

The new built-in range brings the Foster philosophy into refrigerating products: excellence in performance accompanied by great functionality and meticulous attention to the smallest detail.



High efficiency

Foster refrigerators ensure high performance and great power efficiency. The entire range complies to A++ and A+ energy saving requirements, with consumptions reduced by 40% and 25% compared to the standard A Class. An important contribution to savings in full compliance with environmental protection.



No frost

The No-Frost technology removes moisture from the freezer with a forced ventilation system in controlled temperature and humidity conditions. No more ice that reduces the usable volume, glues packings one to the other and compromises performance. The system is full automatic and doesn't require unpractical manual defrosting operations.



Ventilated cooling system

The ventilation of the refrigerator area allows a perfect homogeneity of cooling and improves the preservation of food, ensuring that it remains longer fresh. The system also avoids the formation of odours and condensation on the walls, without changing the internal humidity which prevents the food, especially the fresh ones, from drying in a short time.



Climate classes

"Tropical" models offer the most extensive adaptability to climatic conditions and temperatures, while maintaining a high efficiency and optimal consumption. They are in fact approved for all climate classes SN, N, ST, T, with a range of suitable temperatures from 10° C to 43° C.

Features



LED digital display

The electronic control of the functions allows for accurate programming of the desired temperatures, both in the freezer and refrigerator compartments.

LED lighting

The No-frost model features an internal LED lighting system, with a greatly improved brightness and a consumption 4 times lower than the one of traditional lighting.

Holiday function

This function turns off only the refrigerator compartment. It is thus possible to leave for the holidays without fears: the system will avoid all unnecessary consumption of energy without having to empty the freezer.

Fast freeze & Super cool

These functions are available on models with digital programming; they respectively allow the freezing and quick cooling of large quantities of food.

Door and temperature alarm

It prevents unnecessary consumption of food and energy in case of oversights or malfunction of the machine. An acoustic alarm and a warning light on the display indicate either the non-latching of the door, or an abnormal increase in the internal temperature.



Fresh zone

The special Fresh Zone drawer is an ideal storage area for fresh food, be it meat or fruit and vegetables, significantly increasing their period of preservation. The ventilation of the refrigerator compartment is channelled directly into the drawer, thus maintaining a constant temperature between 0° and 5° C.

Classy details

The outfit of all Foster refrigerators is finished with the utmost care and endowed with classy details and many solutions to optimize the use of space.



Wine rack

The stylish stainless steel bottle holder makes it easier to chill the drinks with a minimal use of space. The slightly tilted shape can easily accommodate also previously opened bottles.



Half shelves

The upper level is outfitted with two distinct shelves which can be positioned in different ways according to need. The space is thus optimized without losing the possibility to store large containers.



Stainless steel details

The No-Frost model has been the object of a particular care for every small detail in looks and finish. The shelves and bottle holder sport a premium stainless-steel finish.

Refrigerators

Model

Ref.

Technical Drawing

Built-in integrated refrigerator

2034 000



Energy class: A++

No-Frost Freezer

Ventilated refrigerator

Total gross capacity: 279 lt
 Electronic control with LED display
 Double alarm: open door / temperature
 Reversible door - standard hinges on the right
 size: 540x1770 mm
 Climate class: SN/T (tropical +10°C / +43°C)
 Annual energy consumption: 230 kWh
 Freezing capacity: 7.5 kg / 24h
 Power supply: 220-230V - 50Hz

Refrigerator

Fridge net capacity: 200 lt
 Automatic defrost
 Super-Cool quick cooling function
 LED Lighting
 Fresh-Zone drawer
 Stainless steel wine rack
 4 glass shelves
 1 sectioned shelf
 2 fruit & vegetable drawers
 4 door shelves
 1 egg holder (x12)

Freezer

Freezer net capacity: 62 lt *** ** ** ***
 Automatic defrost
 Fast-Freeze function
 1 drawer for fast freezing
 2 drawer for foods storage
 1 ice cube container

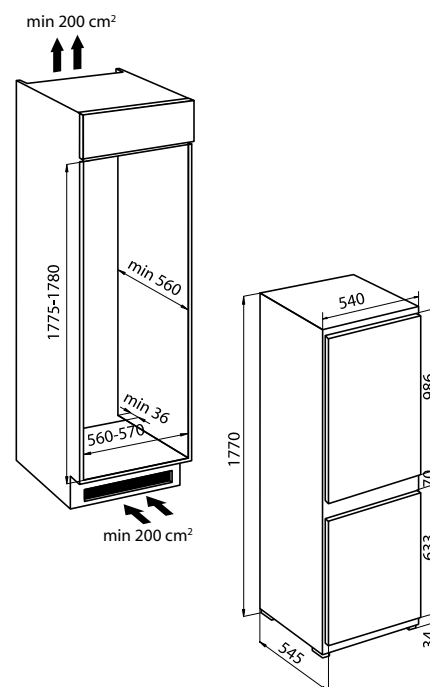

Built-in integrated refrigerator

2033 000



Energy class: A+

Ventilated refrigerator

Total gross capacity: 285 lt
 Reversible door - standard hinges on the right
 size: 540x1770 mm
 Climate class: SN/T (tropical +10°C / +43°C)
 Annual energy consumption: 306 kWh
 Freezing capacity: 5.0 kg / 24h
 Power supply: 220-230V - 50Hz

Refrigerator

Fridge net capacity: 203 lt
 Automatic defrost
 Super-Cool quick cooling function
 LED Lighting
 Stainless steel wine rack
 5 glass shelves
 1 sectioned shelf
 2 fruit & vegetable drawers
 4 door shelves
 1 egg holder (x12)

Freezer

Freezer net capacity: 70 lt *** ** ** ***
 1 drawer for fast freezing
 2 drawer for foods storage
 1 ice cube container

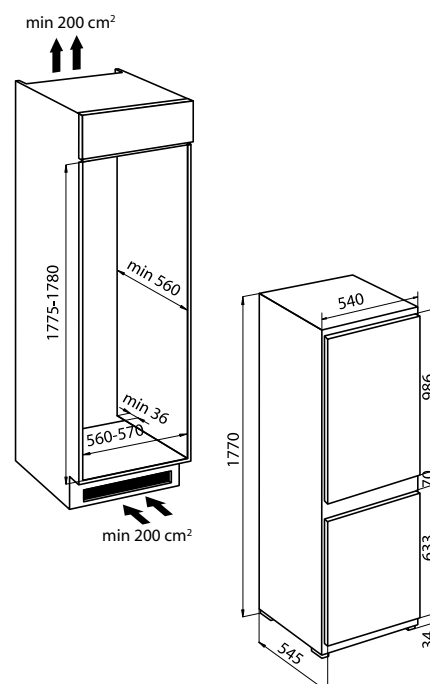

Refrigerators

Model

Ref.

Technical Drawing

Refrigerator with freezing compartment

2031 000

Energy class: A+

Total gross capacity: 232 lt
 Reversible door - standard hinges on the right
 size: 540x1445 mm
 Climate class: N/ST (subtropical + 16°C/+38°C)
 Annual energy consumption: 263 kWh
 Freezing capacity: 2.5 kg / 24h
 Power supply: 220-230V - 50Hz

Refrigerator

Fridge net capacity: 183 lt
 Automatic defrost
 3 glass shelves
 2 fruit & vegetable drawers
 3 door shelves
 1 egg holder (x6)

Freezer

Freezer net capacity: 49 lt *******
 Fast freezing function
 1 wire shelf
 1 ice cube container

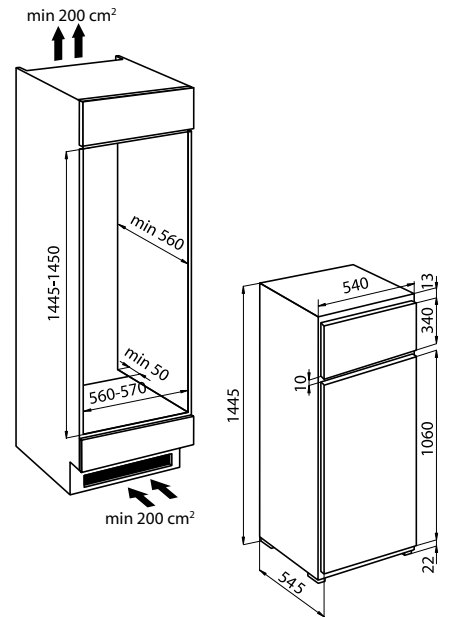

Item available until stock lasts



How to clean steel

Stainless steel products do not need any particular servicing. However, they do require a certain care and use of adequate detergents for daily cleaning. By and large, **all that's needed is to wash with hot water and soap or hot water and vinegar**, and thoroughly rinse and dry with a cloth. Do not use: hydrochloric acid, abrasive powders, steel wool, brushes and products for cleaning silver.

When it comes to detergents for cleaning steel, Foster recommends the products in the "Steel Clean" line:

- **all-purpose aerosol** for daily cleaning use
- **microfiber cloth** to wipe off traces of grease and powder.
- **professional cream** to restore the original splendour of the steel, remove scaling, stubborn dirt and rust marks caused by contact with ferrous materials.



Steel Clean - cream
Detergent cream for stainless steel

250 ml bottle

Ref.		
8331 000		

pack of 12 pcs.

Ref.		
8331 012		



Steel Clean - microfiber
Microfiber cloths for cleaning stainless steel

pack of 3 pcs.

Ref.		
8333 000		

12 pack of 3 pcs.

Ref.		
8333 012		



Steel Clean - all-purpose
All-purpose detergent with vaporizer

500 ml bottle

Ref.		
8332 000		

pack of 12 pcs.

Ref.		
8332 012		



Steel Clean - kit
Steel cleaning kit containing:
- 1 bottle containing 250 ml of cream
- 1 bottle containing 500 ml of all-purpose fluid
- 1 pack of 3 microfiber cloths

cleaning kit

Ref.		
8339 000		

Research by code

code	page	code	page	code	page	code	page	code	page	code	page
1010 000	57	1218 097	26	1410 000	15	2154 850	74	2501 101	196	2999 000	168
1010 008	85	1218 850	66	1412 000	15	2155 850	74	2501 102	196	3121 060	20
1010 060	57	1218 897	67	1414 001/2	15	2155 856	76	2501 103	196	3123 060	20
1010 068	85	1219 050	24	1416 001/2	14	2155 858	79	2501 104	196	3124 060	19
1011 050	13	1220 050	23	1418 000	14	2155 859	78	2504 064	201	3125 060	19
1012 050	13	1222 000	27	1420 001/2	14	2156 850	74	2504 094	201	3126 060	20
1013 850	64	1228 051/2	24	1485 061/2	33	2156 856	77	2504 124	201	3127 060	19
1014 850	64	1229 050	24	1488 861/2	80	2156 858	79	2505 094	200	3154 000	119
1015 850	63	1241 050	26	1490 060	33	2156 859	78	2505 124	200	3162 000	119
1016 850	63	1243 050	25	1490 860	80	2157 850	73	2506 094	200	3164 000	119
1017 050	13	1246 091/2	25	1511 002	48	2157 856	76	2506 124	200	3166 000	118
1018 050	13	1250 050	24	1512 201/2	47	2157 858	79	2510 060	199	3167 000	118
1019 050	13	1250 051/2	28	1512 401/2	47	2157 859	78	2510 090	199	3307 060	55
1020 050	13	1250 052/2	28	1513 201/2	47	2163 061/2	39	2511 060	199	3308 060	55
1024 050	13	1251 051/2	28	1555 070	54	2163 461/2	39	2511 090	199	3312 062	56
1054 600	52	1251 052	28	1555 600	52	2180 061/2	40	2512 061	206	3321 060	56
1054 609	52	1252 051/2	28	1555 609	52	2180 461/2	40	2512 091	206	4312 051/2	21
1055 600	52	1260 850	71	1561 201/2	48	2181 061/2	40	2513 021	208	4315 051/2	21
1055 609	52	1262 850	71	1561 401/2	48	2182 060	39	2513 061	208	4315 052/2	21
1071 061/2	48	1263 850	70	1562 001/2	47	2182 460	39	2513 091	208	4365 051/2	21
1072 061/2	47	1265 850	70	1579 660	53	2201 851/2	73	2513 121	208	4382 050	21
1076 061/2	47	1266 850	70	1579 670	54	2202 851/2	73	2513 161	208	4383 051/2	22
1078 660	53	1279 060	59	1611 060	49	2203 850	73	2513 191	208	4385 050	21
1079 660	53	1281 001/2	51	1611 068	83	2204 851/2	73	2513 661	208	4386 051/2	22
1110 060	57	1283 001/2	50	1661 201/2	49	2205 850	72	2513 691	208	4416 061/2	18
1114 061/2	36	1284 001/2	50	1662 001/2	49	2206 850	72	2515 060	207	4417 061/2	18
1114 062/2	36	1300 068	83	1679 660	53	2207 850	72	2515 090	207	4483 061/2	18
1114 861/2	81	1302 860	81	1679 860	84	2211 051/2	30	2515 120	207	4486 061/2	18
1116 061/2	36	1307 860	82	1811 050	83	2222 051/2	30	2518 001	187	5186 061/2	44
1116 062/2	36	1308 861/2	82	1812 161/2	58	2263 051/2	30	2519 001	187	5197 061/2	43
1116 861/2	81	1309 861/2	81	1812 461/2	58	2274 050	32	2520 001	187	5812 061/2	43
1117 061/2	36	1312 061/2	34	1886 160	59	2278 050	32	2521 091	190	5886 060	43
1117 062/2	36	1315 061/2	34	1886 460	59	2279 050	32	2521 131	190	7038 052	140
1117 861/2	81	1318 061/2	34	1962 060	50	2280 051/2	31	2522 091	191	7052 022	141
1129 000	59	1351 061/2	42	1970 860	85	2281 051/2	31	2522 131	191	7052 442	141
1144 001/2	59	1352 060	41	1971 061/2	46	2283 050	31	2523 000	186	7053 062	136
1144 061 /2	59	1353 061/2	41	1971 461/2	46	2287 050	31	2524 000	186	7055 062	136
1179 061/2	59	1354 061/2	41	1972 061/2	45	2297 051/2	31	2525 000	186	7055 462	136
1180 150	60	1363 061/2	34	1972 461/2	45	2303 890	69	2534 090	205	7058 072	134
1186 161/2	58	1372 060	35	1973 061/2	45	2304 890	68	2536 000	188	7063 042	138
1186 461/2	58	1381 061/2	35	1973 461/2	45	2305 890	68	2537 000	189	7064 062	139
1197 161/2	58	1382 062	34	1974 060	45	2307 890	68	2537 100	189	7066 052	138
1197 461/2	58	1384 061	35	1974 460	45	2409 001	202	2539 000	206	7067 062	138
1202 850	67	1384 062	35	1974 860	85	2439 002	209	2539 100	206	7068 042	139
1205 050	25	1385 062	34	1975 961/2	38	2444 090	193	2539 200	208	7103 180	171
1208 050	24	1387 061/2	35	1976 960	37	2445 090	193	2542 000	186	7103 680	171
1208 850	66	1388 062	34	1977 961/2	37	2446 090	203	2910 003	109	7104 000	177
1209 050	24	1401 000	16	1978 961/2	37	2447 090	204	2910 016	109	7104 020	174
1210 050	23	1401 100	16	2031 000	213	2449 190	192	2930 000	108	7104 100	172
1210 850	66	1401 800	65	2033 000	212	2450 090	198	2941 000	110	7104 120	171
1213 051/2	23	1402 000	16	2034 000	212	2450 190	197	2950 000	110	7104 600	172
1214 050	25	1402 080	16	2112 061/2	39	2450 690	197	2960 000	109	7104 620	171
1214 850	67	1402 100	16	2112 461/2	39	2451 000	195	2975 060	29	7105 042	174
1215 050	25	1403 000	16	2151 850	75	2451 120	195	2976 060	29	7105 142	170
1215 850	66	1403 100	16	2151 856	77	2454 000	197	2977 060	29	7105 642	170
1216 050	25	1403 800	65	2152 850	74	2500 100	196	2980 600	173	7106 643	169
1217 850	66	1404 880	65	2153 850	74	2500 101	196	2998 100	172	7107 042	174
1218 050	24	1405 800	65	2153 856	77	2501 100	196	2998 600	172	7107 142	170

Research by code

code	page	code	page	code	page	code	page	code	page	code	page
7107 642	170	7284 032	123	7624 032	133	8210 008	160	8452 000	101	8644 101	12
7111 042	179	7285 032	123	7625 032	120	8211 000	160	8454 000	97	8646 000	35
7120 054	178	7286 032	124	7625 082	120	8212 000	160	8456 000	98	8647 000	35
7122 051	178	7311 240	150	7626 032	120	8213 000	160	8458 000	103	8655 000	40
7123 040	178	7316 000	159	7627 032	120	8320 000	155	8459 000	104	8656 001	17
7126 047	177	7321 240	153	7628 032	120	8331 000	214	8466 000	100	8657 001	15
7131 053	167	7322 234	151	7636 000	117	8331 012	214	8466 100	100	8659 111	54
7134 043	166	7322 240	153	7637 000	117	8332 000	214	8467 000	97	8659 112	52
7135 080	167	7322 300	152	7638 000	117	8332 012	214	8468 000	98	8659 113	29
7136 020	167	7325 445	154	7639 000	117	8333 000	214	8469 000	95	8669 000	87
7138 000	167	7326 000	154	7640 000	117	8333 012	214	8469 020	95	8669 001	87
7139 043	166	7330 241	149	7646 000	117	8339 000	214	8469 040	95	8669 002	87
7141 042	176	7330 245	148	7647 000	117	8401 000	87	8471 000	99	8669 003	87
7142 043	176	7331 231	151	7648 000	117	8401 001	87	8472 000	97	8669 004	87
7143 044	176	7332 240	150	7649 000	117	8402 000	87	8476 000	104	8669 008	87
7146 020	176	7334 240	150	7650 000	117	8403 000	87	8477 100	96	8669 009	87
7151 000	180	7341 245	154	8000 010	91	8403 001	87	8478 000	99	8669 011	87
7162 052	175	7361 270	158	8000 011	90	8403 003	87	8479 100	98	8669 012	87
7167 052	175	7361 275	158	8000 012	90	8403 008	87	8480 000	97	8700 007	87
7170 052	180	7362 300	158	8000 014	90	8403 300	87	8481 000	105	8700 062	87
7170 062	177	7362 305	158	8000 110	91	8403 301	87	8482 000	101	8700 080	87
7191 061	178	7363 350	158	8000 113	91	8403 303	87	8483 001	100	8800 012	163
7201 032	127	7363 355	158	8000 115	91	8403 308	87	8484 000	96	8800 016	163
7202 032	127	7367 032	137	8000 214	90	8403 309	87	8485 000	103	8801 000	163
7203 032	128	7368 020	157	8100 051	27	8403 310	87	8486 000	100	9401 187	163
7204 032	128	7368 025	157	8100 111	54	8403 311	87	8487 000	96	9401 506	163
7205 032	127	7368 030	157	8100 112	52	8403 312	87	8488 000	95	9401 549	163
7206 032	127	7368 035	157	8100 112	54	8403 315	87	8490 000	104	9601 480	131
7206 082	127	7368 040	157	8100 115	35	8404 000	87	8491 010	99	9601 668	114
7206 082	127	7368 045	157	8100 151	27	8407 000	86	8492 000	99	9601 727	114
7207 032	128	7369 020	157	8100 154	15	8407 100	86	8493 000	98	9601 741	114
7208 032	128	7369 030	157	8100 201	15	8407 102	86	8496 100	100	9601 742	114
7209 032	128	7369 040	157	8100 280	49	8407 103	86	8497 000	102	9700 402	202
7235 042	126	7370 231	151	8100 301	35	8407 108	86	8497 020	101	9700 409	209
7238 042	126	7370 245	148	8100 303	13	8407 108	65	8497 400	102	9700 450	195
7243 062	136	7370 300	152	8100 304	29	8407 109	86	8497 700	102	9700 459	195
7244 062	136	7371 300	152	8100 305	60	8407 110	77	8497 856	102	9700 460	195
7245 062	136	7372 141	149	8100 331	55	8407 113	86	8498 856	101	9700 516	193
7246 062	136	7372 241	149	8100 600	13	8407 115	13	8520 000	106	9700 517	193
7250 032	124	7390 245	148	8113 800	88	8407 200	87	8520 010	106	9700 524	197
7251 032	122	7391 245	147	8118 006	87	8410 000	87	8520 100	106	9700 526	203
7252 032	121	7600 032	129	8119 000	88	8411 000	87	8520 856	106	9700 527	192
7253 032	122	7600 132	131	8141 000	89	8415 000	87	8530 000	106	9700 600	200
7254 032	124	7600 632	130	8142 000	89	8416 000	87	8611 000	26	9700 600	208
7256 032	122	7601 032	129	8143 000	89	8433 000	87	8612 000	15	9700 601	199
7256 032	122	7602 032	129	8144 000	89	8435 000	87	8612 100	15	9700 602	186
7257 032	121	7602 432	129	8145 000	89	8435 001	87	8631 300	12	9700 603	193
7258 032	122	7603 032	129	8151 000	13	8435 002	87	8633 300	26	9700 604	200
7259 032	124	7603 432	129	8151 100	35	8435 003	87	8642 000	12		
7266 032	137	7605 032	129	8152 000	114	8439 043	88	8643 000	20		
7270 032	121	7606 032	132	8152 100	52	8439 112	88	8643 115	35		
7271 032	121	7607 032	132	8153 100	15	8439 901	88	8643 116	35		
7272 032	121	7610 032	135	8154 000	15	8441 000	103	8643 117	60		
7273 032	121	7615 032	135	8154 600	27	8441 030	103	8644 003	54		
7276 032	125	7621 032	133	8155 000	87	8442 500	105	8644 004	15		
7277 032	125	7622 032	133	8159 101	12	8443 002	105	8644 041	26		
7278 032	125	7623 032	133	8172 000	114	8448 500	104	8644 100	17		
7280 032	122	7624 032	133	8173 000	114	8449 500	105	8644 100	65		

Foster management system is ISO 9001:2008 certified
Registration number CH-36474



WARRANTIES

All Foster products conform to the EEC directive and are covered by the Foster 24-month warranty.

DEALERS

Our dealers are highly selected and are able to provide a professional service for our production range. For information please consult our web site **www.fosterspa.com** or contact us: **info@fosterspa.com**.

ASSISTANCE

We wish to provide you with products and service that meet your expectations. This is why Foster has a widespread network of Technical Assistance centres in Italy and abroad.

WORLDWIDE AFTER-SALES SERVICE

For an up to date list of Foster's technical assistance centres, consult our web site **www.fosterspa.com**



SHOWROOM

Foster Technical Info Center Milano

Via San Marco, 12
20121 – MILANO – ITALY
Tel +39 02 89763549
e-mail: milano@fosterspa.com
www.fosterexperience.com

Each single item manufactured by Foster is branded CE, and is therefore made in compliance with the general regulations of the European Union. This publication is for international use. The features are purely guideline. We reserve the right to modify them at any moment without notice. The Foster organisation will be pleased to provide further details and updates about the products and services.

© Foster spa. Not to be reproduced wholly or in part without written permission of Foster spa.

Realized in collaboration with Maxistudio.

Printed in May 2017

