

MAKU

essential emotions



FAP
CERAMICHE
Naturalmente casa.

MAKU

essential emotions

MAKU

una piastrella in gres porcellanato che riproduce una pietra matt dai morbidi toni naturali, per rivestire con eleganza contemporanea pareti e pavimenti.

a porcelain stoneware tile that mimics matt stone in soft, natural colours, ready to bring a touch of contemporary elegance to floors and walls.

parfaite réplique d'une pierre matt aux tons naturels, ce grès cérame apportera aux sols comme aux murs une élégance contemporaine. / eine Feinsteinzeugfliese, die einen matten Stein mit weichen, natürlichen Farbtönen nachahmt, um Wände und Fußböden mit zeitgemäßer Eleganz zu verkleiden. / una baldosa en gres porcelánico que reproduce una piedra matt de suaves tonos naturales para revestir con elegante modernidad paredes y pavimentos. / естественные и нежные оттенки камня matt воплощены в настенной и напольной плитке из керамогранита, создающей элегантную и современную атмосферу.

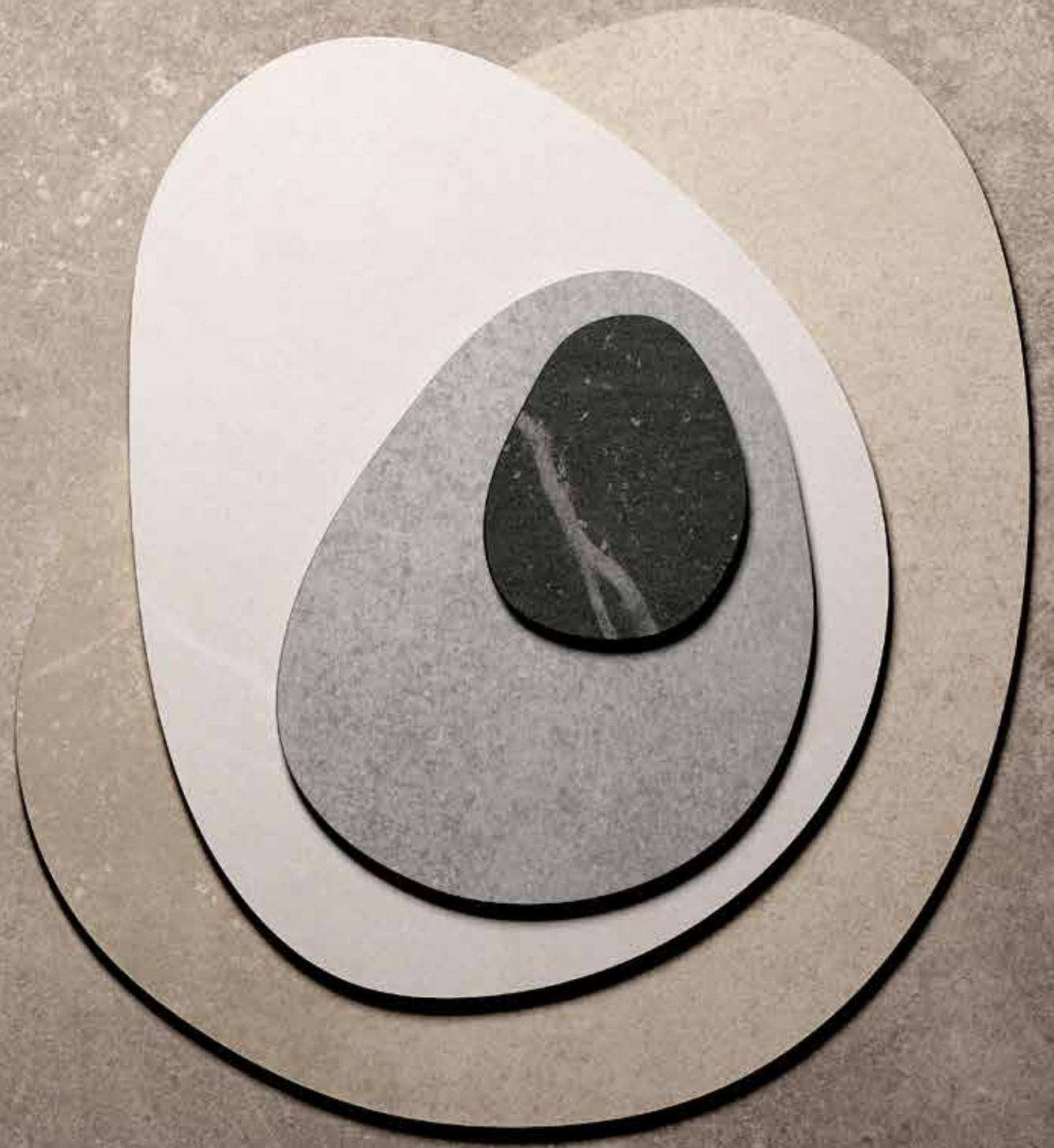

MATT



SATIN

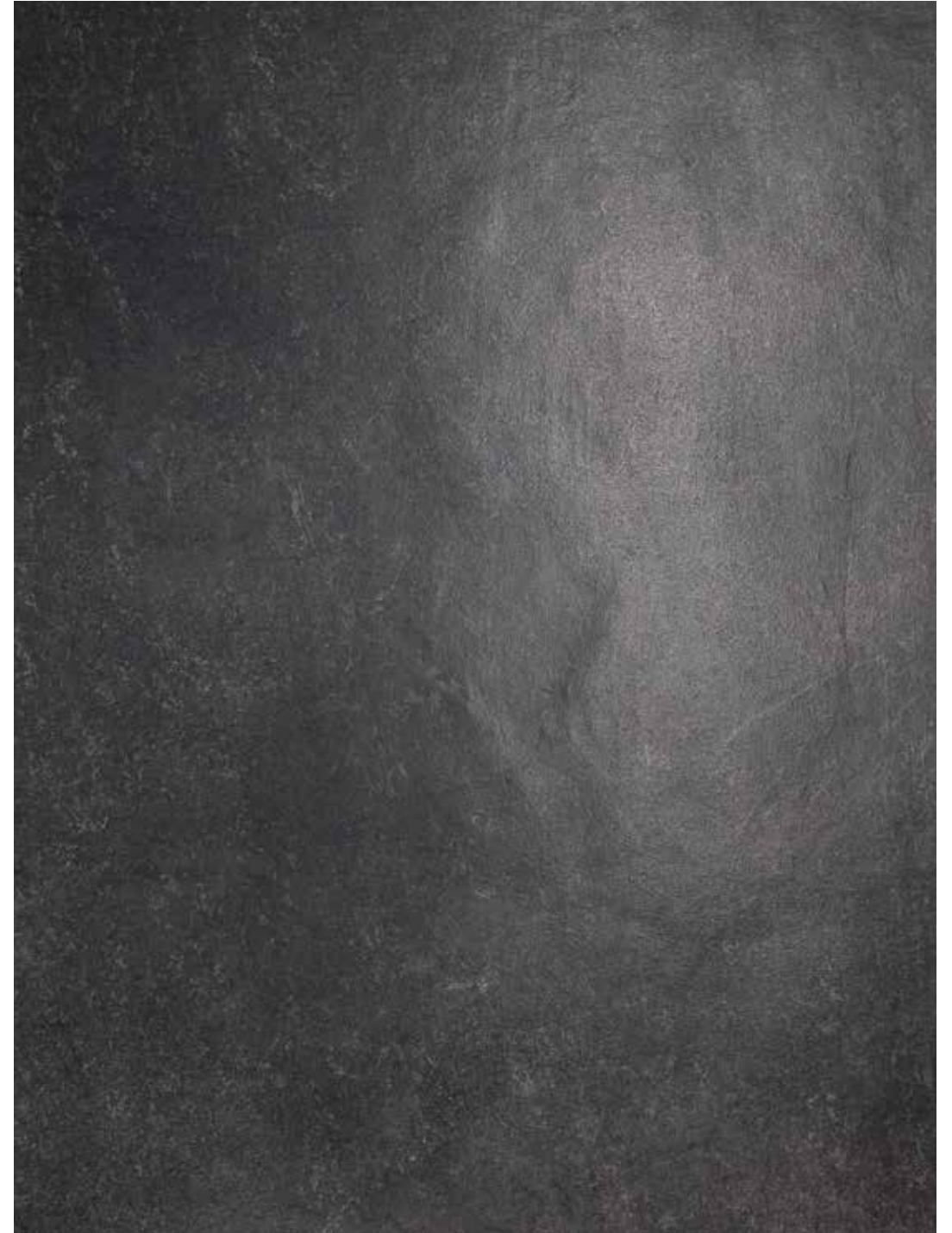



Wall
Maku Grey

Floor
Maku Grey Satin

HOMIE

affascinante e originale la declinazione di Maku Grey nel formato 20x20 che riveste il camino. raffinati e delicati i riflessi del pavimento in 75x75 cm, naturalmente imperfetto nella finitura Satin.

original, distinctive allure for Maku Grey in the 20x20 size for the fireplace. delicately sophisticated reflections on the 75x75 cm floor tiles, with natural imperfections and a Satin finish.

sublime et originale la version 20x20 de Maku Grey qui revêt la cheminée, naturellement imparfaite par ses reflets subtils et raffinés la surface du sol en 75x75 cm dans sa finition Satin. / faszinierend und originell diese Version von Maku Grey im Format 20x20, mit der der Kamin verkleidet wurde, raffiniert und zart die Reflexe des auf natürliche Art unvollendeten Fußbodens im Format 75x75 cm in der Oberflächenausführung Satin. / fascinante y original la declinación de Maku Grey en el formato 20x20 que reviste la chimenea, refinados y delicados los reflejos del pavimento en 75x75 cm, naturalmente imperfecto en el acabado Satin. / восхитительное и оригинальное решение облицовывающей камин плитки Maku Grey формата 20x20, утонченные и нежные блики напольной плитки формата 75x75 см и естественное несовершенство отделки Satin.

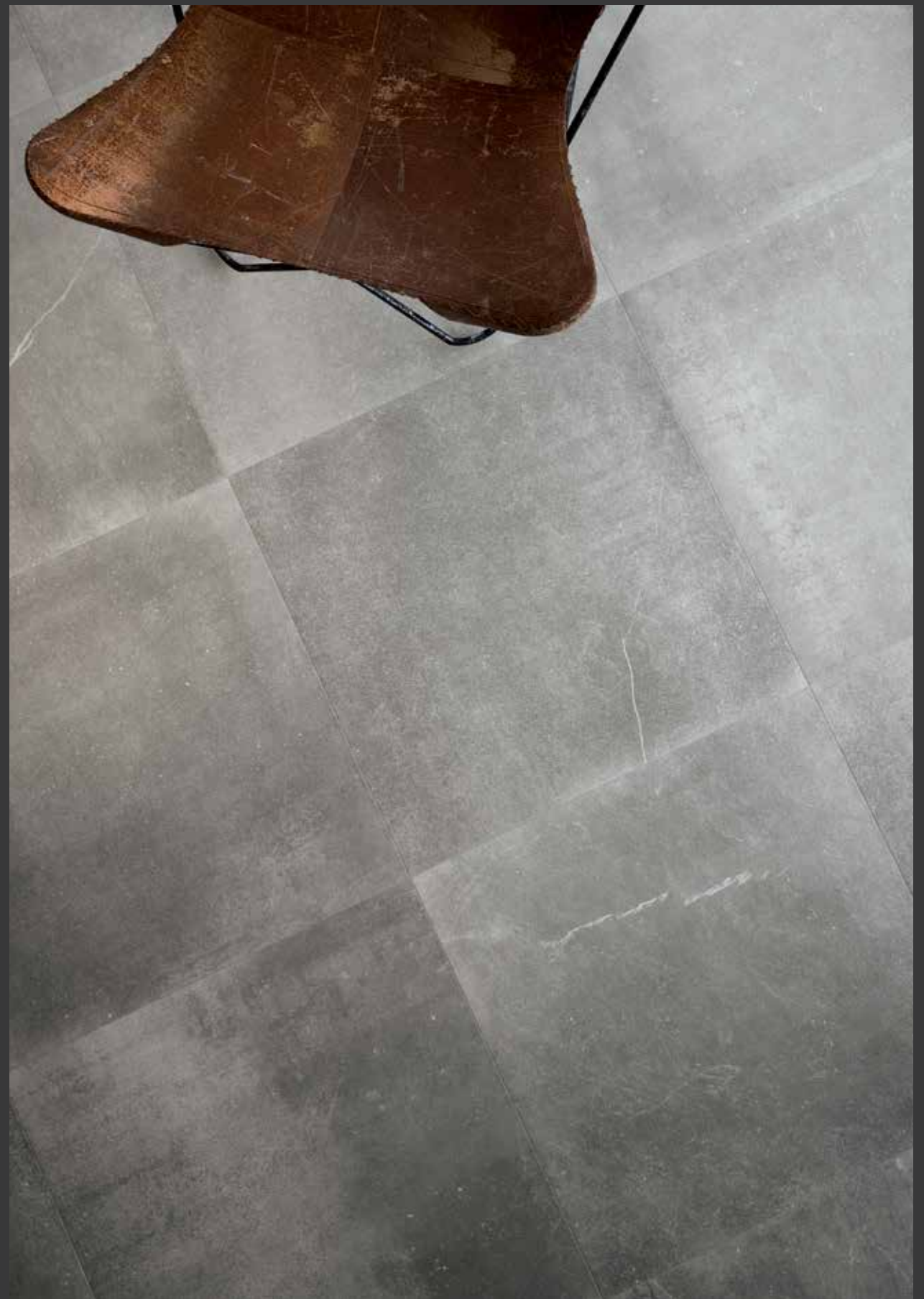



Wall
Maku Dark
Floor
Maku Dark Matt

sophisticated Dark





I LOVE MY KITCHEN





Ingredients 20x20 Déco Light + 7,5x30 Dark

in linea con le più attuali tendenze d'arredo, uno spazio contemporaneo ottenuto con una raffinata trama di decorazioni grafiche e un pavimento con una superficie naturale dal sapore artigianale.

in line with the very latest furnishing trends, a contemporary setting obtained thanks to sophisticated graphic patterns and a floor with a natural surface with a hand-crafted look.



Wall
Maku Deco Light
Floor
Maku Dark

épousant les tendances les plus actuelles en matière de décoration, cet espace se veut très contemporain par sa trame de décors graphiques et la surface naturelle presque artisanale de son sol. / im Einklang mit den aktuellsten Einrichtungstendenzen ein zeitgenössischer Raum, der mit einem raffinierten Muster aus grafischen Dekorationen und einem Fußboden mit einer natürlichen, scheinbar von Hand gefertigten Oberfläche gestaltet wurde. / en línea con las tendencias más actuales en decoración, un espacio contemporáneo obtenido a partir de una refinada trama de decoraciones gráficas y de un pavimento cuya superficie natural tiene sabor artesanal. / оформленное согласно последним тенденциям в мире дизайна интерьеров это современное пространство — результат сочетания изысканных графических мотивов с напольным покрытием в стиле ремесленной керамики.

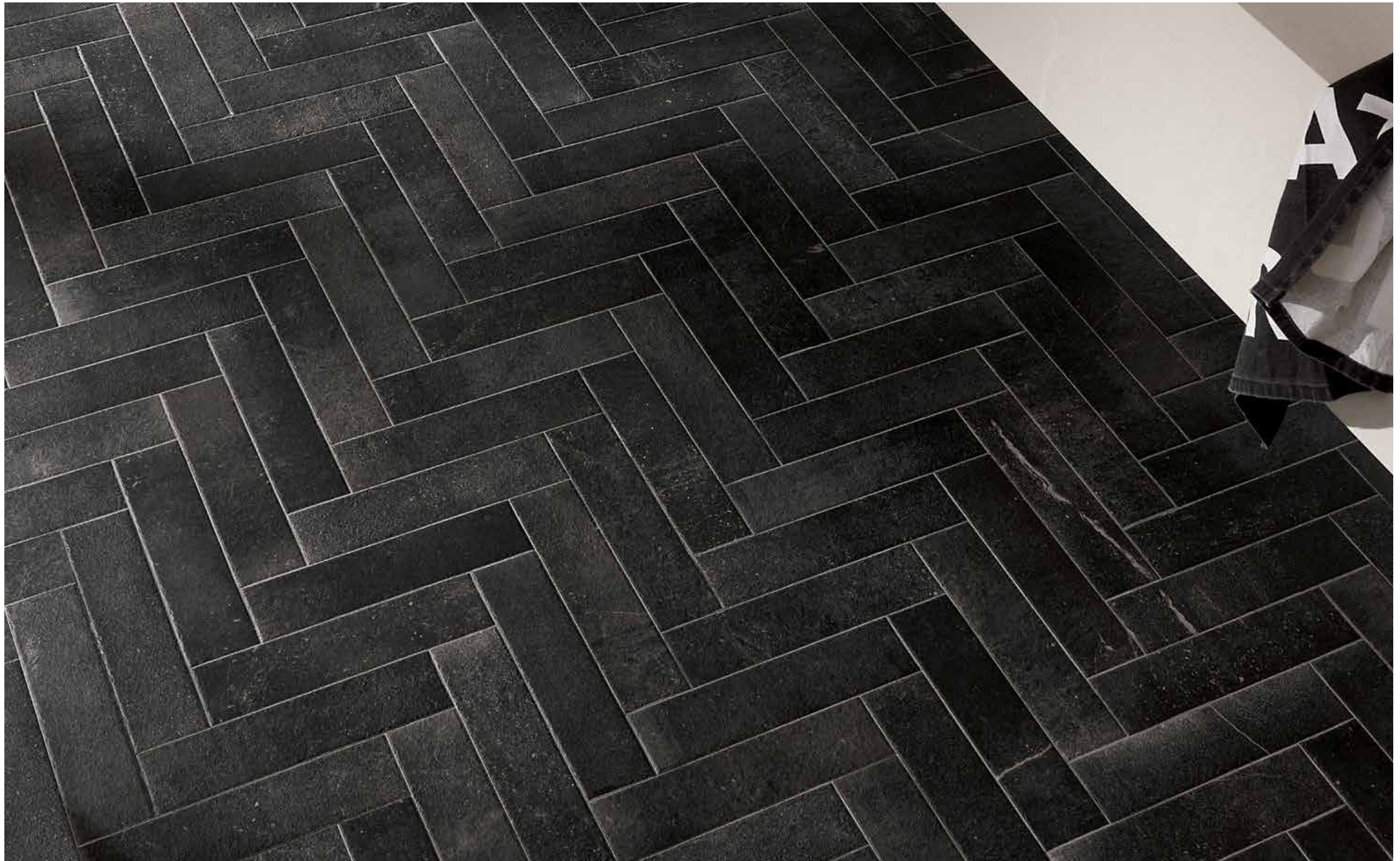

CONTEMPORARY NATURAL



Wall
Maku Dark
Maku Déco Dark
Floor
Maku Dark



20x20 Déco Dark



Wall
Maku Nut
Maku Nut Spigolo
Floor
Maku Nut Matt



spigolo e angolo permettono di rivestire il piano lavoro con una precisione impeccabile.

edges and corners allow us to tile working tops with flawless precision.

baguettes et angles en céramique permettent une finition parfaite du plan de travail. / Kantenriemchen und Außenecken erlauben uns, Arbeitsflächen mit einwandfreier Genauigkeit auszuarbeiten. / cantoneras y esquinas permiten de revestir superficies de trabajo con precisión impecable. / кромка и уголок позволяют выполнить укладку с абсолютной точностью.



simply
Nut



GRID WHITE
WELCOME
BREAKFAST!

Wall
Maku Light
Maku Grid White

Maku Trace & Déco Dark





spontanea,
organica,
tridimensionale:
la superficie
è design puro.

spontaneous,
organic,
three-dimensional:
a surface that
is pure design.

spontanée,
organique,
tridimensionnelle :
la surface
est design à l'état pur.

spontan,
organisch,
dreidimensional:
die Oberfläche
ist pures Design.

espontánea,
orgánica,
tridimensional; l
a superficie
es puro diseño.

неожиданная,
органичная,
трехмерная:
поверхность
стильного дизайна



Wall
Maku Grey
Maku Rock Grey
Wall Silver Listello
Floor
Maku Grey Matt

Maku Grey





Wall
 Maku Nut
 Maku Rock Nut
 Maku Random Mosaico Nut

Floor
 Maku Nut Satin



Maku Nut

un bagno color tortora,
 caratterizzato dalla superficie Rock
 e dal mosaico Random.

a dove-grey coloured bathroom,
 with a Rock surface
 and Random mosaic.



une salle de bains couleur gris taupe, que la texture Rock et la mosaïque Random complètent avec finesse. / ein Badezimmer in der Farbe graubeige, dessen Merkmale die Rock-Oberfläche und das Random-Mosaik sind. / un baño color tórtola, caracterizado por la superficie Rock y el mosaico Random. / ванная комната светло-бежевого цвета выложена плиткой Rock и мозаикой Random.



Wall
Maku Light
Fap Mosaici Ramage White



Mosaico Ramage

una tecnica innovativa e unica permette di realizzare un mosaico decorato a motivo continuo.

a unique, innovative technique used to create a mosaic with a continuous pattern.

une technique nouvelle et unique permet de réaliser un motif sans interruption sur la mosaïque. / eine innovative, einzigartige Technik, dank der man ein Deko-Mosaik mit durchgehenden Motiven fertigen kann. / una técnica innovadora y única permite realizar un mosaico decorado con motivo continuo. / инновационная и уникальная техника позволяет создать декорированную мозаику с непрерывным рисунком.

MOSAICO

PASTA BIANCA

BRICK + RANDOM + RAMAGE. tre formati differenti di mosaici disponibili in pasta bianca.

WHITE BODY

BRICK + RAMAGE + RANDOM. three different sizes for three different white-body mosaics.

BRICK + RAMAGE + RANDOM. trois types de mosaïques disponibles en pâte blanche. / BRICK + RAMAGE + RANDOM. drei verschiedene Mosaikformate, die weißscherbig erhältlich sind. / BRICK + RAMAGE + RANDOM. tres formatos diferentes de mosaicos disponibles en pasta blanca. / BRICK + RAMAGE + RANDOM. три различных формата мозаики из белой массы.

MACROMOSAICO + SPINA + MICRO-MOSAICO + MACROMOSAICO OUT. quatre version de mosaïques en grès cérame. / MACROMOSAICO + SPINA + MICROMOSAICO + MACROMOSAICO OUT. Vier verschiedene Mosaikpersönlichkeiten aus Feinsteinzeug. / MACROMOSAICO + SPINA + MICRO-MOSAICO + MACROMOSAICO OUT. cuatro estilos distintos de mosaicos en gres porcelánico. / MACROMOSAICO + SPINA + MICROMOSAICO + MACROMOSAICO OUT. четыре различных характера мозаики из керамогранита.

MOSAICO

GRES PORCELLANATO

MACROMOSAICO + SPINA + MICROMOSAICO + MACROMOSAICO OUT. quattro diverse personalità di mosaici in gres porcellanato.

PORCELAIN STONEWARE

MACROMOSAICO + SPINA + MICROMOSAICO + MACROMOSAICO OUT. four different mosaic personalities in porcelain stoneware.

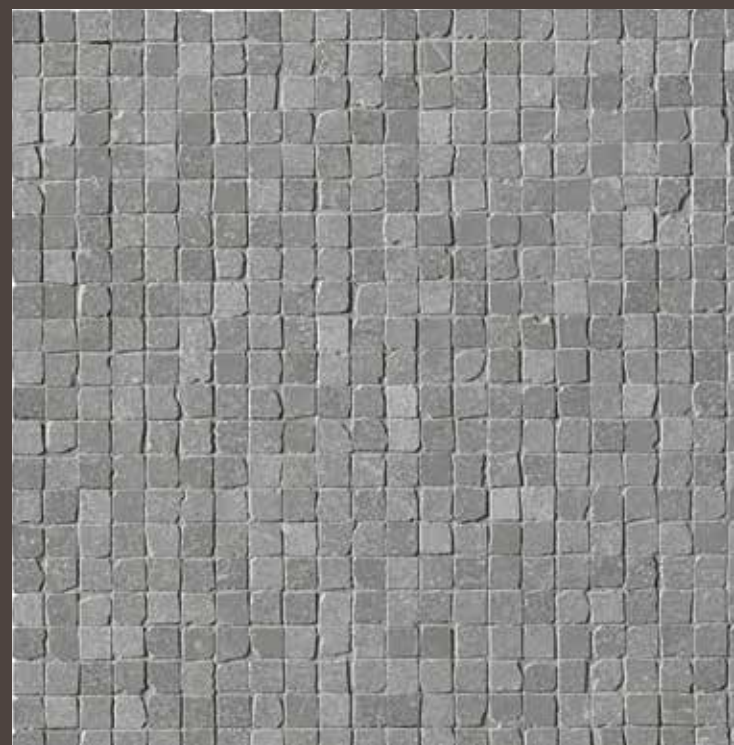

MAKU MOSAIC

è l'anima artigianale italiana a rendere unici questi meravigliosi mosaici. le ricercate imperfezioni della materia trovano, attraverso la stuccatura, la loro sofisticata bellezza.

marvellous mosaics with unique Italian craftsmanship at their heart. the sophisticated imperfections of the material shape refined beauty through the grouting process.

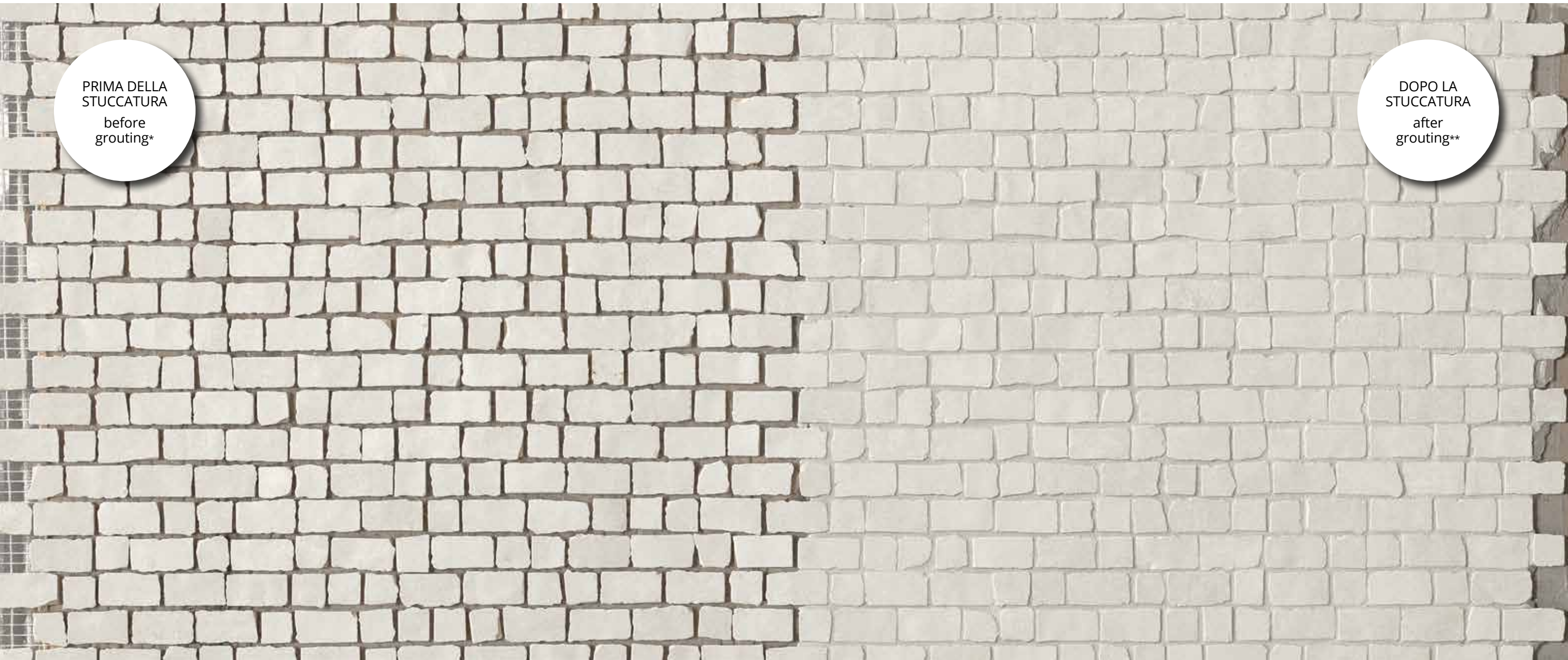

PRIMA DELLA
STUCCATURA
before
grouting*

DOPO LA
STUCCATURA
after
grouting**

C'est le savoir faire des artisans italiens qui grâce à l'esprit artisanal italien si ces merveilleuses mosaïques sont uniques. le charme d'une matière aux imperfections recherchées, dont la beauté sophistiquée est rehaussée par les jointoiements. / die Einzigartigkeit dieser wunderschönen Mosaik ist der handwerklichen Fertigkeit Italiens zu verdanken. die edlen Unregelmäßigkeiten des Materials erhalten durch das Verfugen eine raffinierte Schönheit. / es el alma artesanal italiana y aporta exclusividad a estos maravillosos mosaicos. las esmeradas imperfecciones de la materia encuentran con el estucado su sofisticada belleza. / Душа традиционной итальянской керамики превращает эту великолепную мозаику в уникальное произведение искусства. Неуловимое несовершенство плитки в сочетании с затиркой создают атмосферу красоты и изящества.

* avant jointoiement, vor dem Verfugen, antes del estucado, до затирки.

** après jointoiement, nach dem Verfugen, después del estucado, до после затирки.

MAKU

Maku, una superficie pregiata per creare un giusto equilibrio tra rigore architettonico e calore essenziale.

Maku, a fine-quality surface to strike a perfect balance between architectural rigour and essential warmth.

Maku, une surface raffinée, pour créer le juste équilibre entre rigueur architectonique et atmosphère chaleureuse.

Maku, eine edle Oberfläche, um das richtige Gleichgewicht zwischen der architektonischen Strenge und der Grundwärme herzustellen.

Maku, una superficie sublime para crear un justo equilibrio entre rigor arquitectónico y calor esencial.

Маку - это великолепная плитка, позволяющая достичь идеальное равновесие между архитектурной строгостью и желанным уютom.



Wall
Maku Nut Matt
Maku Nut Out

Floor
Maku Nut Satin





Il mattoncino in versione Maku Grey: un classico che riesce sempre a stupire con la sua contemporaneità.

Maku Grey brick tiles: a classic, amazingly contemporary solution.

La briquette version Maku Grey : un classique qui parvient toujours à surprendre par sa modernité. / Der Ziegel in der Version Maku Grey: ein Klassiker, der jederzeit mit seiner Zeitgemäßheit überrascht. / El ladrillo en versión Maku Grey; un clásico que siempre sorprende por su modernidad. / Кирпичная стена в версии Maku Grey: классическое решение, не перестающее восхищать своей современностью.

COFFEE PLEASE

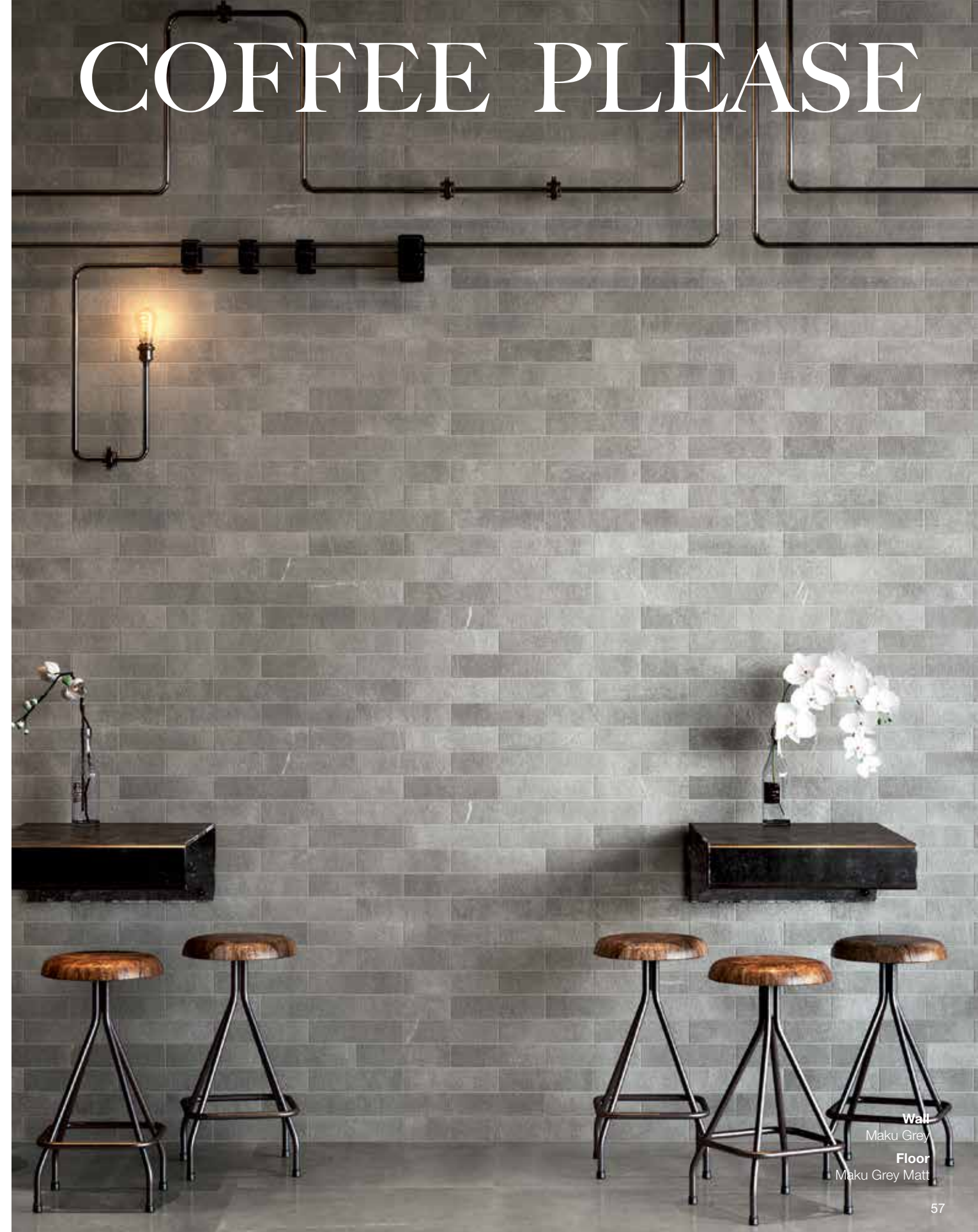

Wall
Maku Grey
Floor
Maku Grey Matt



SHOP
style is
everywhere

Wall
Maku Light
Floor
Maku Light Satin



Ogni volume dello spazio diventa una affascinante scenografia naturale con la praticità e la resistenza del gres porcellanato.

Every volume becomes a delightful natural setting, thanks to the practical, hard wearing appeal of porcelain stoneware.



Chacun des volumes de cet espace apparait comme un fascinant décor naturel que les vertus et la résistance du grès cérame rendront facile à entretenir. / Jeder Raum wird zu einer faszinierenden natürlichen Kulisse mit der Zweckmäßigkeit und Widerstandsfähigkeit von Feinsteinzeug. / Cada volumen del espacio se convierte en una magnífica escenografía natural con la eficiencia y la resistencia del gres porcelánico. / Любой формирующий пространство проем превращается в естественную декорацию, сочетающую в себе практичность и надежность керамогранита.



MILANO





WALL



FLOOR





SPA

surface is
the new wellness

caldo e roccioso l'effetto della parete frontale rivestita con il Dark versione out. sofisticato e sicuro il pavimento in macromosaico out perché antiscivolo certificato R 11.

front wall with a warm, rocky effect, tiled with the outdoor version of Maku Dark. sophisticated, safe flooring in macromosaico out, with anti-slip certification R 11.



effet chaleureux et brut, pour le mur du fond revêtu avec Maku Dark version out. Raffinement et sécurité, c'est ce qu'offre le sol en macromosaico out qui bénéficie d'un classement antidérapant « R 11 »

warm und felsig ist die Wirkung der Frontwand, die mit Maku Dark in der Version out verkleidet wurde. die Innovation dieses Fußbodens in macromosaico out ist auch der Rutsicherheit Klasse R 11 zu verdanken.

cálido y rocoso el efecto de la pared frontal revestida con Maku Dark versión out. sofisticado y seguro el pavimento en macromosaico out por ser antideslizante certificado R 11.

caldo e roccioso l'effetto della parete frontale rivestita con Maku Dark versione out. sofisticato e sicuro il pavimento in macromosaico out perché antiscivolo certificato R11.



Wall
Maku Dark Matt
Maku Dark Out

Floor
Maku Macromosaico Dark Out

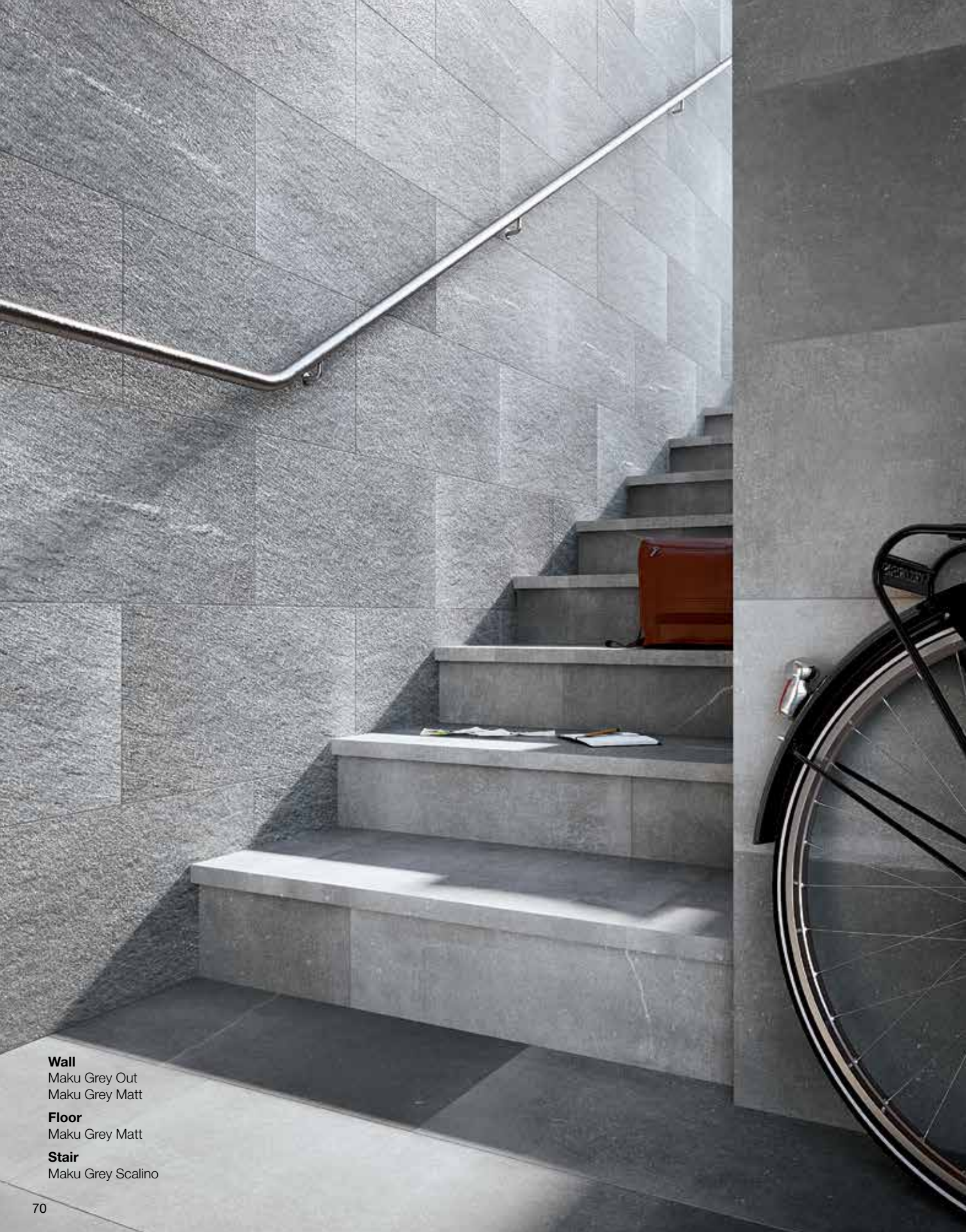

Wall
Maku Grey Out
Maku Grey Matt

Floor
Maku Grey Matt

Stair
Maku Grey Scalino

OUTDOOR

Maku è la materia ideale per rivestire spazi esterni grazie alla resistenza al gelo e all'usura. la dotazione dei pezzi speciali garantisce perfetti rivestimenti per le scale.

Maku is the ideal covering material for outdoors, able to stand up to frost and wear. perfect as a covering material for stairs thanks to the special trims.



Maku est le matériau idéal pour les espaces extérieurs : il résiste au gel et à l'usure et dispose des pièces spéciales notamment pour revêtir les escaliers. / Maku ist dank der Frostbeständigkeit und der Verschleißfestigkeit das ideale Material, um die Außenbereiche zu verkleiden. dank der Formteileausstattung ist die perfekte Verkleidung der Treppen garantiert. / Maku es la materia perfecta para revestir espacios de exterior al ser resistente a la helada y al desgaste. los elementos especiales a disposición garantizan perfectos revestimientos para las escaleras. / Благодаря таким качествам, как морозостойкость и износоустойчивость, плитка Maku отлично подходит для оформления уличных покрытий. дополнительные специальные элементы обеспечивают идеальную укладку лестницы.



MAKU PLANS



Wall A
 Maku Light 25x75
 Maku White Ramage 30,5x30,5
 Maku Light Spigolo 1x25
 Maku Light Spigolo A.E. 1x1

Wall B - C - D
 Maku Light 25x75
Floor
 Maku Light 60x60 RT

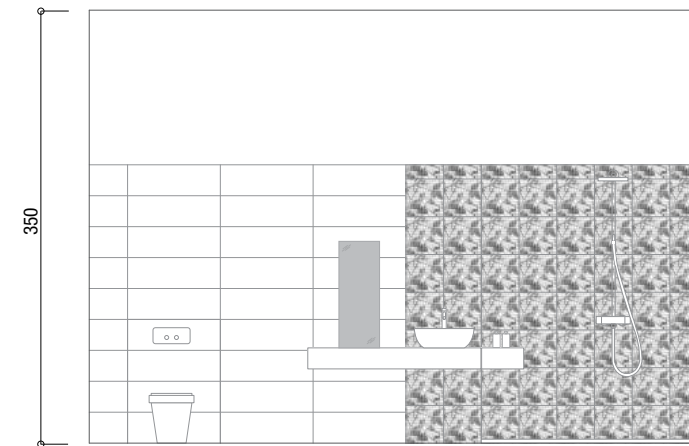
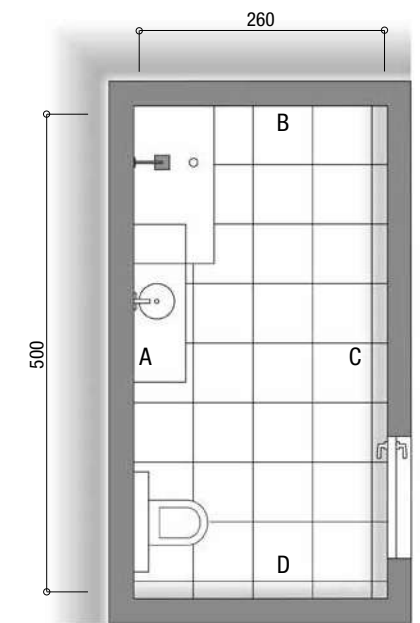

Wall A

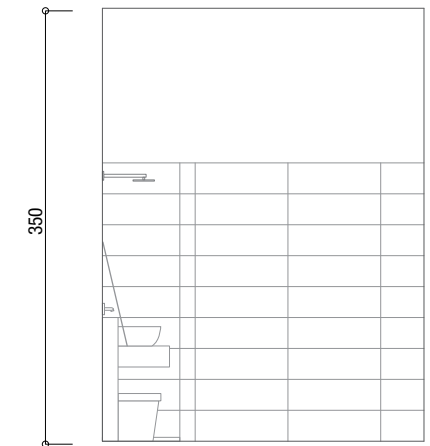

Wall B

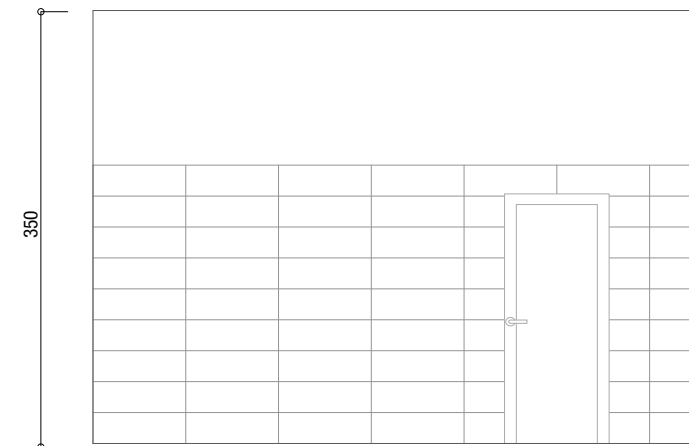

Wall C

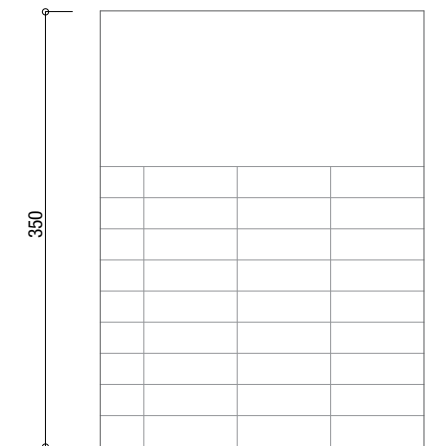

Wall D

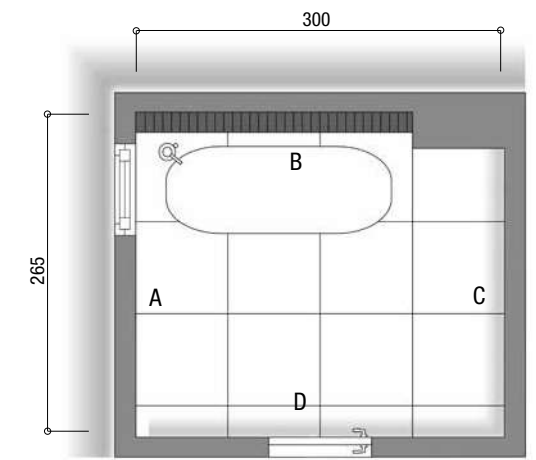
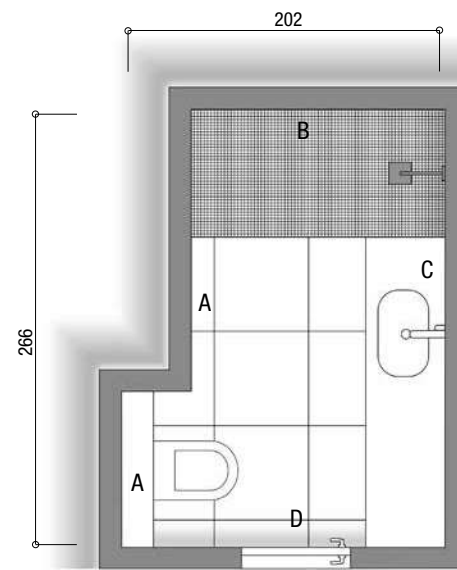

Wall A
 Maku Grey 25x75
 Maku Rock Grey 25x75
 Lumina Silver Listello Satinato 1,5x75
Wall C
 Maku Rock Grey 25x75

Wall B - D
 Maku Grey 25x75
 Lumina Silver Listello Satinato 1,5x75
Floor
 Maku Grey 60x60 RT

Wall A - C - D
 Maku Nut 25x75
Floor
 Maku Nut Satin 75x75 RT

Wall B
 Maku Nut 25x75
 Maku Rock Nut 25x75
 Maku Nut Mosaico Random 30,5x30,5
 Maku Nut Spigolo 1x25

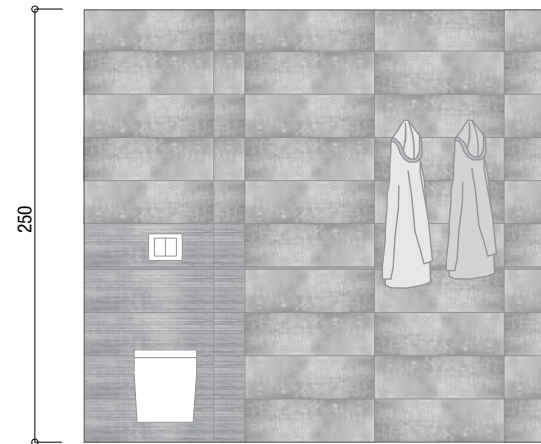

Wall A

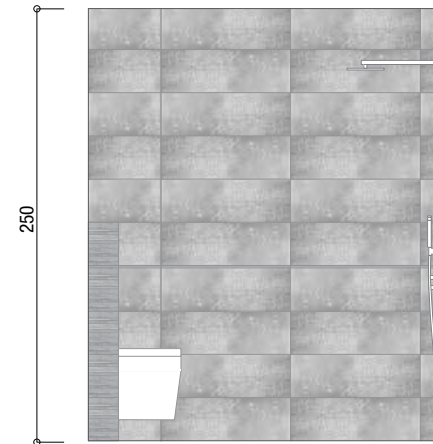

Wall B

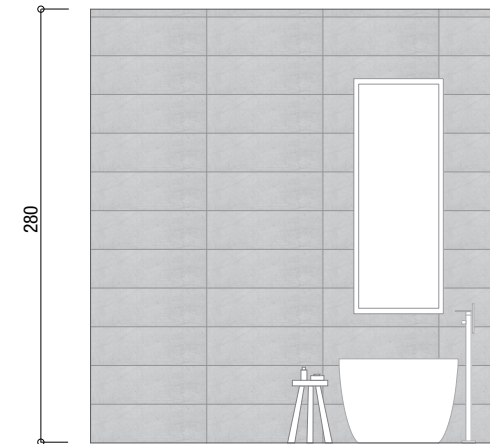

Wall A



Wall B

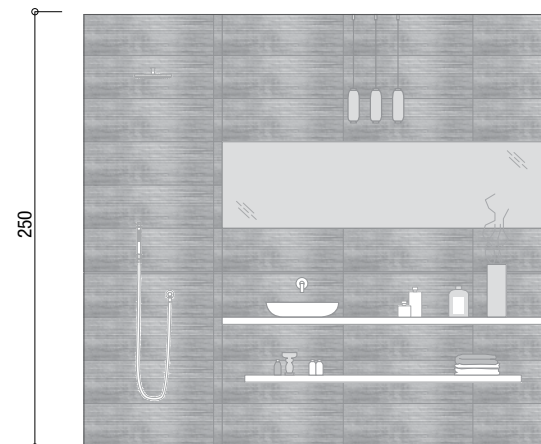

Wall C

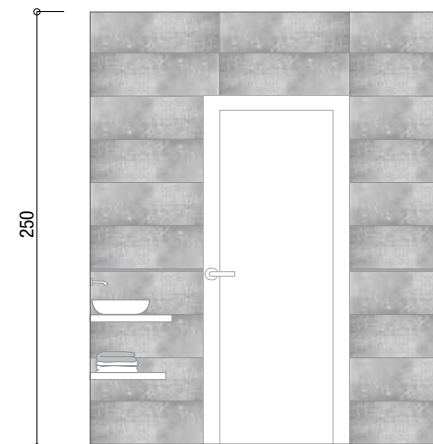

Wall D

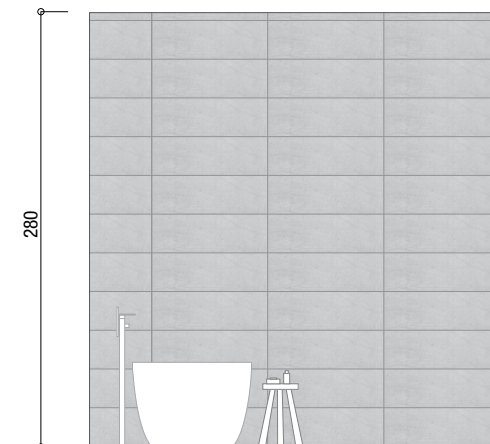

Wall C

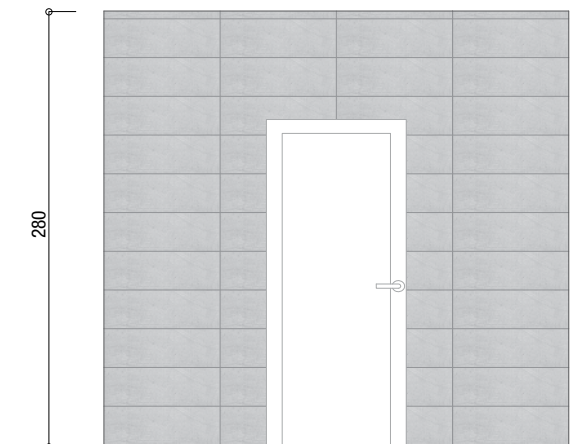

Wall D



Maku Grey 25x75 V2 1 Maku Light 25x75 V2 1 Maku Nut 25x75 V2 1

Maku Grey Spigolo 1x25 2 Maku Light Spigolo 1x25 2 Maku Nut Spigolo 1x25 2

A.E. Spigolo 1x1 3 A.E. Spigolo 1x1 3 A.E. Spigolo 1x1 3



Maku Rock Grey 25x75 V2 4 Maku Rock Light 25x75 V2 4 Maku Rock Nut 25x75 V2 4

Lumina Satinato Silver Listello 1,5x75 2

MOSAICO

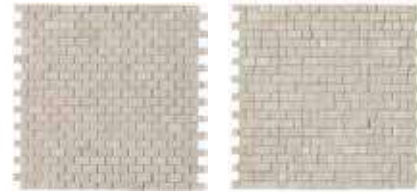

Maku Grey Brick Mosaico 30,5x30,5 6 Maku Grey Random Mosaico* 30,5x30,5 6



Maku Light Brick Mosaico 30,5x30,5 6 Maku Light Random Mosaico* 30,5x30,5 6

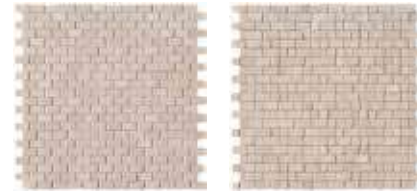

Maku Nut Brick Mosaico 30,5x30,5 6 Maku Nut Random Mosaico* 30,5x30,5 6

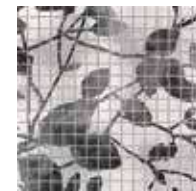

Fap Mosaici Ramage White Mosaico** 30,5x30,5 6

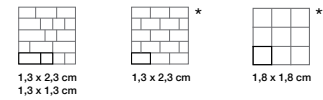

	Unità di vendita Sales unit	MQ./Box	PZ./Box	Kg/Box	Box/PL
1	1 Box	1,125	6	16,80	54
2	1 Box	-	5	-	-
3	1 Box	-	4	-	-
4	1 Box	0,937	5	14,25	54
5	1 Box	0,558	6	8,20	84



Maku Dark 7,5x30 V2



Maku Grey 7,5x30 V2



Maku Nut 7,5x30 V2



Maku Sand 7,5x30 V2



Maku Light 7,5x30 V2

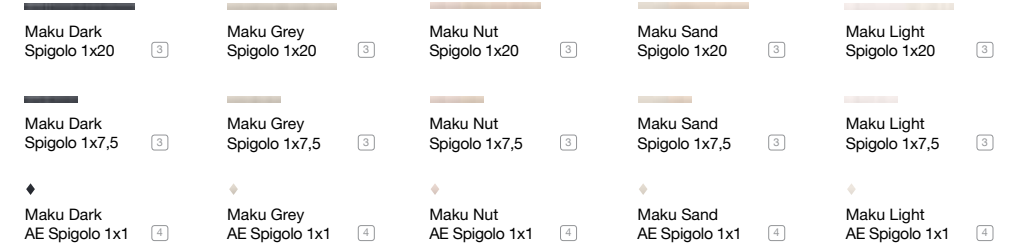

MATT _____ **R10**

7,5x30 ①



Maku Dark 20x20 V2



Maku Grey 20x20 V2



Maku Nut 20x20 V2



Maku Sand 20x20 V2



Maku Light 20x20 V2

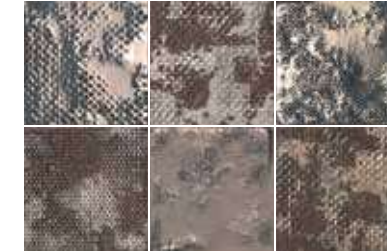

Maku Grid Metal Inserto Mix 6 40x60 ⑤



Maku Grid White Inserto Mix 6 40x60 ⑤

MATT _____ **R10**

20x20 ②



Maku Déco Dark 20x20 V2

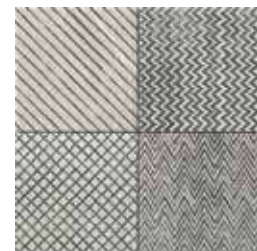

Maku Déco Light 20x20 V2



Maku Trace Dark Inserto Mix 6 40x60 ⑤



Maku Trace Sand Inserto Mix 6 40x60 ⑤

MATT _____ **R10**

20x20 ②

Maku 7,5x30: Fuga 2-5 mm / 2-5 mm gap / Joint 2-5 mm / Junta 2-5 mm / швом 2-5 мм

Maku 20x20: Fuga 2-3 mm / 2-3 mm gap / Joint 2-3 mm / Junta 2-3 mm / швом 2-3 мм

	Unità di vendita Sales unit	MQ./Box	PZ./Box	Kg/Box	Box/PL
①	1 Box	1,080	48	19,50	48
②	1 Box	1,20	30	23,90	56
③	1 Box	-	5	-	-
④	1 Box	-	4	-	-
⑤	1 Box	-	1 MIX	4,80	-



Maku Dark V2

MATT _____ **R 9**



SATIN _____



OUT _____ **R11C(A+B+C)**



Maku Grey V2

MATT _____ **R 9**



SATIN _____



OUT _____ **R11C(A+B+C)**



Maku Nut V2

MATT _____ **R 9**



SATIN _____



OUT _____ **R11C(A+B+C)**



Maku Sand V2

MATT _____ **R 9**



SATIN _____



OUT _____ **R11C(A+B+C)**

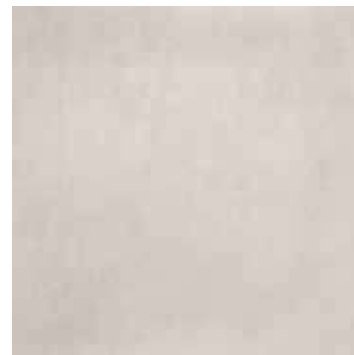

Maku Light V2

MATT _____ **R 9**



SATIN _____



OUT _____ **R11C(A+B+C)**



	Unità di vendita Sales unit	MQ./Box	PZ./Box	Kg/Box	Box/PL
1	1 Box	1,125	2	25,95	42
2	1 Box	1,080	3	24,82	40
3	1 Box	1,080	6	23,10	40

MOSAICO

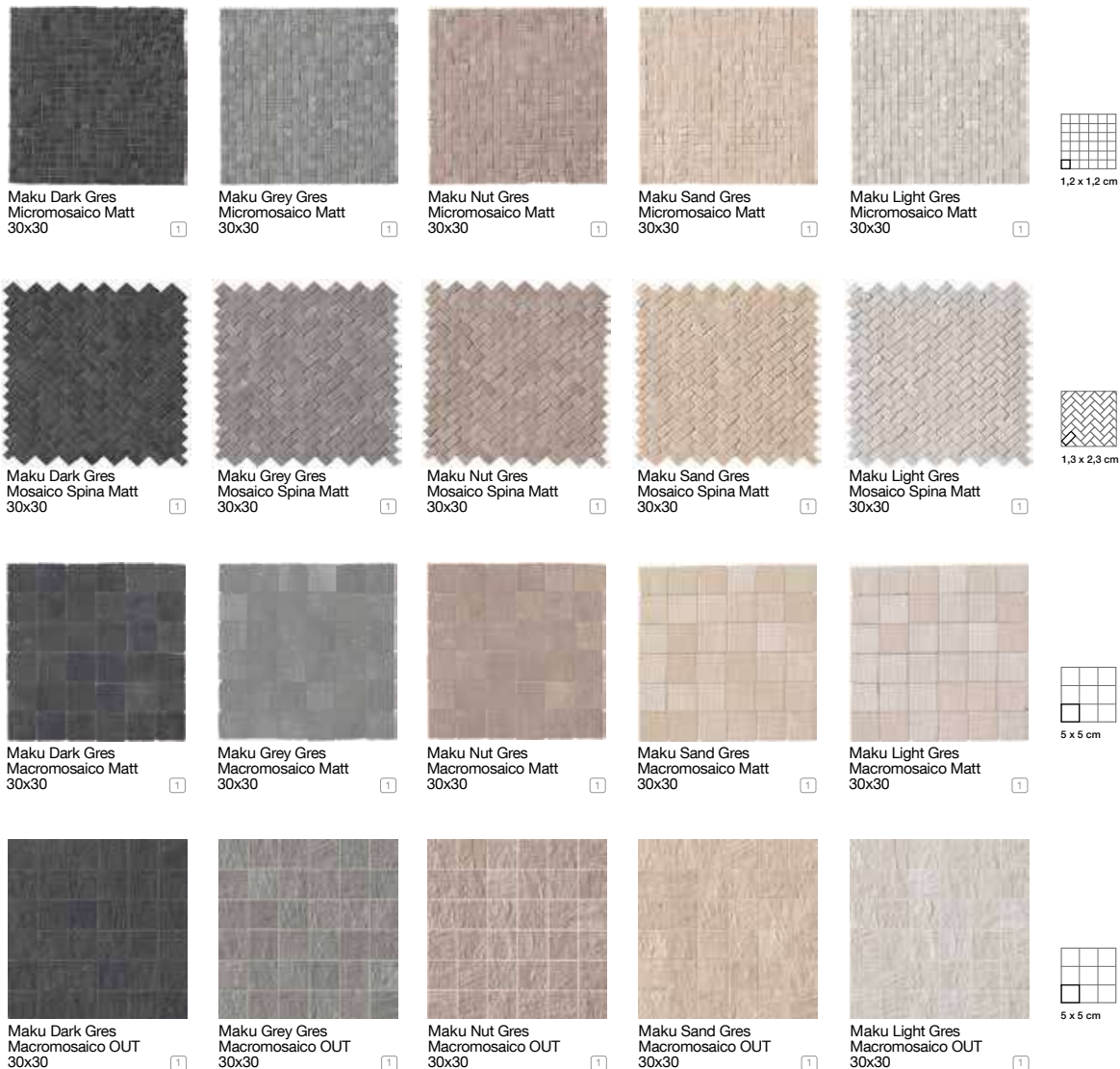

Pezzi Speciali IN

Disponibili in tutti i colori. - Available in all colours. - Existent dans tous les coloris. - Erhältlich in allen Farben. - Disponibles en todos los colores. - В продаже есть все цвета.

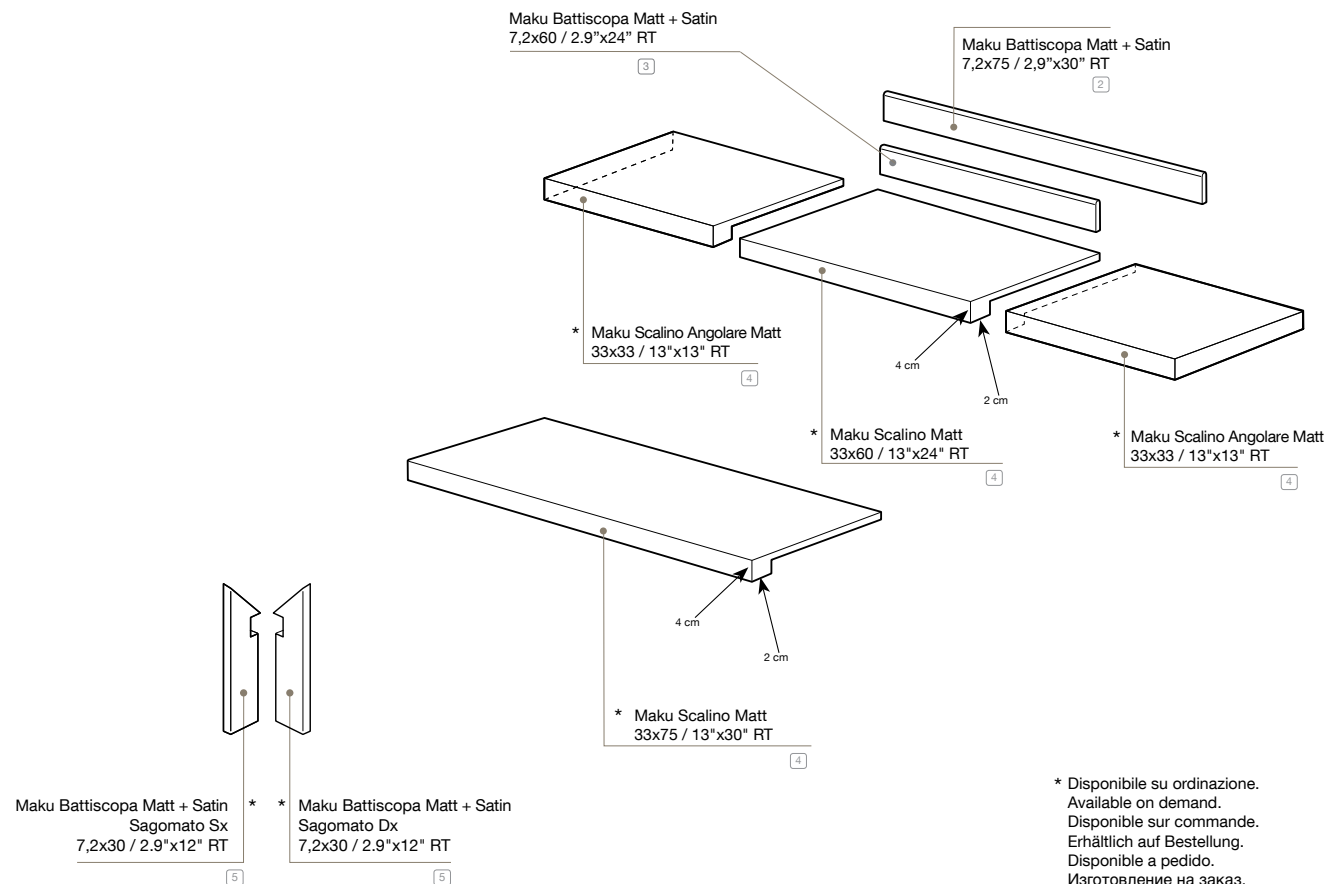





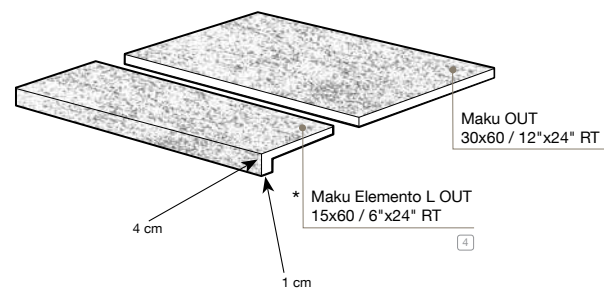









































































Pezzi Speciali OUT























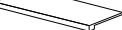





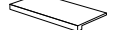





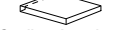

Disponibili in tutti i colori. - Available in all colours. - Existent dans tous les coloris. - Erhältlich in allen Farben. - Disponibles en todos los colores. - В продаже есть все цвета.



* Disponibile su ordinazione. Available on demand. Disponible sur commande. Erhältlich auf Bestellung. Disponible a pedido. Изготовление на заказ.

	Unità di vendita Sales unit	MQ./Box	PZ./Box	Kg/Box	Box/PL
1	1 Box	0,540	6	10,20	60
2	1 Box	3,75 ML	5	6,02	-
3	1 Box	4,80 ML	8	6,70	-
4	1 Box	-	2	-	-
5	1 Box	2,40 ML	8	3,55	-

MAKU		DARK	GREY	NUT	SAND	LIGHT
PASTA BIANCA WHITE BODY	 25x75 10"x30"	-	 MATT	 MATT	-	 MATT
	 Rock 25x75 10"x30"	-	 MATT	 MATT	-	 MATT
MOSAICI PASTA BIANCA WHITE BODY MOSAICS	 Brick Mosaico 30,5x30,5 12"x12"	-	 MATT	 MATT	-	 MATT
	 Random Mosaico 30,5x30,5 12"x12"	-	 MATT	 MATT	-	 MATT
	 Ramage 30,5x30,5 12"x12"	-	-	-	-	 MATT
ATELIER	 20x20 8"x8"	 MATT R10	 MATT R10	 MATT R10	 MATT R10	 MATT R10
	 7,5x30 3"x12"	 MATT R10	 MATT R10	 MATT R10	 MATT R10	 MATT R10
GRES PORCELLANATO PORCELAIN STONEWARE	 75x75 RT 30"x30"	 MATT R9	 SATIN	 MATT R9	 SATIN	 MATT R9
	 60x60 RT 24"x24"	 MATT R9	 MATT R9	 MATT R9	 MATT R9	 MATT R9
	 30x60 RT 12"x24"	 MATT R9	 MATT R9	 MATT R9	 MATT R9	 MATT R9
	 30x60 RT 12"x24" OUT	 MATT R11 B(A+B)	 MATT R11 B(A+B)	 MATT R11 B(A+B)	 MATT R11 B(A+B)	 MATT R11 B(A+B)
MOSAICI GRES PORCELLANATO PORCELAIN STONEWARE MOSAICS	 Micromosaico 30x30 12"x12"	 MATT	 MATT	 MATT	 MATT	 MATT
	 Spina 30x30 12"x12"	 MATT	 MATT	 MATT	 MATT	 MATT
	 Macromosaico 30x30 12"x12"	 MATT	 MATT	 MATT	 MATT	 MATT
	 Macromosaico OUT 30x30 12"x12"	 MATT	 MATT	 MATT	 MATT	 MATT

MAKU		DARK	GREY	NUT	SAND	LIGHT
PEZZI SPECIALI GRES PORCELLANATO PORCELAIN STONEWARE TRIMS	 Battiscopa 7,2x75 RT 2.9"x30"	 MATT	 SATIN	 MATT	 SATIN	 MATT
	 Battiscopa 7,2x60 RT 2.9"x24"	 MATT	 MATT	 MATT	 MATT	 MATT
	 Scalino 33x75 RT 13"x36"	 MATT	 MATT	 MATT	 MATT	 MATT
	 Scalino 33x60 RT 13"x24"	 MATT	 MATT	 MATT	 MATT	 MATT
	 Scalino Angolare 33x33 RT 13"x13"	 MATT	 MATT	 MATT	 MATT	 MATT
	 elemento L OUT 33x60 RT 13"x24"	 MATT	 MATT	 MATT	 MATT	 MATT

Test

Pasta Bianca - Standard EN 14411 (ISO 13006) Annex L Group BIII, E_b > 10%

White body. / Weißscherbiger. / Pâte blanche. / Pasta blanca. / Белой глины.

CARATTERISTICHE TECNICHE TECHNICAL SPECIFICATIONS CARACTERISTIQUES TECHNIQUES TECHNISCHE EIGENSCHAFTEN CARACTERÍSTICAS TÉCNICAS ТЕХНИЧЕСКИЕ ХАРАКТЕРИСТИКИ		NORME STANDARDS NORMES NORMEN NORMAS НОРМЫ	VALORE PRESCRITTO VALUES REQUIRED VALEUR PRESCRIPTE NORMVORGABE VALOR PRESCRITO ЗАДАННОЕ ЗНАЧЕНИЕ EN 14411 - ISO 13006 BIII (GL)	VALORE MEDIO FAP • AVERAGE FAP RATING VALEUR MOYENNE FAP DURCHSCHNITTSWERT FAP VALOR MEDIO FAP СРЕДНЕЕ ЗНАЧЕНИЕ FAP BIII	
DIMENSIONI SIZES DIMENSIONS GRÖSSEN DIMENSIONES РАЗМЕРЫ		Lunghezza e larghezza Lenght and width / Dimensions des côtés / Seitenlänge / Largo y ancho / Длина и ширина	± 0,5%, max 2 mm	Conforme In accordance	
		Spessore Thickness / Epaisseur / Stärke / Espesor / Толщина	± 10%, max 0,5 mm	Conforme In accordance	
		Ortogonalità Wedging / Orthogonalité / Rechtwinkligkeit / Ortogonalidad / Ортогональность	± 0,5%, max 2 mm	Conforme In accordance	
		Rettilineità degli spigoli Straightness of the edges / Equerrage des angles / Kantengeradheit / Rectilinearidad de las aristas / Прямолинейность углов	± 0,3%, max 1,5 mm	Conforme In accordance	
		Planarità Flatness / Planéité / Oberflächenqualität / Planicidad / Плоскостность	+ 0,5% (max 2,0 mm) - 0,3% (max -1,5 mm)	Conforme In accordance	
		Aspetto della superficie % senza difetti nel lotto di prova Quality of the surface Faultless % within the sample lot / Qualité de la surface % sans défauts dans le lot d'essai / Oberflächenqualität % an fehlerfreien Fliesen im Prüfbett / Aspecto de la superficie % sin defectos en el lote de prueba / Вид поверхности % без брака в пробной партии	≥ 95%	Conforme In accordance	
STRUTTURA STRUCTURE STRUCTURE STRUKTUR ESTRUCTURA СТРУКТУРА		Assorbimento d'acqua - valore medio % Water absorption - average value % / Absorption d'eau - valeur moyenne % / Wasseraufnahme - Durchschnittswert % / Absorción de agua - valor medio % / Водопоглощение Среднее значение %	ISO 10545-3 > 10%	Conforme In accordance	
			Sforzo di rottura Breaking strenght / Force de rupture / Bruchlast / Esfuerzo di ruptura / Усилие на излом	ISO 10545-4 S ≥ 600 N	Conforme In accordance
			Resistenza alla flessione Bending strength / Résistance à la flexion / Biegefestigkeit / Resistencia a la flexión / Прочность при изгибе	R ≥ 12	Conforme In accordance
SBALZI TERMICI THERMAL SHOCK ECARTS DE TEMPÉRATURE TEMPERATURWECHSEL CHOQUES TÉRMICOS ТЕМПЕРАТУРНЫЕ ПЕРЕПАДЫ		Resistenza agli sbalzi termici Thermal shock resistance / Resistance aux variations thermiques / Temperaturwechselfähigkeit / Resistencia a las diferencias de temperatura / Сопротивление температурным перепадам	ISO 10545-9	Conforme In accordance	
		Resistenza al cavillo Crazing resistance / Résistance aux craquelures / Haarriß-Beständigkeit / Resistencia al cuarteado / Сопротивляемость образованию кракелюров	ISO 10545-11	Conforme In accordance	
SUPERFICIE SURFACE SUPERFÄCHE SUPERFICIE ПОВЕРХНОСТЬ		Resistenza ai prodotti chimici di uso domestico e agli additivi per piscina Resistance to household chemicals and swimming pool salts / Résistance aux produits chimiques à usage domestique et aux adjuvants pour piscines / Beständigkeit gegen Haushaltchemikalien und Badewasserzusätze / Resistencia a los productos químicos de uso domestico o productos para la piscina / Сопротивляемость химическим средствам домашнего применения и добавкам для бассейна.	ISO 10545-13 GB Min.	Conforme In accordance	
		Resistenza a basse concentrazioni di acidi ed alcali Resistance to low concentrations of acids and alkalis / Résistance aux acides et aux alcalis à basse concentration / Beständigkeit gegen niedrigkonzentrierte Säuren und Laugen / Resistencia a concentración baja de acidos y álcali / Сопротивляемость кислотам и щелочам низкой концентрации	GLB Min.		
		Resistenza alle macchie Stain resistance / Résistance aux taches / Baständigkeit gegen Fleckenbildung / Resistencia a las manchas / Стойкость к загрязнению	ISO 10545-14 MINIMUM CLASS 3	5	

- Valore medio dei test condotti negli ultimi 24 mesi. Average rating of tests conducted during the last 24 months. Durchschnittswert der in den letzten 24 Monaten durchgeführten Tests. Valeur moyenne des essais menés au cours des 24 derniers mois. Valor medio de las pruebas llevadas a cabo en los últimos 24 meses. Среднее значение испытаний, проведенных в течение последних 24 месяцев.

Test

Gres Porcellanato - Standard EN 14411 (ISO 13006) Annex G Group BIa, E_b ≤ 0,5%

Porcelain. / Grès cerame. / Feinsteinzeug. / Gres porcelánico. / Керамогранит.

CARATTERISTICHE TECNICHE TECHNICAL SPECIFICATIONS CARACTERISTIQUES TECHNIQUES TECHNISCHE EIGENSCHAFTEN CARACTERÍSTICAS TÉCNICAS ТЕХНИЧЕСКИЕ ХАРАКТЕРИСТИКИ		NORME STAN- DARDS NORMES NORMEN NORMAS НОРМЫ	VALORE PRESCRITTO VALUES REQUIRED VALEUR PRESCRIPTE NORMVORGABE VALOR PRESCRITO ЗАДАННОЕ ЗНАЧЕНИЕ EN 14411 - ISO 13006 BIa (UGL e GL)	FAP - VALORE MEDIO • AVERAGE RATING VALEUR MOYENNE DURCHSCHNITTSWERT VALOR MEDIO СРЕДНЕЕ ЗНАЧЕНИЕ BIa UGL				
				MATT	SATIN	OUT		
DIMENSIONI SIZES DIMENSIONS GRÖSSEN DIMENSIONES РАЗМЕРЫ		Lunghezza e larghezza Lenght and width / Dimensions des côtés / Seitenlänge / Largo y ancho / Длина и ширина	± 0,6%, max 2 mm	Conforme In accordance	Conforme In accordance	Conforme In accordance		
		Spessore Thickness / Epaisseur / Stärke / Espesor / Толщина	± 5%, max 0,5 mm	Conforme In accordance	Conforme In accordance	Conforme In accordance		
		Ortogonalità Wedging / Orthogonalité / Rechtwinkligkeit / Ortogonalidad / Ортогональность	± 0,5%, max 2 mm	Conforme In accordance	Conforme In accordance	Conforme In accordance		
		Rettilineità degli spigoli Straightness of the edges / Equerrage des angles / Kantengeradheit / Rectilinearidad de las aristas / Прямолинейность углов	± 0,5%, max 1,5 mm	Conforme In accordance	Conforme In accordance	Conforme In accordance		
		Planarità Flatness / Planéité / Oberflächenqualität / Planicidad / Плоскостность	± 0,5%, max 2 mm	Conforme In accordance	Conforme In accordance	Conforme In accordance		
STRUTTURA STRUCTURE STRUCTURE STRUKTUR ESTRUCTURA СТРУКТУРА		Assorbimento d'acqua - valore medio % Water absorption - average value % / Absorption d'eau - valeur moyenne % / Wasseraufnahme - Durchschnittswert % / Absorción de agua - valor medio % / Водопоглощение Среднее значение %	ISO 10545-3 ASTM C373 ≤ 0,5%	Conforme In accordance	Conforme In accordance	Conforme In accordance		
			Sforzo di rottura Breaking strenght / Force de rupture / Bruchlast / Esfuerzo di ruptura / Усилие на излом	ISO 10545-4 S ≥ 1300 N	S ≥ 2000 N	S ≥ 2000 N	S ≥ 2000 N	
			Resistenza alla flessione Bending strength / Résistance à la flexion / Biegefestigkeit / Resistencia a la flexión / Прочность при изгибе	R ≥ 35 N/mm ²	Conforme In accordance	Conforme In accordance	Conforme In accordance	
SBALZI TERMICI THERMAL SHOCK ECARTS DE TEMPÉRATURE TEMPERATURWECHSEL CHOQUES TÉRMICOS ТЕМПЕРАТУРНЫЕ ПЕРЕПАДЫ		Abrasione profonda Deep abrasion / Abrasion profonde / Tiefenabrieb / Abrasión profunda / Глубокое истирание	ISO 10545-6 ≤ 175mm ³	≤ 140mm ³	≤ 140mm ³	≤ 140mm ³		
			Coefficiente di dilatazione termica lineare Coefficient of thermal linear expansion / Coefficient de dilatation thermique linear / Wärmeausdehnungskoeffizient / Coeficiente de dilatación termica linear / Коэффициент теплового линейного расширения	ISO 10545-8	≤ 7 MK ⁻¹	≤ 7 MK ⁻¹	≤ 7 MK ⁻¹	
			Resistenza agli sbalzi termici Thermal shock resistance / Resistance aux variations thermiques / Temperaturwechselfähigkeit / Resistencia a las diferencias de temperatura / Сопротивление температурным перепадам	ISO 10545-9	Resistente Resistant	Resistente Resistant	Resistente Resistant	
SICUREZZA SAFETY SECURITÉ SICHERHEIT SEGURIDAD БЕЗОПАСНОСТЬ		Resistenza al gelo Resistance to frost / Résistance au gel / Frostbeständigkeit / Resistencia al hielo / Морозоустойчивость	ISO 10545-12	Resistente Resistant	Resistente Resistant	Resistente Resistant		
			Coefficiente di attrito dinamico Dynamic friction coefficient / Coefficient de frottement dynamique / Dynamischer Reibungskoeffizient / Coeficiente de fricción dinámica / Динамический коэффициент трения	METODO B.C.R.A.	D.M. 236 06/1989 μ > 0,40	μ > 0,40	μ > 0,40	
			Coefficiente di attrito statico Static coefficient of friction / Coefficient de frottement statique / Statischer Reibungskoeffizient / Coeficiente de fricción estatico / Статический коэффициент трения	DCOF BOT 3000	Slip resistant ≥ 0,42	Conforme In accordance	-	Conforme In accordance
			Classificazione antiscivolo Non-slip classification / Classification antidérapant / Bewertungsgruppe trittsicherheit / Clasificación antideslizante / Классификация противоскольжения	DIN 51130	In funzione dell'ambiente o della zona di lavoro. According to the space or the working area / Selon le lieu concerné ou la zone de travail / Je nach Raum oder Arbeitszone / Según el ambiente o de la zona de trabajo / В зависимости от среды или рабочей зоны	R9 (Atelier R10)	-	R11
RESISTENZA CHIMICA CHEMICAL RESISTANCE RÉSISTANCE AUX ATTQUES CHIMIQUES CHEMICALIENFESTIGKEIT RESISTENCIA A LOS PRODUCTOS QUÍMICOS ХИМИЧЕСКАЯ СТОЙКОСТЬ		Classificazione antiscivolo Non-slip classification / Classification antidérapant / Bewertungsgruppe trittsicherheit / Clasificación antideslizante / Классификация противоскольжения	DIN 51097	In funzione delle zone bagnate soggette a calpestio a piedi nudi. According to the wet area to be stepped on barefoot / Selon le type de surface mouillée parcourue pieds nus. / Je nach Nassbereich die barfuß zu betreten sind / Según de la zona mojada que se pisa con los pies desnudos / С учётом увлажняемых зон, предназначенных для ходьбы босиком	-	-	C(A+B+C)	
		Resistenza ai prodotti chimici di uso domestico e agli additivi per piscina Resistance to household chemicals and swimming pool salts / Résistance aux produits chimiques à usage domestique et aux adjuvants pour piscines / Beständigkeit gegen Haushaltchemikalien und Badewasserzusätze / Resistencia a los productos químicos de uso domestico o productos para la piscina / Сопротивляемость химическим средствам домашнего применения и добавкам для бассейна.	ISO 10545-13	UB Min.	Conforme In accordance	Conforme In accordance	Conforme In accordance	
		Resistenza a basse concentrazioni di acidi ed alcali Resistance to low concentrations of acids and alkalis / Résistance aux acides et aux alcalis à basse concentration / Beständigkeit gegen niedrigkonzentrierte Säuren und Laugen / Resistencia a concentración baja de acidos y álcali / Сопротивляемость кислотам и щелочам низкой концентрации	ULB Min.	ULB Min.	ULB Min.	ULB Min.		
	Resistenza alle macchie Stain resistance / Résistance aux taches / Baständigkeit gegen Fleckenbildung / Resistencia a las manchas / Стойкость к загрязнению	ISO 10545-14	5	5	5			

- Valore medio dei test condotti negli ultimi 24 mesi. Average rating of tests conducted during the last 24 months. Durchschnittswert der in den letzten 24 Monaten durchgeführten Tests. Valeur moyenne des essais menés au cours des 24 derniers mois. Valor medio de las pruebas llevadas a cabo en los últimos 24 meses. Среднее значение испытаний, проведенных в течение последних 24 месяцев.

La classificazione VShade indica il livello di stonizzazione del prodotto: la variazione cromatica tra le piastrelle di una stessa collezione. Nella tabella sottostante sono indicate le classi di stonizzazione: / The VShade ranking indicates the level of shading of the product: the variations in colour between the tiles in the same collection. The table below shows the shading classes: / La classification VShade indique le niveau de dénuançage du produit : la variation chromatique entre les carreaux d'une même collection. Dans le tableau ci-après sont indiquées les classes de dénuançage: / Die Einstufung VShade gibt die Abtönungsstufe des Produkts an: Die farbliche Abänderung zwischen den einzelnen Fliesen innerhalb einer Kollektion. In der nachstehenden Tabelle werden die Abtönungsklassen angeführt: / La clasificación VShade indica el nivel de destonización del producto: la variación cromática entre las baldosas de una misma colección. En la tabla de abajo se indican las clases de destonización: / Классификация VShade указывает на градацию тонов продукции – цветовую вариацию плитки в рамках одной коллекции. В приведенной ниже таблице указаны уровни различий тонов:

V1

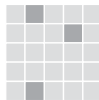

Leggera
Light

Légère
Leicht
Ligera
Низкий

V2



Moderata
Moderate

Modérée
Mäßig
Moderada
Средний

V3



Alta
High

Élevée
Hoch
Alta
Значительный

V4



Forte
Very High

Forte
Stark
Fuerte
Высокий

I colori e le caratteristiche estetiche dei materiali illustrati nel presente catalogo sono da ritenersi puramente indicativi.

Colours and optical features of the materials illustrated in this catalogue are to be regarded as mere indications.

Die Farben und die ästhetischen Eigenschaften der in diesem Katalog abgebildeten Produkte sind als reine Richtwerte zu betrachten.

Les coloris et les caractéristiques esthétiques des références illustrées dans le catalogue sont donnés à titre purement indicatif.

Los colores y las características ópticas de los materiales ilustrados en este catálogo deben ser mirados como indicaciones meras.

Цвета и эстетические характеристики описанных в настоящем каталоге материалов являются только ориентировочными.

Fap ceramiche si riserva di apportare modifiche e/o eliminare senza preavviso i prodotti declinando ogni responsabilità per danni diretti o indiretti derivanti da eventuali modifiche.

Fap ceramiche can change the indicated products without notice declining any responsibility for direct or in direct damage that depend on these changes.

Fap ceramiche se réserve le droit de modifier sans préavis les produits indiqués et décline toute responsabilité pour dommages directs ou indirects dus à éventuelles modifications.

Fap Ceramiche se reserva la facultad de modificar los productos sin preaviso, declinando cualquier responsabilidad por daños directos o indirectos que dependan de estos cambios.

Fap ceramiche kann die genannten Produkten ändern ohne Voranmeldung und lehnt dabei jegliche Verantwortung für die davon abhängenden direkten oder indirekten Schäden ab.

Компания "Fap ceramiche" сохраняет за собой право на внесение изменений в продукцию без предварительного уведомления, снимая с себя всякую ответственность за связанный с этими изменениями прямой или не прямой ущерб.

Fap ceramiche - 1st edition March 2016

È vietata la riproduzione anche parziale dell'opera in tutte le sue forme.

Reproduction of this printed catalogue, even partially, is prohibited.





**MOSCOW
SHOWROOM**

Via Ghiarola Nuova, 44 - 41042 Fiorano Modenese (MO) Italy
tel. +39 0536 837511 - fax +39 0536 837532 - fax estero +39 0536 837542
www.fapceramiche.com - info@fapceramiche.com



Hamovnichevskiy Val, 36 - Moscow Metro / Sportivnaya tel. +7 (495) 775 05 20
www.fapceramiche.ru - moscow@fapceramiche.com