

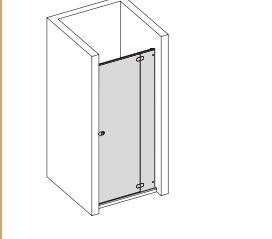

INVISIBLE HIGH-TECH
SHOWER CONCEPT

INDICE FLAT
INHALT FLAT
INDEX FLAT
INDICE FLAT

FN



FN + FB

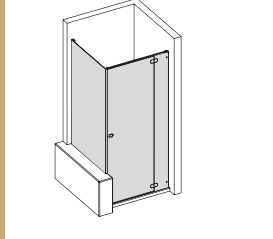

FI

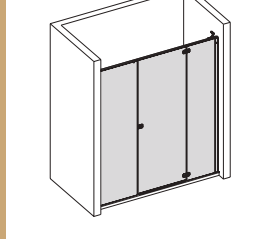

FT

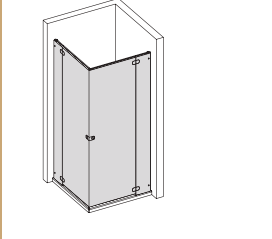

FT + FW

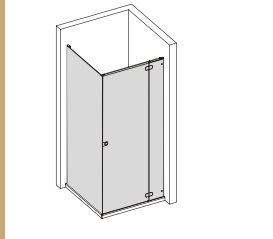

FR

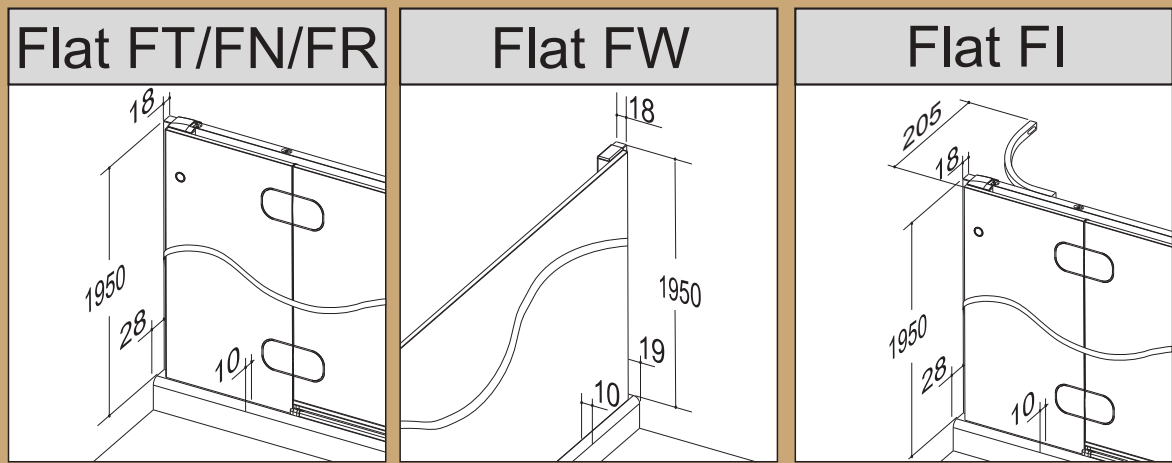
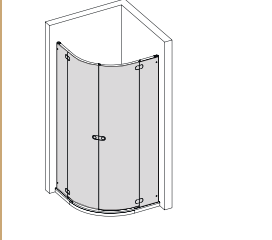

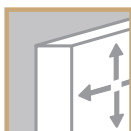

BOX DOCCIA SENZA TELAIO

- Design Studio Provox e Talocci
- Massima trasparenza con il sistema a cerniera incassata
- Pulizia ideale grazie al design completamente liscio (cerniere, profili e maniglia)
- Altezza 1950 mm e spessore vetro temperato 8 mm
- Regolazione graduale fino a 35 mm
- Tenuta stagna testata fino a 11 litri/minuto
- Montaggio facile con diverse guide di installazione
- Profilo a parete senza silicone e a scomparsa

RAHMENLOSE KABINEN

- Design Studio Provox und Talocci
- Maximale Transparenz durch die eingesetzte Scharniertechnik
- Ideale Reinigungseigenschaft durch flächenbündiges Design (Scharnier, Profil und Griff)
- Kabinenhöhe 1950 mm mit 8 mm Sicherheitsglas
- Stufenloser Verstellbereich bis 35 mm
- Getestete Wasserdichtheit von 11 Liter/Minute
- Einfachste Montage durch verschiedene Installationshilfen
- Silikonfreier Wandanschluß und Schattenprofil

FRAMELESS SHOWER ENCLOSURE

- Design Studio Provox and Talocci
- Maximum transparency through the assigned hinge technology
- Ideal to clean due to the completely flat design (hinges, profiles and handle)
- Height 1950 mm with 8 mm safety glass
- Smooth adjustment up to 35 mm and tested to be watertight up to 11 l/minute
- Simplest assembly through various installation aids
- Silicone free wall junction and shadow wall profile

CABINA DE DUCHA SIN PERFIL

- Design Studio Provox y Talocci
- Transparencia máxima por la tecnología de la bisagra encastrada
- Limpieza ideal por el diseño totalmente plano (bisagras, perfiles y maneta)
- Altura 1950 mm y cristal de 8 mm de espesor
- Extensibilidad plana hasta 35 mm
- No sale el agua al exterior hasta 11 l/minuto
- Montaje más simple con ayuda de instalación completa
- Fijación a pared sin necesidad de silicona y perfil mural oculto

FLAT FN + FB

ENTRATA FRONTALE + LATERALE PER VASCA
FRONTEINSTIEG + SEITENTEIL FÜR BADEWANNE
FRONT ENTRY + SIDE PANEL FOR BATHTUB
ENTRADA FRONTAL + LATERAL PARA BAÑERA





Descrizione Articolo Artikelbezeichnung Model description Descripción artículo	Articolo Artikel Model Código	Misura piatto doccia Tassenmaß Tray size Medidas del plato mm	Estensibilità porta Verstellbarkeit Tür Adjustability door Extensibilidad puerta mm	Estensibilità laterale Verstellbarkeit Seitenteil Adjustability side panel Extensibilidad lateral mm	Misura Maß Size Medidas mm A B C	
<p>Entrata frontale* Fronteinstieg* Front entry* Entrada frontal*</p> <p>Entrata frontale* Fronteinstieg* Front entry* Entrada frontal*</p> <p>NEW handle</p>	0001 FN - L/R	700	665 - 700		490 170 515	
	0002 FN - L/R	750	715 - 750		490 220 515	
	0003 FN - L/R	800	765 - 800		590 170 615	
	0004 FN - L/R	900	865 - 900		640 220 665	
	0005 FN - L/R	1000	965 - 1000		690 270 715	
	0007 FN - L/R	1200	1165 - 1200		690 470 715	
	1001 FN - L/R	700	665 - 700		490 170 515	
	1002 FN - L/R	750	715 - 750		490 220 515	
	1003 FN - L/R	800	765 - 800		590 170 615	
	1004 FN - L/R	900	865 - 900		640 220 665	
	1005 FN - L/R	1000	965 - 1000		690 270 715	
	1007 FN - L/R	1200	1165 - 1200		690 470 715	

*Il lato di montaggio della cerniera da definire nell'ordine (sinistra L - destra R) / Montageseite des Scharniers bei Bestellung definieren (links L - rechts R)
Define the hinge assembly side when ordering (left L - right R) / Lado bisagra de la asamblea se indican en el pedido (izquierda L - derecha R)

<p>Laterale per vasca Seitenteil für Badewanne Side panel for bathtub Pared lateral para bañera</p>	0015 FB**	700 - 1000		25			

** Articolo sempre fuori misura / Artikel ist immer Sondermaß / article is always special measure / artículo es siempre medida especial



FLAT FI

PORTA CENTRALE CON 2 LATERALI IN LINEA
ZENTRALE TÜR MIT 2 SEITENWÄNDEN IN LINIE
CENTRAL PIVOT DOOR WITH 2 IN-LINE FIXED PANELS
PUERTA CENTRALE CON 2 LATERALES FIJOS





High
GLASS



FI
1950



GH
High
GLASS

GL
8 mm

05



Descrizione Articolo Artikelbezeichnung Model description Descripción artículo	Articolo Artikel Model Código	Misura piatto doccia Tassenmaß Tray size Medidas del plato mm	Estensibilità Verstellbarkeit Adjustability Extensibilidad mm	Misura Maß Size Medidas mm
<p>Porta entrata frontale* Tür Fronteinstieg* Door front entry* Puerta entrada frontal*</p> <p>Porta entrata frontale* Tür Fronteinstieg* Door front entry* Puerta entrada frontal*</p> <p>NEW handle</p>	0009 FI-T - L/R	1400	1365 - 1415	270 690
	0011 FI-T - L/R	1600	1565 - 1615	470 690
	0013 FI-T - L/R	1800	1765 - 1815	470 690
	1009 FI-T - L/R	1400	1365 - 1415	270 690
	1011 FI-T - L/R	1600	1565 - 1615	470 690
	1013 FI-T - L/R	1800	1765 - 1815	470 690

*Il lato di montaggio della cerniera da definire nell'ordine (sinistra L - destra R) / Montageseite des Scharniers bei Bestellung definieren (links L - rechts R)
Define the hinge assembly side when ordering (left L - right R) / Lado bisagra de la asamblea se indican en el pedido (izquierda L - derecha R)

<p>Laterale in Linea con sostegno Seitenwand in Linie mit Stütze In-line Panel with support Lateral fijo con apoyo</p>	0009 FI-S	1400		415
	0011 FI-S	1600		415
	0013 FI-S	1800		615



FLAT FT

BOX AD ANGOLO
ECKEINSTIEG
CORNER ENTRY
CABINA ANGULAR



NEW
handle



Handle outside



Handle inside flush



High
GLASS



FT
1950



GH
High
GLASS

GL

8 mm

05

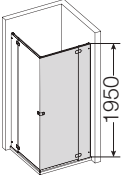

Descrizione Articolo Artikelbezeichnung Model description Descripción artículo	Articolo Artikel Model Código	Misura piatto doccia Tassenmaß Tray size Medidas del plato mm	Estensibilità Verstellbarkeit Adjustability Extensibilidad mm	Misura Maß Size Medidas mm		
				A	B	
 <p>Box ad angolo* EckEinstieg* Corner entry* Cabina angular*</p> <p>Box ad angolo* EckEinstieg* Corner entry* Cabina angular*</p> <p>NEW handle</p>	0001 FT - L/R	700	665 - 690	710	170	
	0002 FT - L/R	750	715 - 740	710	220	
	0003 FT - L/R	800	765 - 790	850	170	
	0004 FT - L/R	900	865 - 890	920	220	
	0005 FT - L/R	1000	965 - 990	990	270	
	0007 FT - L/R	1200	1165 - 1190	990	470	
	1001 FT - L/R	700	665 - 690	710	170	
	1002 FT - L/R	750	715 - 740	710	220	
	1003 FT - L/R	800	765 - 790	850	170	
	1004 FT - L/R	900	865 - 890	920	220	
	1005 FT - L/R	1000	965 - 990	990	270	
	1007 FT - L/R	1200	1165 - 1190	990	470	

*Usate 1 articolo cad. di FT-L e FT-R / Verwenden Sie je 1 x Artikel FT-L und FT-R / Use 1 article each FT-L and FT-R / Le rogamos de usar 1 cad. FT-L y FT-R

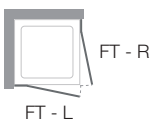

FLAT FT + FW

PORTA PIVOT CON LATERALE

SCHWINGTÜR MIT SEITENTEIL

PIVOT DOOR WITH SIDE PANEL

PUERTA PIVOTANTE CON PARED LATERAL





High GLASS



FT 1950 FW 1950



GH High GLASS GL 8 mm

05

Descrizione Articolo Artikelbezeichnung Model description Descripción artículo	Articolo Artikel Model Código	Misura piatto doccia Tassenmaß Tray size Medidas del plato mm	Estensibilità porta Verstellbarkeit Tür Adjustability door Extensibilidad puerta mm	Estensibilità laterale Verstellbarkeit Seitenteil Adjustability side panel Extensibilidad lateral mm	Misura Maß Size Medidas mm		
					A	B	C
<p>Porta pivot con sostegno* Drehtür mit Stütze* Pivot door with support* Puerta pivotante con soporte*</p> <p>Porta pivot con sostegno* Drehtür mit Stütze* Pivot door with support* Puerta pivotante con soporte*</p> <p>NEW handle</p>	0011 FT - L/R	700	665 - 690		490	170	515
	0012 FT - L/R	750	715 - 740		490	220	515
	0013 FT - L/R	800	765 - 790		590	170	615
	0014 FT - L/R	900	865 - 890		640	220	665
	0015 FT - L/R	1000	965 - 990		690	270	715
	0017 FT - L/R	1200	1165 - 1190		690	470	715
	1011 FT - L/R	700	665 - 690		490	170	515
	1012 FT - L/R	750	715 - 740		490	220	515
	1013 FT - L/R	800	765 - 790		590	170	615
	1014 FT - L/R	900	865 - 890		640	220	665
	1015 FT - L/R	1000	965 - 990		690	270	715
	1017 FT - L/R	1200	1165 - 1190		690	470	715

*Il lato di montaggio della cerniera da definire nell'ordine (sinistra L - destra R) / Montageseite des Scharniers bei Bestellung definieren (links L - rechts R)
Define the hinge assembly side when ordering (left L - right R) / Lado bisagra de la asamblea se indican en el pedido (izquierda L - derecha R)

<p>Laterale Seitenteil Side panel Pared lateral</p>	0001 FW	700		665 - 690			
	0002 FW	750		715 - 740			
	0003 FW	800		765 - 790			
	0004 FW	900		865 - 890			
	0005 FW	1000		965 - 990			

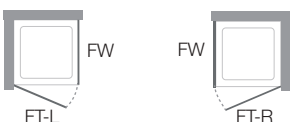

FLAT FR

BOX ROTONDO

RUNDKABINE

SHOWER ENCLOSURE CUBICLE

CABINA SEMICIRCULAR





High
GLASS



FR
1950



GH
High
GLASS

GL

8 mm

05



Descrizione Articolo Artikelbezeichnung Model description Descripción artículo	Articolo Artikel Model Código	Misura piatto doccia Tassenmaß Tray size Medidas del plato mm	Estensibilità Verstellbarkeit Adjustability Extensibilidad mm	Misura piatto installato Tasseneinbaumaß Tray installation measure Medidas del plato instalado mm	Misura Maß Size Medidas mm A B C
 <p>Box rotondo* Rundkabine* Shower enclosure cubicle* Cabina semicircular*</p>	6003 FR - L/R	800 R 550	765 - 790	775 - 800	850 170 470
	6004 FR - L/R	900 R 550	865 - 890	875 - 900	850 270 470
	6005 FR - L/R	1000 R 550	965 - 990	975 - 1000	850 370 470

*Usate 1 articolo cad. di FR-L e FR-R / Verwenden Sie je 1 x Artikel FR-L und FR-R / Use 1 article each FR-L and FR-R / Le rogamos de usar 1 cad. FR-L y FR-R

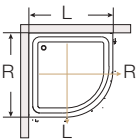

FR - L