

LOOK

PROVEX
comfort in the bathroom



EXCELLENT VALUE
WITH MANY
TECHNICAL FEATURES

INDICE LOOK
 INHALT LOOK
 INDEX LOOK
 INDICE LOOK

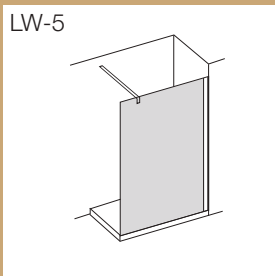
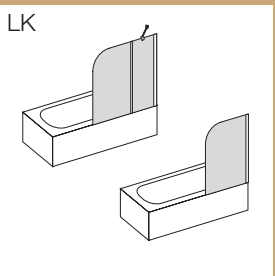
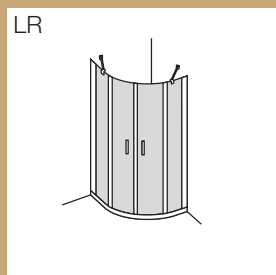
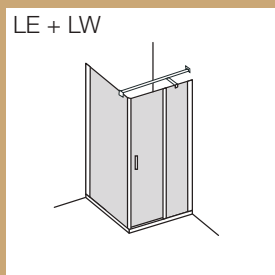
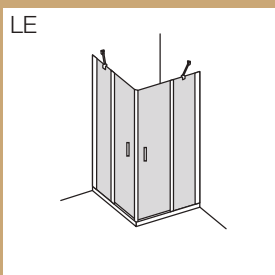
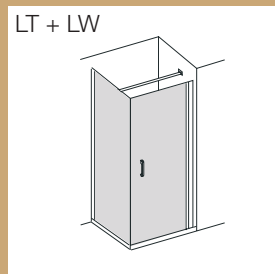
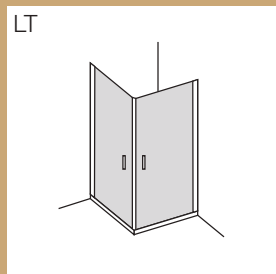
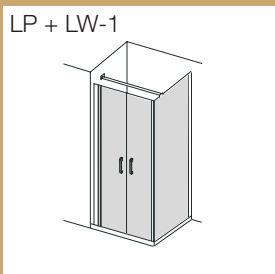
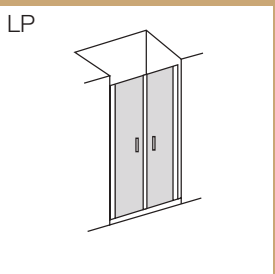
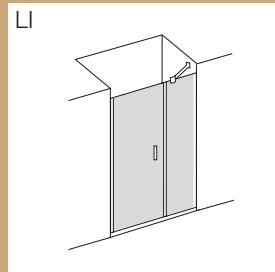
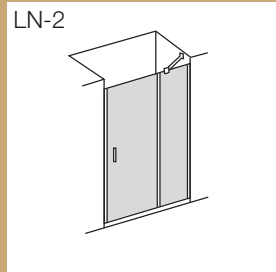
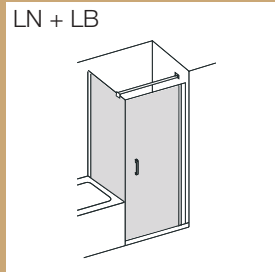
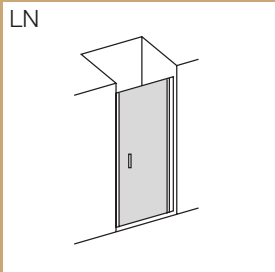

LOOK LN/LI/LP/LT

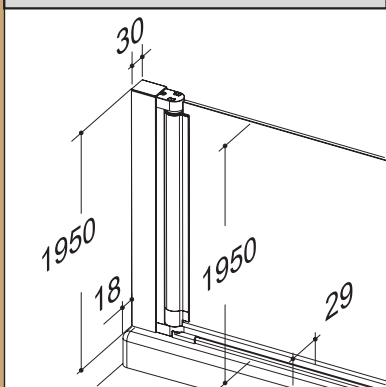

LOOK LN-2/LE/LR

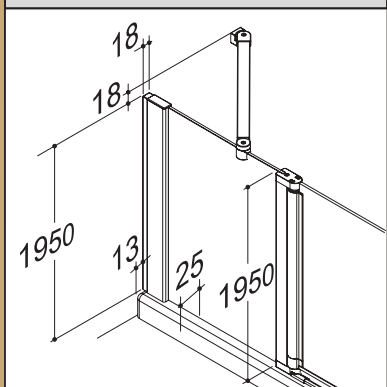

LOOK LW

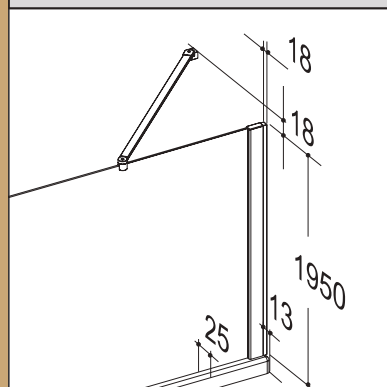



BOX CON PARZIALE TELAIO

- Design lineare e moderno senza profili orizzontali
- Ideale rapporto qualità-prezzo e vasta gamma di modelli
- Elementi porta basculante con meccanismo di sollevamento-abbassamento attivo
- Profilo a parete senza bisogno di silicone
- Estensibilità da 25-35 mm e vetro di sicurezza 6 mm
- Tenuta stagna testata a 11 litri/minuto
- Altezza continua della cabina 1950 mm (profilo e vetro)



TEILRAHMENKABINEN

- Lineares, modernes Design ohne Querverbinder
- Ideales Preis-Leistungsverhältnis und große Modellvielfalt
- Pendel-Türelemente mit aktivem Hebe-Senkmechanismus
- Silikonfreier Wandanschluss
- Verstellbereich von 25 – 35 mm und 6 mm Sicherheitsglas
- Getestete Wasserdichtheit von 11 Liter/Minute
- Durchgehende Kabinenhöhe 1950 mm (Profil und Glas)

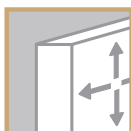

PARTIAL FRAMED SHOWER ENCLOSURE

- Linear, modern design without horizontal profiles
- Ideal price-performance ratio and wide range of models
- Saloon door elements with active rise and fall lifting mechanism
- Silicone-free wall junction
- Adjustment range 25-35 mm and 6 mm safety glass
- Tested to be watertight to 11 liters per minute
- Continuous cabin height 1950 mm (profile and glass)



CABINA CON PERFIL PARCIAL

- Diseño lineal y moderno sin perfil horizontal
- Buena relación calidad-precio y una amplia gama de modelos
- Mecanismo de puerta basculante de levantamiento/descenso permanente
- Fijación a pared sin necesidad de silicona
- Extensibilidad de 25 a 35 mm y vidrio de seguridad de 6 mm
- Estanqueidad para un caudal máximo 11 litros/ minuto
- Altura de la mampara 1950 mm (perfil + vidrio)

LOOK LN + LB

ENTRATA FRONTALE + LATERALE PER VASCA
FRONTEINSTIEG + SEITENWAND FÜR BADEWANNE
FRONT ENTRY + SIDE PANEL FOR BATHTUB
ENTRADA FRONTAL + PARED PARA BAÑERA





LN 1950	LB max.1800	
------------	----------------	--

OH High Glass	GH High Glass	SC	OG	GL	6 mm
------------------	------------------	----	----	----	------

28	05	
----	----	--

Descrizione Articolo Artikelbezeichnung Model description Descripción artículo	Articolo Artikel Model Código	Misura piatto doccia Tassenmaß Tray size Medidas del plato mm	Estensibilità Verstellbarkeit Adjustability Extensibilidad mm	Misura Maß Size Medidas mm		
				A	B	
<p>Porta basculante singola Pendeltür 1-teilig Saloon door single Puerta basculante</p>	0001 LN	700	668 - 703	590	620	
	0002 LN	750	718 - 753	640	670	
	0003 LN	800	768 - 803	690	720	
	0004 LN	900	868 - 903	790	820	
	0005 LN	1000	968 - 1003	890	920	
<p>Laterale per vasca Seitenteil für Badewanne Side panel for bathtub Pared lateral para bañera</p>	0015 LB**	700 - 1000	25			

** Articolo é sempre un fuori misura / Artikel ist immer Sondermaß / article is always special measure / artículo es siempre medida especial

	<p>Indicare sempre bordo piatto fino bordo vasca/muretto Oberkante Duschtasse bis Badewanne/Mauer immer angeben Indicate always shower tray to bathtub panel/wall Indique siempre borde superior plato de ducha y bañera/muro</p>
--	--

LOOK LN-2

PORTA CON FISSO IN LINEA

TÜR MIT FESTFELD IN LINIE

PIVOT DOOR WITH IN-LINE FIXED PANEL

PUERTA CON LATERAL FIJO





High
GLASS



LN-2 LB
1950 max.1800

OH GH SC OG GL 6mm
High Glass High Glass

28 05

Descrizione Articolo Artikelbezeichnung Model description Descripción artículo	Articolo Artikel Model Código	Misura piatto doccia Tassenmaß Tray size Medidas del plato mm	Estensibilità Verstellbarkeit Adjustability Extensibilidad mm	Misura Maß Size Medidas mm
				A B
<p>Porta basculante in linea Pendeltür mit Festfeld in Linie Saloon door with in-line fixed panel Puerta basculante con lateral fijo</p> <p>IN OUT</p>	2004 LN	900	870 - 905	565 310
	2005 LN	1000	970 - 1005	565 410
	2006 LN	1100	1070 - 1105	665 410
	2007 LN	1200	1170 - 1205	665 510
	2009 LN	1400	1370 - 1405	665 710
<p>Laterale per vasca Seitenteil für Badewanne Side panel for bathtub Pared lateral para bañera</p>	0015 LB**	700 - 1000	25	

	<p>Bordo piatto fino bordo vasca/muretto Oberkante Duschtasse bis Badewanne/Mauer Shower tray to bathtub panel/wall Borde superior plato de ducha y bañera/muro</p>
--	--

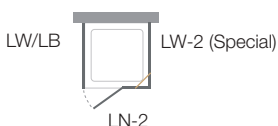

LOOK LI

PORTA CON FISSO IN LINEA

TÜR MIT FESTFELD IN LINIE

PIVOT DOOR WITH IN-LINE FIXED PANEL

PUERTA CON LATERAL FIJO





High GLASS



LI 1950

OH High Glass GH High Glass SC OG GL 6mm

28 05

Descrizione Articolo Artikelbezeichnung Model description Descripción artículo	Articolo Artikel Model Código	Misura piatto doccia Tassenmaß Tray size Medidas del plato mm	Estensibilità Verstellbarkeit Adjustability Extensibilidad mm	Misura Maß Size Medidas mm
<p>Porta basculante in linea Pendeltür mit Festfeld in Linie Saloon door with in-line fixed panel Puerta basculante con lateral fijo</p>	0005 LI	1000	955 - 1005	330 590 620
	0006 LI	1100	1055 - 1105	330 690 720
	0007 LI	1200	1155 - 1205	330 790 820
	0009 LI	1400	1355 - 1405	530 790 820



LOOK LP

PORTA BASCULANTE
PENDELTÜR
SALOON DOOR
PUERTA BASCULANTE





Descrizione Articolo Artikelbezeichnung Model description Descripción artículo	Articolo Artikel Model Código	Misura piatto doccia Tassenmaß Tray size Medidas del plato mm	Estensibilità Verstellbarkeit Adjustability Extensibilidad mm	Misura Maß Size Medidas mm A
 <p>Porta basculante doppia Pendeltür 2-teilig Saloon door double Puerta basculante doble</p>	0001 LP	700	657 - 707	540
	0002 LP	750	707 - 757	590
	0003 LP	800	757 - 807	640
	0004 LP	900	857 - 907	740
	0005 LP	1000	957 - 1007	840
	0007 LP	1200	1157 - 1207	1040

LOOK LP + LW-1

PORTA BASCULANTE CON LATERALE
PENDELTÜR MIT SEITENTEIL
SALOON DOOR WITH SIDE PANEL
PUERTA BASCULANTE CON LATERAL





Descrizione Articolo Artikelbezeichnung Model description Descripción artículo	Articolo Artikel Model Código	Misura piatto doccia Tassenmaß Tray size Medidas del plato mm	Estensibilità Verstellbarkeit Adjustability Extensibilidad mm	Misura centro vetro Mitte Glasmaß Glass size middle Medida vidrio centro mm	Misura Maß Size Medidas mm A	
<p>Porta basculante Pendeltür Saloon door Puerta basculante</p>	0001 LP	700	677 - 727	662 - 712	540	
	0002 LP	750	727 - 777	712 - 762	590	
	0003 LP	800	777 - 827	762 - 812	640	
	0004 LP	900	877 - 927	862 - 912	740	
	0005 LP	1000	977 - 1027	962 - 1012	840	
	0007 LP	1200	1177 - 1227	1162 - 1212	1040	
<p>Laterale per porta basculante Seitenwand für Pendeltür Side panel for saloon door Lateral para puerta basculante</p>	1001 LW	700	670 - 695	655 - 680		
	1002 LW	750	720 - 745	705 - 730		
	1003 LW	800	770 - 795	755 - 780		
	1004 LW	900	870 - 895	855 - 880		
	1005 LW	1000	970 - 995	955 - 980		

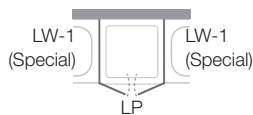
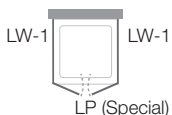

LOOK LT

BOX AD ANGOLO
ECKEINSTIEG
CORNER ENTRY
CABINA ANGULAR





Descrizione Articolo Artikelbezeichnung Model description Descripción artículo	Articolo Artikel Model Código	Misura piatto doccia Tassenmaß Tray size Medidas del plato mm	Estensibilità Verstellbarkeit Adjustability Extensibilidad mm	Misura centro vetro Mitte Glasmaß Glass size middle Medida vidrio centro mm	Misura Maß Size Medidas mm A
 <p>Box ad angolo* EckEinstieg* Corner entry* Cabina angular*</p>	0001 LT	700	665 - 690	650 - 675	840
	0002 LT	750	715 - 740	700 - 725	910
	0003 LT	800	765 - 790	750 - 775	980
	0004 LT	900	865 - 890	850 - 875	1125
	0005 LT	1000	965 - 990	950 - 975	1265

*Usate 2 articoli LT per il box completo / Verwenden Sie 2 x Artikel LT für die komplette Kabine / Use 2 article LT for the complete box / Le rogamos de usar 2 x LT per para la cabina completa

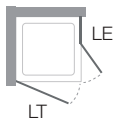

LOOK **LT + LW**

PORTA PIVOT CON LATERALE
SCHWINGTÜR MIT SEITENTEIL
PIVOT DOOR WITH SIDE PANEL
PUERTA PIVOTANTE CON LATERAL





High
GLASS



LT 1950	LW 1950	
------------	------------	--

OH High Glass	GH High Glass	SC	OG	GL	6 mm
------------------	------------------	----	----	----	------

28	05	
----	----	--

Descrizione Articolo Artikelbezeichnung Model description Descripción artículo	Articolo Artikel Model Código	Misura piatto doccia Tassenmaß Tray size Medidas del plato mm	Estensibilità Verstellbarkeit Adjustability Extensibilidad mm	Misura centro vetro Mitte Glasmaß Glass size middle Medida vidrio centro mm	Misura Maß Size Medidas mm A B
<p>Porta basculante Pendeltür Saloon door Puerta basculante</p> <p>IN OUT</p>	0001 LT	700	670 - 695	655 - 680	590 620
	0002 LT	750	720 - 745	705 - 730	640 670
	0003 LT	800	770 - 795	755 - 780	690 720
	0004 LT	900	870 - 895	855 - 880	790 820
	0005 LT	1000	970 - 995	955 - 980	890 920
<p>Laterale con sostegno Seitenwand mit Stütze Side panel with support Pared lateral con soporte</p>	0001 LW	700	670 - 695	655 - 680	
	0002 LW	750	720 - 745	705 - 730	
	0003 LW	800	770 - 795	755 - 780	
	0004 LW	900	870 - 895	855 - 880	
	0005 LW	1000	970 - 995	955 - 980	
	0007 LW	1200	1170 - 1195	1155 - 1180	

LOOK LE

BOX AD ANGOLO
ECKKABINE
CORNER ENTRY
CABINA ANGULAR





Descrizione Articolo Artikelbezeichnung Model description Descripción artículo	Articolo Artikel Model Código	Misura piatto doccia Tassenmaß Tray size Medidas del plato mm	Estensibilità Verstellbarkeit Adjustability Extensibilidad mm	Misura centro vetro Mitte Glasmaß Glass size middle Medida vidrio centro mm	Misura Maß Size Medidas mm		
					A	B	C
 <p>Box ad angolo* Eckkabine* Corner entry* Cabina angular*</p>	0001 LE	700	665 - 690	650 - 675	540	380	310
	0002 LE	750	715 - 740	700 - 725	610	430	310
	0003 LE	800	765 - 790	750 - 775	660	480	310
	0004 LE	900	865 - 890	850 - 875	800	580	310
	0005 LE	1000	965 - 990	950 - 975	940	680	310
	0006 LE	1100	1065 - 1090	1050 - 1075	940	680	410
	0007 LE	1200	1165 - 1190	1150 - 1175	940	680	510

*Usate 2 articoli LE per il box completo / Verwenden Sie 2 x Artikel LE für die komplette Kabine / Use 2 article LE for the complete box / Le rogamos de usar 2 x LE per para la cabina completa

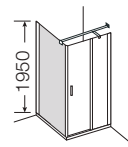
 <p>Laterale con sostegno Seitenwand mit Stütze Side panel with support Pared lateral con soporte</p>	0001 LW	700	670 - 695	655 - 680			
	0002 LW	750	720 - 745	705 - 730			
	0003 LW	800	770 - 795	755 - 780			
	0004 LW	900	870 - 895	855 - 880			
	0005 LW	1000	970 - 995	955 - 980			
	0006 LW	1100	1070 - 1095	1055 - 1080			
	0007 LW	1200	1170 - 1195	1155 - 1180			

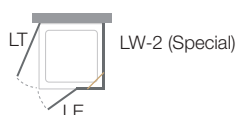
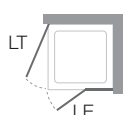

LOOK LR

BOX ROTONDO
RUNDKABINE
SHOWER ENCLOSURE CUBICLE
CABINA SEMICIRCULAR





Descrizione Articolo Artikelbezeichnung Model description Descripción artículo	Articolo Artikel Model Código	Misura piatto doccia Tassenmaß Tray size Medidas del plato mm	Estensibilità Verstellbarkeit Adjustability Extensibilidad mm	Misura piatto installato Tasseneinbaumaß Tray installation measure Medidas del plato instalado mm	Misura Maß Size Medidas mm		
					A	B	C
 <p>Box rotondo* Rundkabine* Shower enclosure cubicle* Cabina semicircular*</p>	6003 LR	800 R 550	770 - 795	780 - 805	620	270	350
	6004 LR	900 R 550	870 - 895	880 - 905	620	370	350
	6005 LR	1000 R 550	970 - 995	980 - 1005	620	470	350

*Usate 2 articoli LR per il box completo / Verwenden Sie 2 x Artikel LR für die komplette Kabine / Use 2 article LR for the complete box / Le rogamos de usar 2 x LR per para la cabina completa

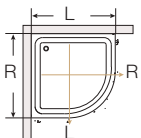

misura vetro Glasmaß glass size - 15 mm see page 20	Per un montaggio a pavimento l'estensibilità sopra indicata si riduce di Bei bodenbündiger Montage reduziert sich der oben angeführte Verstellbereich um For an installation on the floor adjustability mentioned above reduces by
---	---

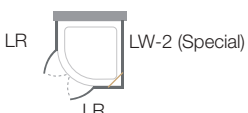

LOOK LW-5

PARETE DOCCIA CON SOSTEGNO
RAUMABTRENNUNG MIT STÜTZE
SHOWER SCREEN WITH SUPPORT
SEPARA EL ESPACIO CON APOYO





Descrizione Articolo Artikelbezeichnung Model description Descripción artículo	Articolo Artikel Model Código	Misura Maß Size Medidas mm	Estensibilità Verstellbarkeit Adjustability Extensibilidad mm		Misura Maß Size Medidas mm		
		A	A	B			
<p>Parete doccia con sostegno Raumabtrennung mit Stütze Shower screen with support Separa el espacio con apoyo</p>	5005 LW*	1000	985 - 1010	450 - 1200*			
	5007 LW*	1200	1185 - 1210	450 - 1200*			
	5009 LW*	1400	1385 - 1410	450 - 1200*			
	5037 LW*	SPECIAL	600 - 1209	450 - 1200*			
	5079 LW*	SPECIAL	1210 - 1410	450 - 1200*			

* Sostegno può essere montato anche a 45°/Stütze kann auch diagonal montiert werden/support can be installed diagonal/ Apoyo también puede ser montado en diagonal



LOOK LK

ANTINA PER VASCA
KLAPPWAND FÜR BADEWANNE
PIVOTING BATHSCREEN
HOJA PARA BAÑERA





High
GLASS



LK
1400



OH High Glass	GH High Glass	SC	OG	GL	6 mm
------------------	------------------	----	----	----	------

28	05	
----	----	--

Descrizione Articolo Artikelbezeichnung Model description Descripción artículo	Articolo Artikel Model Código	Misura vasca Wannenmaß Bathtub size Medidas de la bañera mm	Estensibilità Verstellbarkeit Adjustability Extensibilidad mm	Misura Maß Size Medidas mm		Misura Maß Size Medidas mm	
				A	B		
Antina per vasca a 1 anta* 1-teilige Klappwand* Single pivoting bathscreen* Hoja para bañera 1 elemento*	0001 LK - L/R	700	708 - 733			min. 665	
	0002 LK - L/R	750	758 - 783			min. 715	
	0003 LK - L/R	800	808 - 833			min. 765	
Antina per vasca a 2 ante* 2-teilige Klappwand* Double pivoting bathscreen* Hoja para bañera 2 elementos*	2001 LK - L/R	700	1078 - 1103	440	650	min. 665	
	2002 LK - L/R	750	1128 - 1153	440	700	min. 715	
	2003 LK - L/R	800	1178 - 1203	440	750	min. 765	

*Il lato di montaggio da definire nell'ordine (sinistra L - destra R) / Montageseite bei Bestellung definieren (links L - rechts R)
 Define the assembly side when ordering (left L - right R) / Lado de la asamblea se indican en el pedido (izquierda L - derecha R)

