

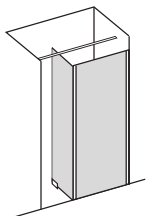

FLEXIBLE AND INNOVATIVE
SOLUTIONS FOR YR.
EXTRA-LARGE SHOWER AREA

INDICE MODULA
INHALT MODULA
INDEX MODULA
INDICE MODULA

MF



MV

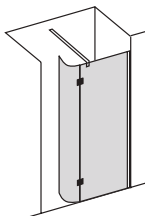

ME

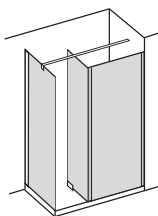

MR-1

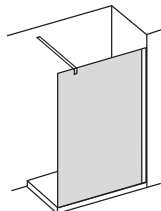

MR-2

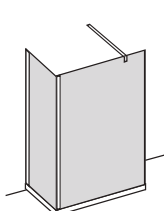

MR-3

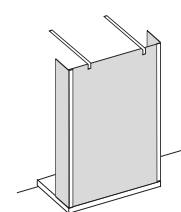

MR-4

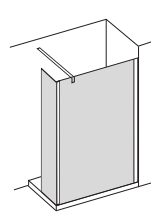

MR-5

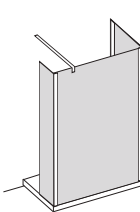

MX-1

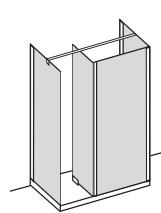

MX-2

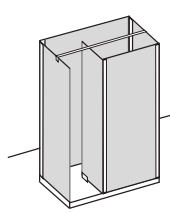

Modula

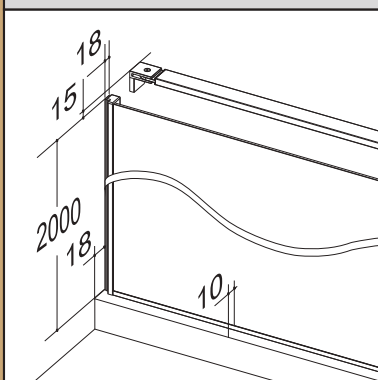

NEW
200 cm



BOX DOCCIA SENZA TELAIO

- Sistema modulare per docce di ampie misure
- Design Studio Talocci
- Montaggio fattibile a filo pavimento oppure su piatto doccia
- Altezza 2000 mm, estensibilità fino a 50 mm e vetro di sicurezza da 8 mm
- Tenuta stagna testata a 11 litri/minuto
- Profilo a parete senza bisogno di silicone
- Con attaccapanni e profilo murale a scomparsa
- Con profilo per la compensazione del pavimento fuori livello



RAHMENLOSE KABINEN

- Modulares System für Großraumduschen
- Design Studio Talocci
- Montage bodenbündig oder auf Duschtasse möglich
- Kabinenhöhe 2000 mm, Verstellbereich bis 50 mm und 8 mm Sicherheitsglas
- Getestete Wasserdichtheit von 11 Liter/Minute
- Silikonfreier Wandanschluss
- Mit Kleiderhaken ausgestattet und Schattenprofil an der Wandbefestigung
- Bodenprofil zum Ausgleich von Unebenheiten



FRAMELESS SHOWER ENCLOSURE

- Modular system for extra-large shower areas
- Design Studio Talocci
- Assembly is possible on a shower tray or flush to the floor
- Enclosures height of 2000 mm, adjustability up to 50 mm and 8 mm safety glass
- Tested to be watertight 11 litres per minute
- Silicone free wall junction
- With coat hook and shadow profile on the wall side
- With floor profile to compensate for unevenness

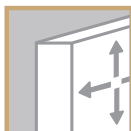

CABINA DE DUCHA SIN PERFIL

- Sistema modular para las duchas de medidas grandes
- Design Studio Talocci
- Permite instalarla al suelo o sobre el plato de ducha
- Altura 2000 mm, extensibilidad hasta 50 mm y 8 mm vidrio de seguridad
- No sale el agua al exterior de 11 litros/minutos
- Fijación a pared sin necesidad de silicona
- Con percha y perfil mural oculto
- El perfil permite ajustar las desigualdades



MODULA MF

ENTRATA FRONTALE
FRONTEINSTIEG
FRONT ENTRY
ENTRADA FRONTAL





Descrizione Articolo Artikelbezeichnung Model description Descripción artículo	Articolo Artikel Model Código	Misure Maße Sizes Medidas mm	Estensibilità Verstellbarkeit Adjustability Extensibilidad mm	Misura Maß Size Medidas mm		
		A	A	D	E	
 Entrata frontale Fronteinstieg Front entry Entrada frontal	0009 MF	1400	1365 - 1405	250	560	
	0011 MF	1600	1565 - 1605	250	560	

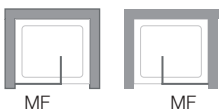

MODULA **MV**

ENTRATA FRONTALE CON 1 PANNELLO PIVOTANTE
FRONTEINSTIEG MIT 1 DREHELEMENT
FRONT ENTRY WITH 1 PIVOTING ELEMENT
ENTRADA FRONTAL CON 1 ELEMENTO PIVOTANTE





Descrizione Articolo Artikelbezeichnung Model description Descripción artículo	Articolo Artikel Model Código	Misure Maße Sizes Medidas mm A**	Estensibilità Verstellbarkeit Adjustability Extensibilidad mm B	Estensibilità Verstellbarkeit Adjustability Extensibilidad mm C	Misura Maß Size Medidas mm E			
<p>Entrata frontale con 1 pannello pivotante Fronteinstieg mit 1 Drehelement Front entry with 1 pivoting element Entrada frontal con 1 elemento pivotante</p>	1007 MV - L/R*	1200**	650 - 1275	860 - 900	460			
	1009 MV - L/R*	1400**	650 - 1275	860 - 900	660			

*Indicare nell'ordine la posizione (sinistra L - destra R) dell'attacco murale / In der Bestellung die Wandanschlussseite definieren (links L - rechts R)
Define the assembly side when ordering (left L - right R) / Lado de la asamblea se indican en el pedido (izquierda L - derecha R)

** Misura minima in nicchia / Minimum Nischenmaß / Minimum size front entry / Medida mínima en nicho = **1055 mm**



MODULA **ME**

ENTRATA FRONTALE CON LATERALE

FRONTEINSTIEG MIT SEITENTEIL

FRONT ENTRY WITH SIDE PANEL

ENTRADA FRONTAL CON LATERAL



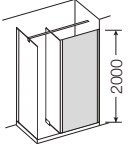
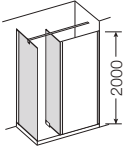

Descrizione Articolo Artikelbezeichnung Model description Descripción artículo	Articolo Artikel Model Código	Misure Maße Sizes Medidas mm		Estensibilità Verstellbarkeit Adjustability Extensibilidad mm		Misura Maß Size Medidas mm	
		A	B	A	B	D	E
 <p>Entrata frontale con sostegno Fronteinstieg mit Stütze Front entry with support Entrada frontal con apoyo</p>	0009 ME-F	1400		1360 - 1400		550	
	0011 ME-F	1600		1560 - 1600		550	
 <p>Laterali con supporto vetro Seitenwände mit Glashalterung Side panels with bezel Laterales con bisel</p>	0002 ME-S		750		725 - 750	250	
	0003 ME-S		800		775 - 800	250	
	0004 ME-S		900		875 - 900	250	
	0005 ME-S		1000		975 - 1000	250	



MODULA **MR-1**

PARETE DOCCIA CON SOSTEGNO
RAUMABTRENNUNG MIT STÜTZE
SHOWER SCREEN WITH SUPPORT
SEPARA EL ESPACIO CON APOYO





Descrizione Articolo Artikelbezeichnung Model description Descripción artículo	Articolo Artikel Model Código	Misure Maße Sizes Medidas mm	Estensibilità Verstellbarkeit Adjustability Extensibilidad mm		Misura Maß Size Medidas mm	
		A	A	B		
<p>Parete doccia con sostegno (montaggio su piatto doccia) Raumabtrennung mit Stütze (Montage auf Duschtasse) Shower screen with support (installation on tray) Separa el espacio con apoyo (montaje para plato)</p>	1005 MR	1000	955 - 980	650 - 1275		
	1006 MR	1100	1055 - 1080	650 - 1275		
	1007 MR	1200	1155 - 1180	650 - 1275		
	1008 MR	1300	1255 - 1280	650 - 1275		
	1009 MR	1400	1355 - 1380	650 - 1275		
<p>Parete doccia con sostegno (montaggio a pavimento) Raumabtrennung mit Stütze (für Bodenmontage) Shower screen with support (installation on floor) Separa el espacio con apoyo (para montaje sin plato)</p>	1005 MR +	1000	990 - 1015	650 - 1275		
	1006 MR +	1100	1090 - 1115	650 - 1275		
	1007 MR +	1200	1190 - 1215	650 - 1275		
	1008 MR +	1300	1290 - 1315	650 - 1275		
	1009 MR +	1400	1390 - 1415	650 - 1275		
	1037 MR	SPECIAL	600 - 1209	650 - 1275		
	1079 MR	SPECIAL	1210 - 1410	650 - 1275		



MODULA MR-2

PARETE DOCCIA CON LATERALE
RAUMABTRENNUNG MIT SEITENTEIL
SHOWER SCREEN WITH SIDE PANEL
SEPARA EL ESPACIO CON LATERAL





Descrizione Articolo Artikelbezeichnung Model description Descripción artículo	Articolo Artikel Model Código	Misure Maße Sizes Medidas mm		Estensibilità Verstellbarkeit Adjustability Extensibilidad mm		Misura Maß Size Medidas mm	
		A	B	A	B		
<p>Parete doccia (montaggio su piatto doccia) Raumabtrennung (Montage auf Duschtasse) Shower screen (installation on tray) Separa el espacio (montaje para plato)</p>	2005 MR-F	1000		960			
	2006 MR-F	1100		1060			
	2007 MR-F	1200		1160			
	2008 MR-F	1300		1260			
	2009 MR-F	1400		1360			
<p>Parete doccia (montaggio a pavimento) Raumabtrennung (für Bodenmontage) Shower screen (installation on floor) Separa el espacio (para montaje sin plato)</p>	2005 MR-F +	1000		995			
	2006 MR-F +	1100		1095			
	2007 MR-F +	1200		1195			
	2008 MR-F +	1300		1295			
	2009 MR-F +	1400		1395			
<p>Laterale con sostegno Seitenteil mit Stütze Side panel with support Lateral con apoyo</p>	2702 MR-S		750		725 - 750		
	2703 MR-S		800		775 - 800		
	2704 MR-S		900		875 - 900		
	2705 MR-S		1000		975 - 1000		

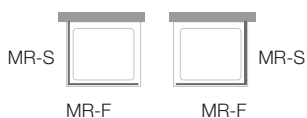

MODULA MR-3

PARETE DOCCIA CON 2 LATERALI CORTI
RAUMABTRENNUNG MIT 2 KURZEN SEITENTEILEN
SHOWER SCREEN WITH 2 SHORT SIDE PANELS
SEPARA EL ESPACIO CON 2 LATERALES CORTOS





Descrizione Articolo Artikelbezeichnung Model description Descripción artículo	Articolo Artikel Model Código	Misure Maße Sizes Medidas mm A	Estensibilità Verstellbarkeit Adjustability Extensibilidad mm A B		Misura Maß Size Medidas mm E			
			A	B				
<p>Parete doccia con 2 laterali corti (montaggio su piatto doccia) Raumabtrennung mit 2 kurzen Seitenteilen (Montage auf Duschtasse) Shower screen with 2 short side panels (installation on tray) Separa el espacio con 2 laterales cortos (montaje para plato)</p>	3005 MR	1000	970	650 - 1275	250			
	3007 MR	1200	1170	650 - 1275	250			
	3009 MR	1400	1370	650 - 1275	250			
<p>Parete doccia con 2 laterali corti (montaggio a pavimento) Raumabtrennung mit 2 kurzen Seitenteilen (für Bodenmontage) Shower screen with 2 short side panels (installation on floor) Separa el espacio con 2 laterales cortos (para montaje sin plato)</p>	3005 MR +	1000	1005	650 - 1275	250			
	3007 MR +	1200	1205	650 - 1275	250			
	3009 MR +	1400	1405	650 - 1275	250			

MODULA **MR-4**

PARETE DOCCIA CON 1 LATERALE CORTO
RAUMABTRENNUNG MIT 1 KURZEN SEITENTEIL
SHOWER SCREEN WITH 1 SHORT SIDE PANEL
SEPARA EL ESPACIO CON 1 LATERAL CORTO





Descrizione Articolo Artikelbezeichnung Model description Descripción artículo	Articolo Artikel Model Código	Misure Maße Sizes Medidas mm A	Estensibilità Verstellbarkeit Adjustability Extensibilidad mm A B		Misura Maß Size Medidas mm E			
			A	B				
<p>Parete doccia con 1 laterale corto (montaggio su piatto doccia) Raumabtrennung mit 1 kurzen Seitenteil (Montage auf Duschtasse) Shower screen with 2 short side panel (installation on tray) Separa el espacio con 1 lateral corto (montaje para plato)</p>	4005 MR	1000	965 - 990	650 - 1275	250			
	4006 MR	1100	1065 - 1090	650 - 1275	250			
	4007 MR	1200	1165 - 1190	650 - 1275	250			
	4008 MR	1300	1265 - 1290	650 - 1275	250			
	4009 MR	1400	1365 - 1390	650 - 1275	250			
<p>Parete doccia con 1 laterale corto (montaggio a pavimento) Raumabtrennung mit 1 kurzen Seitenteil (für Bodenmontage) Shower screen with 1 short side panel (installation on floor) Separa el espacio con 1 lateral corto (para montaje sin plato)</p>	4005 MR +	1000	1000 - 1025	650 - 1275	250			
	4006 MR +	1100	1100 - 1125	650 - 1275	250			
	4007 MR +	1200	1200 - 1225	650 - 1275	250			
	4008 MR +	1300	1300 - 1325	650 - 1275	250			
	4009 MR +	1400	1400 - 1425	650 - 1275	250			



MODULA **MR-5**

PARETE DOCCIA CON 1 LATERALE LUNGO E 1 CORTO

RAUMABTRENNUNG MIT 1 KURZEN UND 1 LANGEN SEITENTEIL

SHOWER SCREEN WITH 1 SHORT AND 1 LONG SIDE PANEL

SEPARA EL ESPACIO CON 1 LATERAL CORTO Y LARGO





High
GLASS



MR-5
2000

GH High GLASS **EH** High GLASS **GE** **GL** 8 mm

05

Descrizione Articolo Artikelbezeichnung Model description Descripción artículo	Articolo Artikel Model Código	Misure Maße Sizes Medidas mm		Estensibilità Verstellbarkeit Adjustability Extensibilidad mm		Misura Maß Size Medidas mm		
		A	B	A	B	D	E	
<p>Parete doccia (montaggio su piatto doccia) Raumabtrennung (Montage auf Duschtasse) Shower screen (installation on tray) Separa el espacio (montaje para plato)</p>	5005 MR-F	1000		970				
	5007 MR-F	1200		1170				
	5009 MR-F	1400		1370				
<p>Parete doccia (montaggio a pavimento) Raumabtrennung (für Bodenmontage) Shower screen (installation on floor) Separa el espacio (para montaje sin plato)</p>	5005 MR-F +	1000		1005				
	5007 MR-F +	1200		1205				
	5009 MR-F +	1400		1405				
<p>Laterali con sostegno Seitenteile mit Stütze Side panels with support Laterales con apoyo</p>	5702 MR-S		750		725 - 750	550	250	
	5703 MR-S		800		775 - 800	600	250	
	5704 MR-S		900		875 - 900	550	250	
	5705 MR-S		1000		975 - 1000	650	250	



MODULA **MX-1**

ENTRATA FRONTALE CON 2 LATERALI
FRONTEINSTIEG MIT 2 SEITENTEILEN
FRONT ENTRY WITH 2 SIDE PANELS
ENTRADA FRONTAL CON 2 LATERALES





High
GLASS



MX-1
2000

GH High GLASS **EH** High GLASS **GE** **GL** 8 mm

05

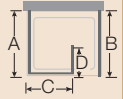
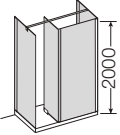
Descrizione Articolo Artikelbezeichnung Model description Descripción artículo	Articolo Artikel Model Código	Misure Maße Sizes Medidas mm	Misura Maß Size Medidas mm 
	Entrata frontale con 2 laterali e sostegno Fronteinstieg mit 2 Seitenteilen und Stütze Front entry with 2 side panels and support Entrada frontal con 2 laterales y apoyo	0030 MX Variabile - variabel - variable - variable	

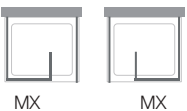

MODULA **MX-2**

ENTRATA FRONTALE CON 3 LATERALI
FRONTEINSTIEG MIT 3 SEITENTEILEN
FRONT ENTRY WITH 3 SIDE PANELS
ENTRADA FRONTAL CON 3 LATERALES



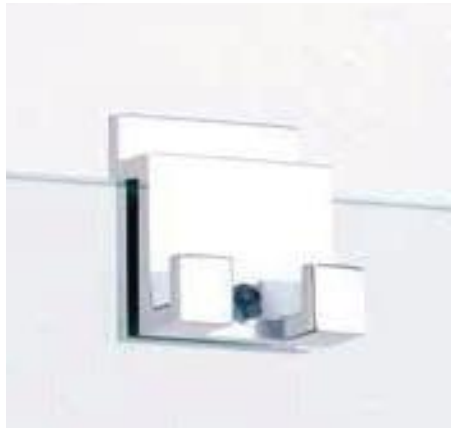

High
GLASS



MX-2
2000

GH High GLASS	EH High GLASS	GE	GL	8 mm
----------------------------	----------------------------	-----------	-----------	-------------

05

Descrizione Articolo Artikelbezeichnung Model description Descripción artículo	Articolo Artikel Model Código	Misure Maße Sizes Medidas mm	Misura Maß Size Medidas mm
	Entrata frontale con 3 laterali Fronteinstieg mit 3 Seitenteilen Front entry with 3 side panels Entrada frontal con 3 laterales	0040 MX Variabile - variabel - variable - variable	

