

SERIE 250

  
**PROVEX**  
comfort in the bathroom

SISTEMA DI MANIGLIONI  
GRIFFSYSTEM  
GRAB BAR SYSTEM  
SISTEMA DE ASIDEROS



INDICE SERIE 250  
INHALT SERIE 250  
INDEX SERIE 250  
INDICE SERIE 250

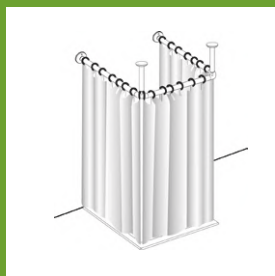
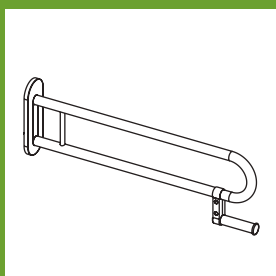
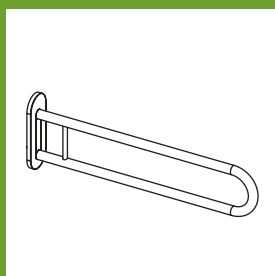
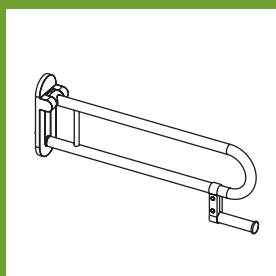
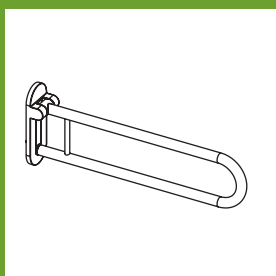
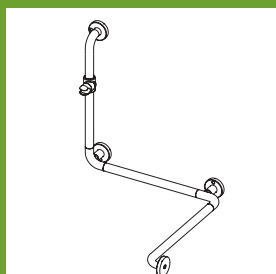
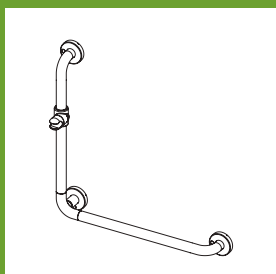
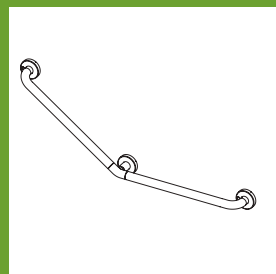
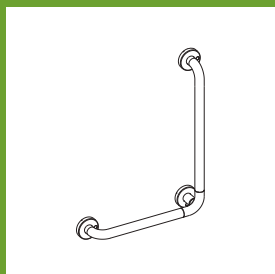
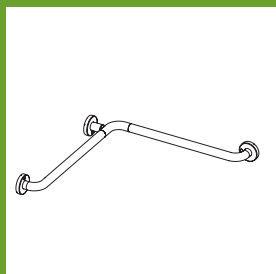
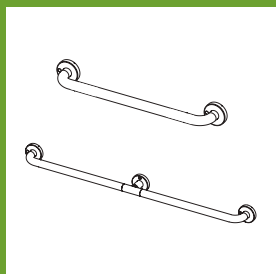



### SERIE 250 - SISTEMA DI MANIGLIONI

Caratteristiche ideali di pulizia grazie alla forma liscia, materiali di alta qualità, un sistema di costruzione modulare per la preparazione di misure speciali e un design moderno e chiaro, sono le eccezionali caratteristiche del sistema di maniglioni Serie 250. L'intero sistema è testato TÜV con una capacità portante tra 100 e 120 kg secondo la guida di riferimento per dispositivi medici CE EWG 93/42. Il sistema è prodotto in alluminio rivestito a polvere con copertura delle rosette resistenti UV. Questo programma si completa con il maniglione ribaltabile e di sostegno con/senza portarotolo e con una scelta di diverse variazioni di colori RAL, da impiegare sia nel settore privato che nel pubblico, privo di barriere.

### SERIE 250 - GRIFFSYSTEM

Ideale Reinigungseigenschaften durch die glatte Formgebung, hochwertige Materialien, modulares Baukastensystem für die Ausarbeitung von Sondermaßen und modernes, klares Design sind die herausragenden Merkmale des Griffsystems der Serie 250. Das gesamte System ist mit einer Belastbarkeit zwischen 100 und 120 kg laut TÜV getestet und entspricht den Richtlinien für Medizinprodukte CE EWG 93/42. Das System besteht aus pulverbeschichtetem Aluminium und UV-beständigen Rosettenabdeckungen. Komplettiert wird dieses Programm durch den Klapp- und Stützgriff mit/ohne Papierrollenhalter und einer Auswahl von verschiedenen RAL-Farbvarianten, die sowohl im privaten, als auch öffentlichem barrierefreien Sanitärbereich zum Einsatz kommen.

### SERIE 250 - GRAB BAR SYSTEM

Ideal cleaning characteristics through the smooth styling, high-quality materials, modular construction system for the elaboration of special measures and modern, clear Design are the outstanding characteristics of the handle system of the series 250. The entire system is tested with a maximum load-bearing capacity between 100 and 120 kg according to TÜV and corresponds to the guidelines for medicine products CE EEC 93/42. The system consists of powder-coated aluminium and UV resistant rosette covers. This program is completed by the folding and support handle with/without paperholder and a selection of different RAL color variants, which are used in the private as well as in the public barrier-free sanitary area.

### SERIE 250 - SISTEMA DE ASIDEROS

Características ideales de limpieza por la forma modular, materiales de alta calidad, sistema modular de construcción para la elaboración de medidas especiales y el diseño moderno y claro, son las características excepcionales del sistema de asideros de la serie 250. El sistema entero se prueba con una capacidad portadora máxima entre 100 y 120 kilogramos según certificado TÜV y corresponde a las pautas para EEC 93/42 del CE de los productos para medicina. El sistema consiste en aluminio polvo-revestido y es resistente a UV el rosetón. Este programa es completado con el asidero móvil y el asidero de apoyo si/no con el sostenedor de papel y una selección de diversas variantes de color RAL, que se utilizan tanto en el uso particular como en el área sanitaria pública con todas las normativas.

# SERIE 250 HG

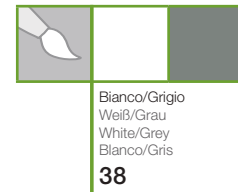
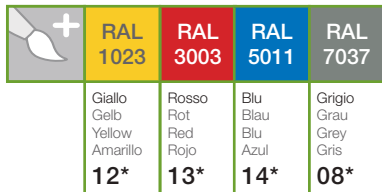
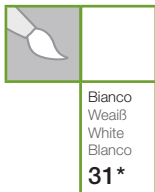
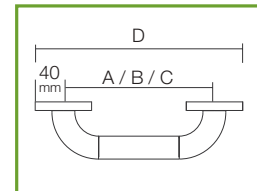

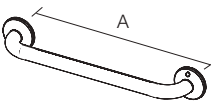
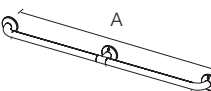
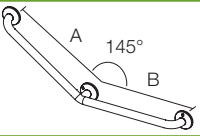
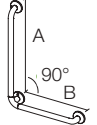
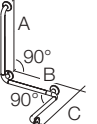
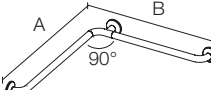
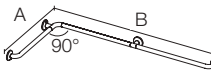
Descrizione articolo Artikelbezeichnung Model description Descripción artículo	Articolo Artikel Model Código	Misure Maße Sizes Medidas mm			
		A	B	C	D
 <p><b>Maniglione</b> Wandhaltegriff Holding handle Asidero fijo</p>	2020 HG * PM	250			330
	2021 HG * PM	300			380
	2022 HG * PM	400			480
	2023 HG * PM	500			580
	2024 HG * PM	600			680
	2025 HG * PM	700			780
	2026 HG * PM	800			880
 <p><b>Corrimano a parete</b> Wandhandlauf Wall handrail Barra de seguridad de pared</p>	2030 HG * PM	1050			1130
	2031 HG * PM	1150			1230
	2032 HG * PM	1250			1330
 <p><b>Maniglione 145° reversibile</b> Wandhaltegriff 145° reversibel Wall handle 145° reversible Asidero fijo 145° reversible</p>	2040 HG * PM	425	325		
	2041 HG * PM	625	425		
 <p><b>Maniglione 90° reversibile</b> Wandhaltegriff 90° reversibel Wall handle 90° reversible Asidero fijo 90° reversible</p>	2050 HG * PM	600	350		
	2051 HG * PM	600	450		
	2052 HG * PM	800	600		
 <p><b>Sostegno angolare con supporto verticale</b> Wandhaltegriff mit Senkrechtstütze Holding handle with vertical support Asidero fijo de pared con soporte vertical</p>	2060 HG * PM	650	570	540	
 <p><b>Corrimano singolo per doccia</b> Duschhandlauf einfach Single shower handrail Barra de seguridad simple</p>	2070 HG * PM	725	755		
 <p><b>Corrimano doppio per doccia</b> Duschhandlauf doppelt Double shower handrail Barra de seguridad doble</p>	2080 HG * PM	755	1180		

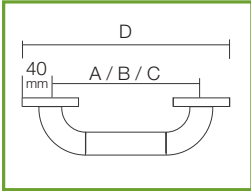

	Bianco Weiß White Blanco <b>31*</b>
--	---

	<b>RAL 1023</b> Giallo Gelb Yellow Amarillo <b>12*</b>	<b>RAL 3003</b> Rosso Rot Red Rojo <b>13*</b>	<b>RAL 5011</b> Blu Blau Blue Azul <b>14*</b>	<b>RAL 7037</b> Grigio Grau Grey Gris <b>08*</b>
--	---	--	--	---

Descrizione articolo Artikelbezeichnung Model description Descripción artículo	Articolo Artikel Model Código	Misure Maße Sizes Medidas mm				
		A	B	C	D	
<p><b>Sostegno per doccia con saliscendi</b> Brausestange mit Brausehalter Holding handle with shower holder Soporte para brazo de ducha</p>	2090 HG * PM	600			680	
	2091 HG * PM	800			880	
	2092 HG * PM	1000			1080	
<p><b>Sostegno per doccia a 90° con saliscendi</b> Haltegriff 90° mit Brausehalter Holding handle 90° with shower holder Soporte para brazo de ducha 90°</p>	2100 HG * PM	1000	450			
	2101 HG * PM	1190	450			
	2102 HG * PM	1190	650			
<p><b>Sostegno angolare con saliscendi</b> Duschhandlauf mit Brausehalter Wall handrail with shower holder Asidero fijo de pared con soporte para brazo de ducha</p>	2110 HG * PM	1000	570	725		
	2111 HG * PM	1190	710	725		
<p><b>Sostegno angolo a T con saliscendi</b> Duschhandlauf Ecke T-Form mit Brausehalter Handrail corner T-form with shower holder Barra de seguridad córner y T con brazo de ducha</p>	2120 HG * PM	1135	325	545	725	
	2121 HG * PM	1135	525	685	725	
<p><b>Corrimano a T con saliscendi</b> Handlauf T-Form mit Brausehalter Handrail T-form with shower holder Barra de seguridad T con brazo de ducha</p>	2130 HG * PM	1135	425	525		



<p><b>Saliscendi sciolto</b> Brausehalter lose Shower holder loose Soporte para ducha suelto</p>	0004 BR 38 PM	Abbinabile a tutti i maniglioni Passend für alle Griffe Suitable for all handles Adaptable para todo asideros
--	---------------	--

# SERIE 250 HG



	<b>RAL 1023</b>	<b>RAL 3003</b>	<b>RAL 5011</b>	<b>RAL 7037</b>
Bianco Weiß White Blanco	Giallo Gelb Yellow Amarillo	Rosso Rot Red Rojo	Blu Blau Blue Azul	Grigio Grau Grey Gris
<b>31*</b>	<b>12*</b>	<b>13*</b>	<b>14*</b>	<b>08*</b>

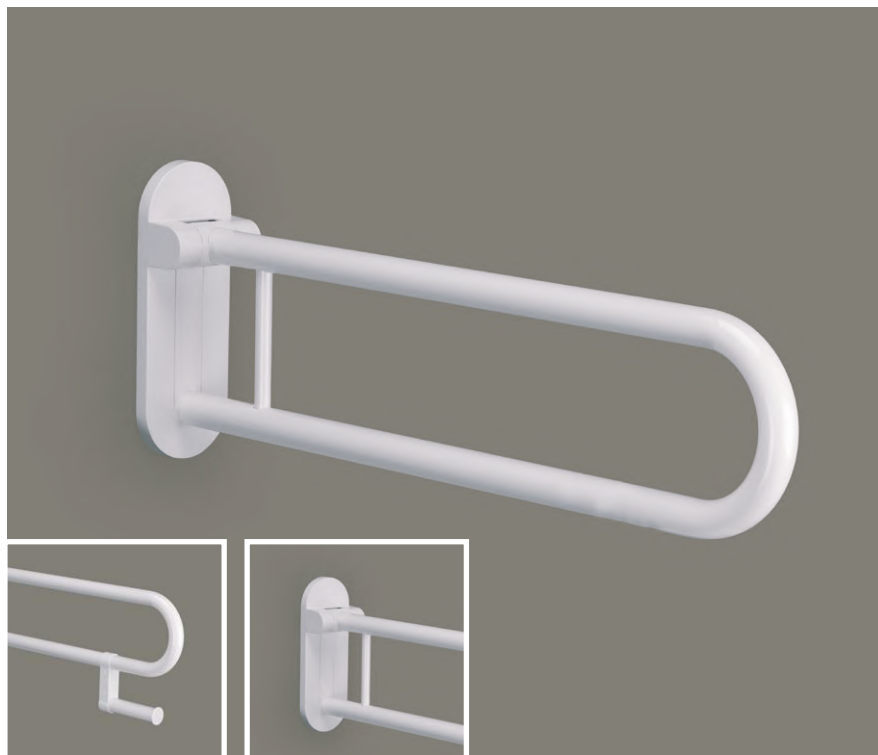

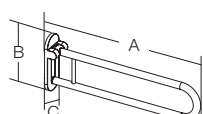
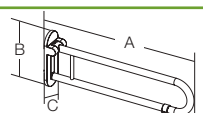
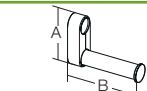
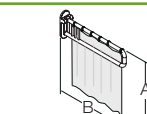
Descrizione articolo Artikelbezeichnung Model description Descripción artículo	Articolo Artikel Model Código	Misure Maße Sizes Medidas mm				
		A	B	C		
 <b>Appoggio ribaltabile</b> Klappgriff Folding handle Asidero móvil	2001 HG * PM	650	280	100		
	2002 HG * PM	750	280	100		
	2003 HG * PM	850	280	100		
 <b>Appoggio ribaltabile con portarotolo</b> Klappgriff mit Papierrollenhalter Folding handle with paper holder Asidero móvil con portarrollos	2201 HG * PM	650	280	100		
	2202 HG * PM	750	280	100		
	2203 HG * PM	850	280	100		
 <b>Portarotolo di riserva</b> Reserve Papierrollenhalter Additional paper holder Citapa de reserva	0262 BG 31 PM	115	150			
 <b>Tenda</b> Duschvorhang Shower curtain Cortina ducha	0050 VH 31 PM	850	640-850			

L'appoggio ribaltabile è in alluminio anodizzato di alta qualità ed è stato sviluppato in collaborazione con lo studio Talocci Design ed è la simbiosi perfetta tra design moderno e tecnica sicura. L'uso di raggi appropriati, la possibilità d'arretramento in ogni posizione e l'assenza di spigoli pericolosi, garantiscono un uso sicuro e delle buone caratteristiche di manutenzione.

Der Klappgriff besteht aus hochwertigem, pulverbeschichtetem Aluminium und wurde in Zusammenarbeit mit dem Designstudio Talocci Design und ist die perfekte Symbiose aus modernem Design und sicherer Technik. Der Einsatz geeigneter Radien, die Möglichkeit der Arretierung in jeder Position und die Vermeidung von Stoßkanten gewährleisten eine sichere Benutzung und gute Pflegeeigenschaften.

The folding handle consists of high quality, powder coated aluminium and was developed in co-operation with Design studio Talocci and is a perfect symbiosis between modern design and secure technology. The suitable radius, the possible locking mechanism in each position and curved edges ensure safe and easy use.

El asidero móvil está fabricado en aluminio anodizado y fue desarrollado en cooperación con el estudio Talocci Design y es una simbiosis perfecta entre el diseño moderno y tecnología segura. El radio apropiado, el mecanismo de bloqueo posible en cada posición y la ausencia de esquinas peligrosas, garantizan un uso seguro y un buen mantenimiento.

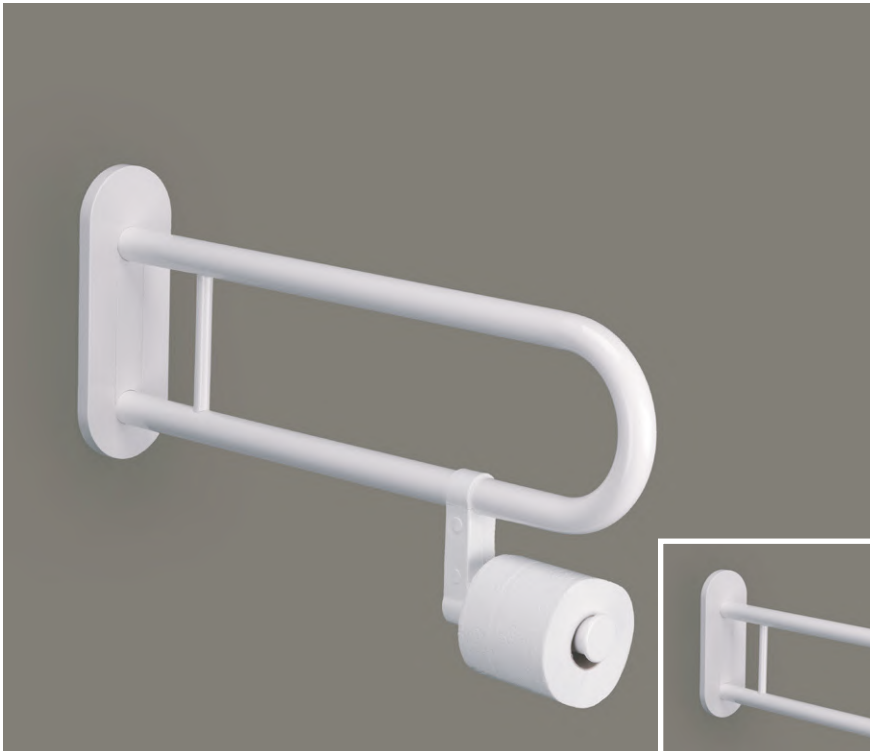

		<b>RAL 1023</b>	<b>RAL 3003</b>	<b>RAL 5011</b>	<b>RAL 7037</b>
	Bianco Weiß White Blanco	Giallo Gelb Yellow Amarillo	Rosso Rot Red Rojo	Blu Blau Blue Azul	Grigio Grau Grey Gris
	<b>31*</b>	<b>12*</b>	<b>13*</b>	<b>14*</b>	<b>08*</b>

Descrizione articolo Artikelbezeichnung Model description Descripción artículo	Articolo Artikel Model Código	Misure Maße Sizes Medidas mm					
		A	B	C			
<b>Maniglione di sostegno</b> Stützgriff Support handle Asidero de apoyo	2011 HG * PM	650	280	100			
	2012 HG * PM	750	280	100			
	2013 HG * PM	850	280	100			
<b>Maniglione di sostegno con portarotolo</b> Stützgriff mit Papierrollenhalter Support handle with paper holder Asidero de apoyo con portarollos	2211 HG * PM	650	280	100			
	2212 HG * PM	750	280	100			
	2213 HG * PM	850	280	100			
<b>Portarotolo di riserva</b> Reserve Papierrollenhalter Additional paper holder Citapa de reserva	0262 BG 31 PM	115	150				
<b>Tenda</b> Duschvorhang Shower curtain Cortina ducha	0050 VH 31 PM	850	640-850				

Il maniglione di sostegno è in alluminio anodizzato di alta qualità ed è stato sviluppato in collaborazione con lo studio Talocci Design ed è la simbiosi perfetta tra design moderno e tecnica sicura. L'uso di raggi appropriati, la possibilità d'arretramento in ogni posizione e l'assenza di spigoli pericolosi, garantiscono un uso sicuro e delle buone caratteristiche di manutenzione.

Der Stützgriff besteht aus hochwertigem, pulverbeschichtetem Aluminium und wurde in Zusammenarbeit mit dem Designstudio Talocci Design und ist die perfekte Symbiose aus modernem Design und sicherer Technik. Der Einsatz geeigneter Radien, die Möglichkeit der Arretierung in jeder Position und die Vermeidung von Stoßkanten gewährleisten eine sichere Benutzung und gute Pflegeeigenschaften.

The support handle consists of high quality, powder coated aluminium and was developed in co-operation with Design studio Talocci and is a perfect symbiosis between modern design and secure technology. The suitable radius, the possible locking mechanism in each position and curved edges ensure safe and easy use.

El asidero de apoyo está fabricado en aluminio anodizado y fue desarrollado en cooperación con el estudio Talocci Design y es una simbiosis perfecta entre el diseño moderno y tecnología segura. El radio apropiado, el mecanismo de bloqueo posible en cada posición y la ausencia de esquinas peligrosas, garantizan un uso seguro y un buen mantenimiento.

# SERIE 250 **VH + VN + VE + VU**

TUBO CON TENDA DOCCIA  
 DUSCHSTANGE MIT VORHANG  
 TUBE WITH SHOWER CURTAIN  
 BARRA CON CORTINA DE DUCHA

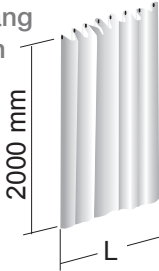
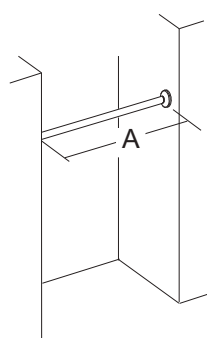
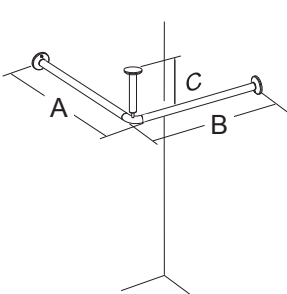
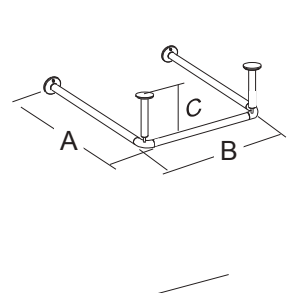
		Tende consigliate Passender Duschvorhang Suitable shower curtain Cortina aconsejable						
		Articolo Artikel Model Código	<b>0007 VH 31 PM</b> L = 1200 mm	<b>0010 VH 31 PM</b> L = 1500 mm	<b>0013 VH 31 PM</b> L = 1800 mm	<b>0019 VH 31 PM</b> L = 2400 mm	<b>0025 VH 31 PM</b> L = 3000 mm	<b>0031 VH 31 PM</b> L = 3600 mm
Nicchia - Nische - Niche - Huecos		<b>0004 VN 31 PM</b> A = 900 mm Anelli - Ringe - hooks - aillas 8	1x					
		<b>0005 VN 31 PM</b> A = 1000 mm Anelli - Ringe - hooks - aillas 10		1x				
		<b>0007 VN 31 PM</b> A = 1200 mm Anelli - Ringe - hooks - aillas 10		1x				
		<b>0010 VN 31 PM</b> A = 1500 mm Anelli - Ringe - hooks - aillas 12			1x			
Angolo - Ecke - Corner - Angular	 C = 585 mm	<b>0004 VE 31 PM</b> A = 900 mm B = 900 mm Anelli - Ringe - hooks - aillas 16				1x		
		<b>0005 VE 31 PM</b> A = 1000 mm B = 1000 mm Anelli - Ringe - hooks - aillas 16				1x		
		<b>0007 VE 31 PM</b> A = 1200 mm B = 1200 mm Anelli - Ringe - hooks - aillas 20					1x	
		<b>0010 VE 31 PM</b> A = 1500 mm B = 1500 mm Anelli - Ringe - hooks - aillas 24						1x
A "U" / "U"-Form / "U"-form / En "U"	 C = 585 mm	<b>0004 VU 31 PM</b> A = 900 mm B = 900 mm Anelli - Ringe - hooks - aillas 8 + 16	1x			1x		
		<b>0005 VU 31 PM</b> A = 1000 mm B = 1000 mm Anelli - Ringe - hooks - aillas 10 + 16		1x		1x		
		<b>0007 VU 31 PM</b> A = 1200 mm B = 1200 mm Anelli - Ringe - hooks - aillas 10 + 20		1x			1x	
		<b>0010 VU 31 PM</b> A = 1500 mm B = 1500 mm Anelli - Ringe - hooks - aillas 12 + 24			1x			1x



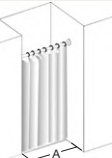
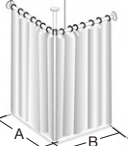
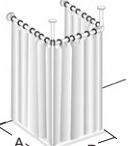
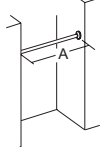
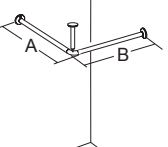
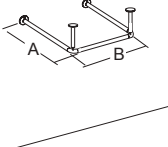

	<b>RAL 9010</b>
	Bianco Weiß White Blanco
	<b>31</b>

Descrizione articolo Artikelbezeichnung Model description Descripción artículo	Articolo Artikel Model Código	Misura piatto doccia Tassenmaß Tray size Medidas del plato mm			
		A	B		
 <p><b>Tenda nicchia</b> Duschvorhang Nische Shower curtain niche Cortina ducha forma de cavidad</p>	0007 VH 31 PM	900			
	0010 VH 31 PM	1000			
	0010 VH 31 PM	1200			
	0013 VH 31 PM	1500			
 <p><b>Tenda angolo</b> Duschvorhang Ecke Shower curtain corner Cortina ducha angular</p>	0019 VH 31 PM	900	900		
	0019 VH 31 PM	1000	1000		
	0025 VH 31 PM	1200	1200		
	0031 VH 31 PM	1500	1500		
 <p><b>Tenda a "U"</b> Duschvorhang "U"-Form Shower curtain "U"-form Cortina ducha en forma "U"</p>	0007 VH 31 PM + 0019 VH 31 PM	900	900		
	0010 VH 31 PM + 0019 VH 31 PM	1000	1000		
	0010 VH 31 PM + 0025 VH 31 PM	1200	1200		
	0013 VH 31 PM + 0031 VH 31 PM	1500	1500		
 <p><b>Tubo reggitenda nicchia</b> Duschstange Nische Shower curtain tube niche Barra cortina ducha forma de cavidad</p>	0004 VN 31 PM	900			
	0005 VN 31 PM	1000			
	0007 VN 31 PM	1200			
	0010 VN 31 PM	1500			
 <p><b>Tubo reggitenda angolo</b> Duschstange Ecke Shower curtain tube corner Barra ducha angular</p>	0004 VE 31 PM	900	900		
	0005 VE 31 PM	1000	1000		
	0007 VE 31 PM	1200	1200		
	0010 VE 31 PM	1500	1500		
 <p><b>Tubo reggitenda a "U"</b> Duschstange "U"-Form Shower curtain tube "U"-form Barra ducha en forma "U"</p>	0004 VU 31 PM	900	900		
	0005 VU 31 PM	1000	1000		
	0007 VU 31 PM	1200	1200		
	0010 VU 31 PM	1500	1500		