

THE GAP

Achievable design for all

BATHROOM
SOLUTIONS FOR
TODAY & TOMORROW

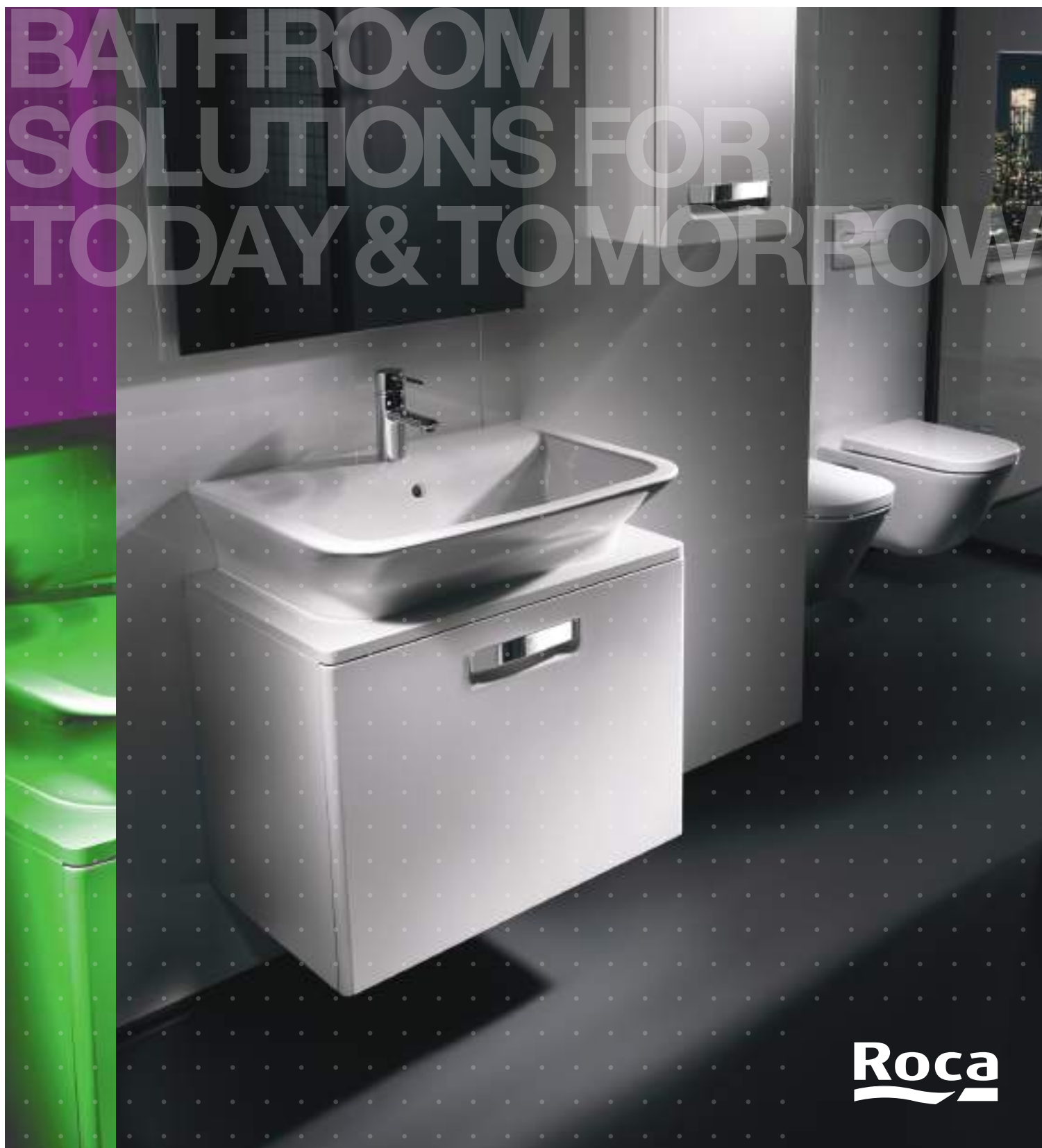

Roca

The Gap

Achievable design for all

The exciting bathroom and furniture collection **The Gap**, designed by Antonio Bullo, has subtle design details that complement the smooth, clean lines of each piece.

The Gap offers a wide choice of basins, WCs, bidets, furniture and baths to appeal to each individual need and allows the desired bathroom space to be perfectly tailored to each taste and requirement.





The Gap back-to-wall WC with Basic cistern and operating panel, back-to-wall bidet, Targa brassware.



4 ▣

The Gap close-coupled WC, floor standing bidet, Targa brassware.



CleanRim The Gap WC.

The Gap offers four WC options: CleanRim The Gap, close-coupled, back-to-wall, and wall-hung all with the option of soft-close or standard seats and covers.

CleanRim The Gap is rimless and flushes from an efficient distributor at the back of the toilet which has allowed us to reduce the flush volume to just 4 and 2 litres. It is also extremely hygienic and very easy to clean. The standard close-coupled cistern is available as 4.5/3 litre dual flush.

There are also three bidets available to perfectly complement all WCs: floor standing, back-to-wall and wall-hung all of which can also be installed with a soft-close or standard cover.



The Gap has a total of nine different basin options including: wall-hung, cloakroom, semi-recessed and corner basins, with sizes ranging from a generous 650mm to a compact 350mm. All wall-hung basins feature ground bases allowing easy installation on a countertop and giving greater choice for the consumer.





The Gap 650 x 470mm basin with The Gap 650mm base unit, The Gap column unit (RH), back-to-wall WC with Basic cistern and operating panel, back-to-wall bidet, Targa brassware, Luna mirror.



To complement **The Gap** basins there is an exclusive furniture collection with seven different size options to suit the 650, 600, 550, 500, 450, 400 and 350 basins.



The Gap 450 x 420mm basin with The Gap 450mm base unit, The Gap wall-hung WC with Pro bracket and operating panel, wall-hung bidet, Targa brassware, Luna mirror.





The Gap furniture is available in three matt finishes; Beige, White and Grape – something to suit all tastes. All three finishes will instantly add a sophisticated touch to any bathroom, whilst having the option of adding an accent of colour. Optional chrome legs are also available in pairs for the 650, 600, 550 and 500 base units if required (either 2 or 4 legs can be installed).



The Gap 450 x 420mm basin with The Gap 450mm base unit, Targa brassware, Luna mirror.

14 ▣

The Gap right hand column unit.





The Gap column unit and base units offer ample storage on the wall and beneath the basin. The column unit has two shelves, and the base units to suit the 450, 400 and 350 basins have a soft-closing door to maximise the space in more compact spaces. The larger base units to suit the 650, 600, 550 and 500 basins have a large soft-close drawer and all feature a polished chrome handle giving a modern and contemporary finish.



In addition this extensive range also features an acrylic bath collection and **The Gap Unik**. Available in five different sizes, including double-ended options, **The Gap** bath adds the perfect finishing touch to any bathroom space. **The Gap Unik** combines the basin, base unit and a Targa basin mixer (tap is optional) as one individual product, offering one complete solution. Available in three sizes: 800mm, 700mm and 600mm, it is perfect for those seeking maximum storage in the bathroom without compromising on style. Optional chrome legs are also available in pairs if required (either 2 or 4 can be installed).







17

The Gap Unik 700 x 440mm, Targa brassware, Luna mirror.

The Gap

Achievable design for all.

-  Dual flush system: 4/2 litres
-  Dual flush system: 4.5/3 litres
-  Soft-close seat and cover
-  Compact basin
-  Water-efficient product

Range of colours for vitreous china



White only.

Basin with fixing kit.

Ref. 327473000	650 x 470mm	1 taphole*	£135.51	(£162.61)
Ref. 327474000	600 x 470mm	1 taphole*	£107.11	(£128.53)
Ref. 327475000	550 x 470mm	1 taphole*	£88.37	(£106.04)
Ref. 32747J000	550 x 470mm	0 taphole	£88.37	(£106.04)
Ref. 327476000	500 x 420mm	1 taphole*	£86.02	(£103.22)
Ref. 327477000	450 x 420mm	1 taphole*	£75.41	(£90.49)
Ref. 32747K000	450 x 420mm	0 taphole	£75.41	(£90.49)

Pedestal.

Ref. 337470000	£55.38	(£66.46)
----------------	--------	----------

Semi-pedestal.

Ref. 337471000	£69.52	(£83.42)
----------------	--------	----------



18 ▯

CleanRim The Gap ECO WC

Rimless WC pan – 600mm projection moulded back-to-wall.

Ref. 34273700H £176.06 (€211.27)

Close-coupled cistern – 4/2 litres.

Ref. 34173C000 £184.76 (€221.71)

Soft-close WC seat and cover.

Ref. 801732004 £103.25 (€123.90)

Luxury WC seat and cover.

Ref. 801730004 £76.08 (€91.30)

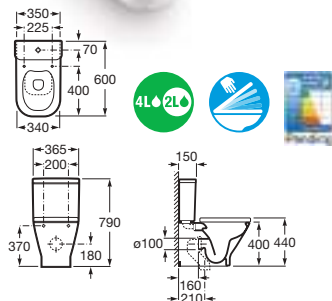

ECO WC, 650mm projection.

Close-coupled WC, dual outlet, with fixing kit.

Ref. 342477000 £146.11 (€175.33)

Cistern with dual flush 4.5/3 litres.†

Ref. 34147C000 £153.17 (€183.80)

Soft-close WC seat and cover.

Ref. 801472004 £87.19 (€104.63)

Luxury WC seat and cover.

Ref. 801470004 £65.99 (€79.19)

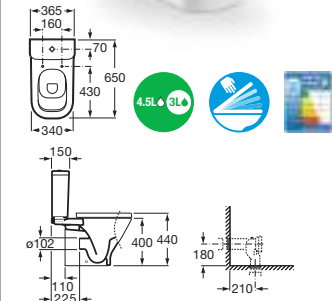

Back-to-wall WC, 540mm projection.

Ref. 347477000 £197.95 (€237.54)

Soft-close WC seat and cover.

Ref. 801472004 £87.19 (€104.63)

Luxury WC seat and cover.

Ref. 801470004 £65.99 (€79.19)

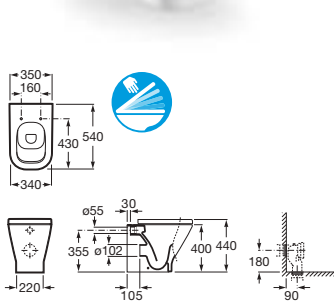

Wall-hung WC, 540mm projection.

Ref. 346477000 £288.68 (€346.42)

Soft-close WC seat and cover.

Ref. 801472004 £87.19 (€104.63)

Luxury WC seat and cover.

Ref. 801470004 £65.99 (€79.19)

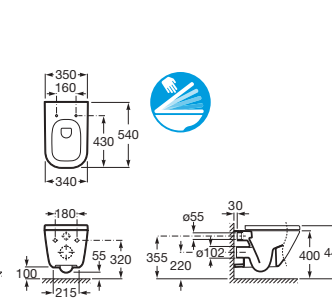

Cloakroom basin with fixing kit.

- Ref. 327478000
400 x 320mm 1 taphole £61.27 (£73.52)
- Ref. 327479000
350 x 320mm 1 taphole £61.27 (£73.52)
- Semi-pedestal.
Ref. 337472000 £49.48 (£59.38)

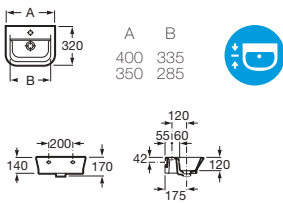

Corner basin with fixing kit.

- Ref. 32747R000 £140.22 (£168.26)

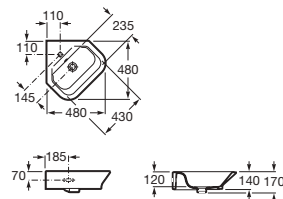

Semi-recessed basin with fixing kit.

- Ref. 32747S000 £131.97 (£158.36)

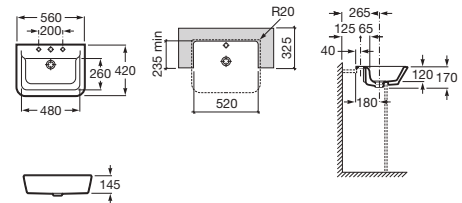

Floor standing bidet, 560mm projection.

- Ref. 357474000 1 taphole £148.46 (£178.15)
- Soft-close bidet cover.
Ref. 806472004 £90.20 (£108.24)
- Luxury bidet cover.
Ref. 806470004 £69.91 (£83.89)

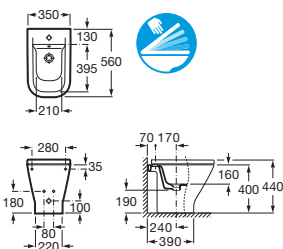

Floor standing back-to-wall bidet, 540mm projection.

- Ref. 357477000 1 taphole £159.07 (£190.88)
- Soft-close bidet cover.
Ref. 806472004 £90.20 (£108.24)
- Luxury bidet cover.
Ref. 806470004 £69.91 (£83.89)

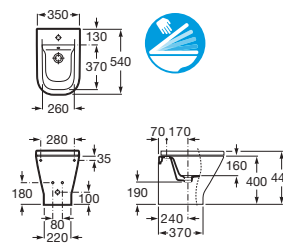

Wall-hung bidet, 540mm projection.

- Ref. 357475000 1 taphole £217.98 (£261.58)
- Soft-close bidet cover.
Ref. 806472004 £90.20 (£108.24)
- Luxury bidet cover.
Ref. 806470004 £69.91 (£83.89)

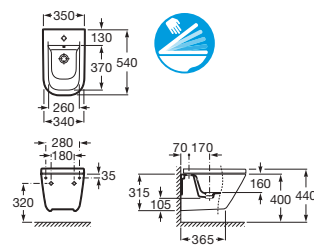

*These basins have countersunk holes which can be drilled to suit the number of holes required. 1 taphole basins can be drilled for 3 tapholes where required for a fee.
The prices shown are recommended retail prices excluding VAT (including VAT at the current rate of 20% shown in brackets) and are held until the end of February 2014.

The Gap

Achievable design for all.

Range of finishes for furniture.



575 Beige

576 White

577 Grape

Replace the (XXX) of the product reference with the chosen finish code.



Optional feet



Adjustable shelves



Soft close (drawers)



Opens to the left



Compact option



Opens to the right



Soft close (doors)



Water-efficient product

Range of colours for vitreous china and acrylic bath.

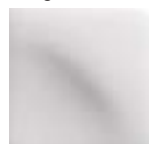

White only.

The Gap Unik

Basin and furniture solution.

Ref. 855712XXX

800 x 440mm.

£614.50

(£737.40)

Ref. 855711XXX

700 x 440 mm.

£569.40

(£683.28)

Ref. 855710XXX

600 x 440mm.

£535.57

(£642.68)

Optional legs 205mm.

Can be installed with 2 or 4 legs.

Ref. 816405001

(2 legs supplied).

£53.27

(£63.92)

Basin, furniture and tap solution (Targa basin mixer with pop-up waste).

Ref. 855T12XXX

800 x 440mm.

£709.22

(£851.06)

Ref. 855T11XXX

700 x 440mm.

£664.11

(£796.93)

Ref. 855T10XXX

600 x 440mm.

£619.02

(£742.82)

Base unit with drawer for 650, 600, 550 and 500 basins.

Ref. 856526XXX 675 x 415mm.

£473.56

(£568.27)

Ref. 856525XXX 600 x 415mm.

£426.21

(£511.45)

Ref. 856524XXX 555 x 415mm.

£378.85

(£454.62)

Ref. 856523XXX 500 x 390mm.

£343.32

(£411.98)

Optional legs 180mm.

Can be installed with 2 or 4 legs.

Ref. 816408001 (2 legs supplied).

£53.27

(£63.92)

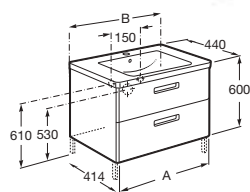
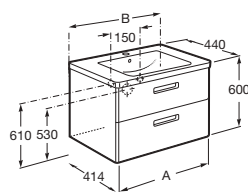

A	B
577	600
677	700
777	800



Base unit to suit 650 basin.

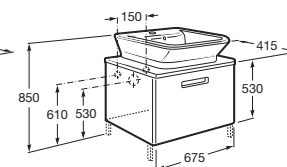
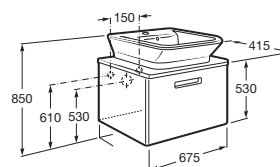

Base unit to suit 600 basin.

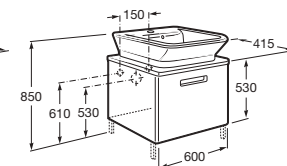
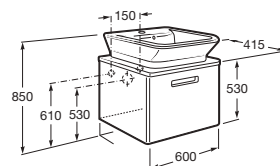

Single-ended baths.

- Ref. 024718000 1700 x 750mm 0 taphole 240 litres capacity £281.89 (£338.27)
- Ref. 024717000 1700 x 700mm 0 taphole 228 litres capacity £208.59 (£250.31)
- Ref. 024716000 1600 x 700mm 0 taphole 213 litres capacity £208.59 (£250.31)

Optional:

- Superthick front and end panels.
- Reinforced standard front and end panels.

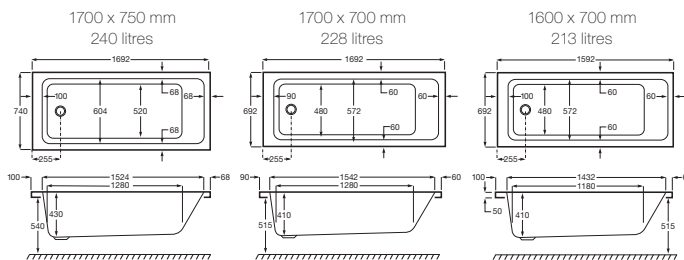
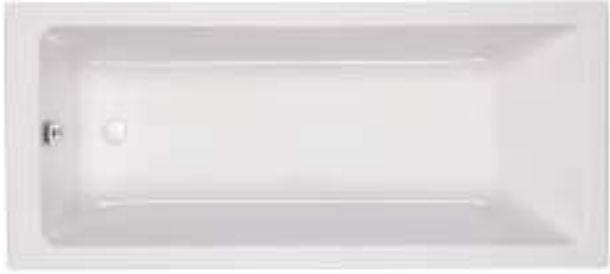

Double-ended baths.

- Ref. 024719000 1700 x 750mm 0 taphole 190 litres capacity £281.89 (£338.27)
- Ref. 024722000 1700 x 700mm 0 taphole 165 litres capacity £208.59 (£250.31)

Optional:

- Superthick front and end panels.
- Reinforced standard front and end panels.

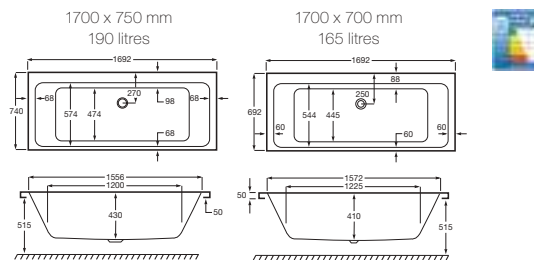

Base unit with door for 450, 400 and 350 basins.

- Ref. 856522XXX 444 x 390mm. £331.50 (£397.80)
- Ref. 856521XXX 400 x 302mm. £319.65 (£383.58)
- Ref. 856520XXX 344 x 302mm. £307.82 (£369.38)

Column unit

- 800 x 344 x 200mm.
- Ref. 856527XXX Right hand £405.91 (£487.09)
- Ref. 856528XXX Left hand £405.91 (£487.09)



Base unit to suit 550 basin.

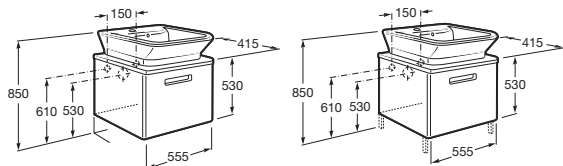

Base unit to suit 500 basin.

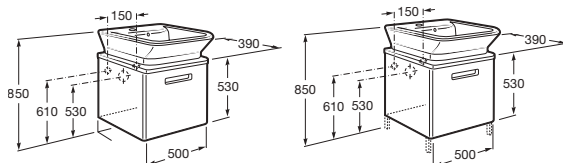

Base unit to suit 450 basin.

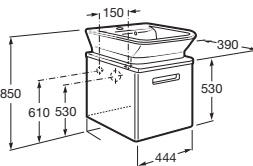

Base unit to suit 400 basin.

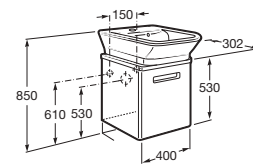

Base unit to suit 350 basin.

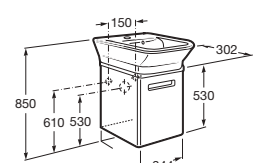

Left hand

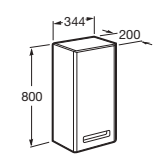

Right hand

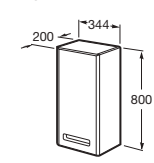

**Roca is the world leader
in bathroom spaces.**

For many years we have anticipated the future, thinking of solutions that better adapt to the public's tastes and requirements.

1. Ramón Benedito
2. Belén & Rafael Moneo
3. Antonio Bullo
4. Carles Ferrater
5. Ricard Ferrer
6. Giorgetto Giugiaro
7. Carlo Urbinati
8. Marcello Cutino
9. David Chipperfield
10. Schmidt & Lackner
11. Roviras & Torrente
12. Herzog & de Meuron
13. Magma Design
14. Gabriele & Oscar Buratti
15. Joan Gaspar



Design

We surround ourselves with the world's finest architects and designers, such as Chipperfield, Moneo, Schmidt & Lackner, Herzog & de Meuron... We want to offer a design that will make your bathroom a unique space.

Innovation

We have our own Innovation Lab where we experiment every day with new ideas, designs and materials, with the sole aim of enhancing your bathroom experience and providing solutions to make your everyday life more comfortable.

Sustainability

We love our planet and we prove it every day. This is why our products have advanced water and energy-saving devices that permit a balanced and sustainable coexistence with our environment.

Many of our products are registered with the Water Label Scheme, meaning they have been independently verified as being water efficient. Look out for the Water Label logo in the technical specifications section.

The Roca Guarantee

Every one of the products we sell complies with all specific European regulations. We offer you the finest product with the best guarantee. Our goal is your total satisfaction.

The quality of Roca products has been acknowledged throughout the world.

- 2013** ■ **Wallpaper* Design Awards.** In-Tank Meridian was awarded the Best Toilet Award.
- 2012** ■ **Designer Kitchen & Bathroom Magazine awards.** Bathroom Showroom of the Year 2012: Roca London Gallery. Gold winner for innovation in sustainability / functionality: L20 / Hide & Seat
■ **XV International Festival El Ojo de Iberoamérica.** Bronze Award in the category of design for Roca Galleries of Barcelona, Madrid, London and Lisbon.
■ **FIAP Awards.** First prize in the FIAP awards 2012 under the Design category, for the interactive and audiovisual content shared by the Barcelona, Madrid, London and Lisbon Roca Galleries.
■ **Design Week Awards.** Design Week Awards 2012. The London Roca Gallery awarded the prize for excellence and innovation under the Retail Interiors category, making it, once more, a benchmark for Design.
■ **SOL Awards.** 2012 SOL Award under the Branding and Design category for the interactive and audiovisual content shared by the Barcelona, Madrid, London and Lisbon Roca Galleries.
■ **Grand Laus Awards.** Awarded a prize at Grand Laus 2012 under the new "Company" category, for the interactive and audiovisual content shared by the Barcelona, Madrid, London and Lisbon Roca Galleries.
■ **Lighting Design Awards (UK).** The Roca London Gallery was recently named the winner of the Large Retail Project.
- 2011** ■ **XAVER 2011.** "The Wave", the space presented by Roca at the last 100% Design London exhibition, has been honoured with the award granted by the Expo+Event Swiss Association.
■ **Silver Delta Award** for the best product design for W+W.
■ **Gold IF Communication Design Award 2011.** Roca's space at the last 100% Design London show has been honoured by International Forum Design.
■ **"The 100 Best Ideas" of the year 2010.** Roca's W+W product has been honoured as one of the Best Ideas of the Year 2010, in the special ranking published by the prestigious magazine *Actualidad Económica*.
■ **Architectural Record 2011 Award.** The Roca Barcelona Gallery has won the Good Design is Good Business award in recognition of its excellence.
■ **Shortlisted at the XI Spanish Architecture and Urban Planning Biennale.** Roca Barcelona Gallery
- 2010** ■ **Cannes Lions 2010. Gold Lion.** Projection "Rituals" for Roca Barcelona Gallery.
■ **Cannes Lions 2010. Silver Lion.** Experience "Momentums" for Roca Barcelona Gallery.
■ **IALD Lighting Design Awards.** The world's most prestigious lighting award, granted to Roca Barcelona Gallery's façade.
■ **Wallpaper* Design Award winner.** W+W is the "Gold Winner" in the "Product Innovation Awards 2009," and the Roca Barcelona Gallery wins the Wallpaper* Design Award 2010.
- 2009** ■ **Red Dot award.** Awarded in the "Informative Design / Public Space" category for the best space at the 50th edition of the ISH 09 fair held in Frankfurt.
■ **Design Plus Award.** The W+W basin and toilet, designed by Gabriele & Oscar Buratti.
- 2008** ■ **The DME Design Management Europe Award.** A European distinction for the best design management in a large company.
■ **FAD Award for Ephemeral Spaces.** For the "Species Evolution" space presented at Casa Decor Barcelona 2007 by Martín Azúa and Nacho Martí.
■ **VII Tile of Spain Architecture and Interior Design Awards.**
- 2003** ■ **Top Ten Marketing Leader Award.**
- 2002** ■ **Spain's National Design Award.** The National Design Prizes, of an honorary nature, are the highest distinction awarded in Spain to companies who successfully use design in their innovation strategy.
- 2001** ■ **ADI-FAD Silver Delta Award:** Kalahari basin, designed by Benedito Design.
- 1999** ■ **The Barcelona Chamber of Commerce Epsilon Award,** granted by the ADI-FAD Executive Board for Design Quality in Business.
- 1997** ■ **Design Center Stuttgart International Design Award:** Sidrey vitreous china series and Amura faucet series, designed by Schmidt & Lackner.
- 1993** ■ **Design Center Stuttgart International Design Award:** Meridian vitreous china series, designed by Schmidt & Lackner.
■ **CEVISAMA Award,** International Industrial Design and Technological Innovation Competition: Clio basin, designed by Bernal/Isern.
■ **Prince Felipe Award** for Business Excellence, Industrial Design Section.
- 1992** ■ **Spain's National Quality Award.** The aim of the National Quality Prize is to disseminate the importance of quality as an indispensable factor in industrial activity
- 1974** ■ **Spanish Housing Ministry's Extraordinary Award** for Industrial Design. The Valencia Ceramics and Glass Show.

22 e



Roca



Roca Solutions.

Roca offers you a multitude of solutions for the various elements that make up your bathroom. For further information, please consult your Roca Dealer or visit www.uk.roca.com

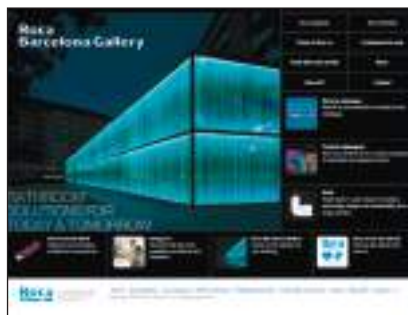

United Kingdom

Roca Limited

Samson Road
Hermitage Industrial Estate
Coalville, Leicestershire.
LE67 3FP – UK
Telephone +44 1530 830080
Fax +44 1530 830010
www.uk.roca.com

Roca London Gallery

Station Court
Townmead Road
London
SW6 2PY – UK
Telephone +44 20 7610 9503
www.rocalondongallery.com

Roca Ireland

Unit 628A Jordanstown Avenue
Greenogue Industrial Estate
Rathcoole
Co. Dublin
Telephone +35 301 401 9340

Head Office

Roca Sanitario, S.A.

Avda. Diagonal, 513
08029 Barcelona – Spain
Telephone +34 93 366 1200
Fax +34 93 419 4501
www.es.roca.com
www.roca.es

Roca Barcelona Gallery

Joan Güell, 211-213
08028 Barcelona – Spain
Telephone +34 93 366 12 12
Fax + 34 93 339 68 74
www.rocabarcelonagallery.com

Roca Madrid Gallery

José Abascal, 57
28003 Madrid – Spain
Telephone +34 91 442 3034
Fax + 34 91 399 2227
www.rocamadridgallery.com

Expo Bath Barcelona

Avda. Sarriá, 131-135
08017 Barcelona – Spain
Telephone +34 93 280 2929
Fax +34 93 280 0236

Roca in Europe

Germany

Roca GmbH
Feincheswiese 17
D-56424 Staudt – Germany
Telephone +49 2602 93 610
Fax +49 2602 93 6122
www.roca.com/de

Austria

Laufen Austria, AG.
Mariazeller Strasse, 100
A-3150 Wilhelmsburg – Austria
Telephone +43 2746 60 60 0
Fax +43 2746 60 60 390
www.roca.com

Benelux

Laufen Benelux, B.V.
Postbus 2702
NL-3821 BM Amersfoort –
The Netherlands
Telephone +31 0 33 450 20 90
Fax +31 0 33 450 20 91
www.rocabathrooms.nl

Bulgaria

Roca Bulgaria A.D
5, Pirotska Str.
1301 Sofia – Bulgaria
Telephone +359 2 9305910
Fax +359 2 9305919
www.roca-bulgaria.bg

Showroom Sofia

16, Maria Luiza Blvd
1000 Sofia – Bulgaria
Telephone +359 2 939 60 90
Fax +359 2 939 60 80

Croatia

Inker
Industrijska, 1
10290 Zapresic – Croatia
Telephone +385 133 103 64
Fax +385 133 102 75
www.roca.com

Slovakia

Laufen SK s.r.o.
Stefanovicova 12
811 04 Bratislava – Slovakia
Telephone +421 252 621 024
Fax +421 252 621 025
www.roca.cz

Spain

Roca Sanitario, S.A.
Avda. Diagonal, 513
08029 Barcelona – Spain
Telephone +34 93 366 1200
Fax +34 93 419 4501
www.roca.com

Showroom Madrid

José Abascal, 57
28003 Madrid – Spain
Telephone +34 91 441 3500
Fax + 34 91 442 4802

Showroom Barcelona

Avda. Sarriá, 131-135
08017 Barcelona – Spain
Telephone +34 93 280 2929
Fax +34 93 280 0236

France

Roca
B.P. 90422
95005 Cergy – Pontoise Cedex –
France
Telephone +33 134 40 3900
Fax +33 130 37 0265 / 134 64 1355
www.roca.fr

Greece

Roca Hellas, S.A.
59, Agiou Konstantinou&Elenis street
Ag. Dimitrios
17342 Athens – Greece
Telephone +30 210 8054721
Fax +30 210 8054721
www.roca.com

Hungary

Laufen CZ s.r.o.
Ördögárok u. 121
H-1029 Budapest – Hungary
Telephone +36 1 376 96 24
Fax +36 1 376 96 24
www.roca.com

Italy

Roca S.r.l.
Via Leonardo da Vinci, 24
20080 Casarile (MI) – Italy
Telephone +39 02 90 02 51
Fax +39 02 90 52174
www.roca-italia.it

Baltic states

Laufen CZ s.r.o. – Baltic Office
Užupio g. 30
LT-01203 Vilnius – Lithuania
Telephone +370 5 215 3076
Fax +370 5 215 3086
www.roca.lt

Nordic countries

Laufen Nordic Aps
Fejovvej 8
DK-4652 Hårlev – Denmark
Telephone +45 56 287 287
Fax +45 56 287 237
www.roca.com

Poland

Roca Polska Sp. z o.o.
ul. Wyczółkowskiego, 20
44-109 Gliwice – Poland
Telephone +48 32 339 4100
Fax +48 32 339 4102
www.roca.pl

Portugal

Roca S.A.
Apartado 575
Ponte da Madalena
2416 – 905 Leiria – Portugal
Telephone +351 244 720 000
Fax +351 244 722 373
www.roca.pt

United Kingdom

Roca Limited
Samson Road
Hermitage Industrial Estate
Coalville, Leicestershire. LE67 3FP – UK
Telephone +44 1530 830080
Fax +44 1530 830010
www.uk.roca.com

Czech Republic

Laufen CZ s.r.o.
V Tuřích 3/1637
CZ-120 00 Praha 2 – Czech Republic
Telephone +420 296 337 716
Fax +420 296 337 713
www.roca.cz

Showroom Praha

I.P. Pavlova 5
CZ-120 00 Praha 2 – Czech Republic
Telephone +420 296 337 701

Romania

Roca Obiecte Sanitare S.R.L.
Boulevard Preciziei, 1 nr. 1 Sector 6
062202 – Bucarest – Romania
Telephone +4031 822 2310
Fax +4021 318 1418
www.roca.com

Russia

Roca Santekhnika
Promyshlennaya Str. 7, Tosno,
Leningrad region, 187000 – Russia
Telephone +7 812 347 94 49
Fax +7 812 347 94 50
www.roca-russia.ru

Roca Santekhnika (Moscow)

Altufievskoye shosse, 1/7
Moscow, 127106 – Russia
Telephone +7 495 956 33 30 / 230
65 48
Fax +7 495 234 07 97
www.roca-russia.ru

Ukraine

Laufen CZ s.r.o. – Ukraine Office
19, Ak. Tupoleva str., office "Laufen"
Kiev 04128 – Ukraine
Telephone +380 44 499 0620
Fax +380 44 499 0621
www.roca.net.ua

Roca in Asia

China

Roca (China) Co., Ltd.
Room 503-505 City Gateway
No.396 Cao Xi Road North
200030 Shanghai – China
Telephone +86 21 33688822
Fax +86 21 33688299
www.roca.cn

Showroom Shanghai

1F City Gateway
No.396 Cao Xi Road North
200030 Shanghai – China
Telephone +86 21 33688300
Fax +86 21 33688301

Showroom Beijing

Roca Showroom
1st Floor of Tianheng Plaza
No.46 of Dongzhimenwai Street
Dongcheng district
100027 Beijing – China
Telephone +86 10 84608586 /
+86 10 84608588
Fax +86 10 64176997

Hong Kong

Roca Asia Limited
Room 2303, 23/F
148 Electric Road, North Point –
Hong Kong
Telephone +852 25 06 24 38
Fax +852 25 06 24 92
www.roca.hk

India

Parryware Roca Pvt. Ltd.
Dare House, 234. N.S.C. Bose Road
Chennai 600 001 – India
Telephone +91 44 2530 6789
Fax +91 44 2534 0034
www.rocaindia.com

Malaysia

Johnson Suisse Sdn. Bhd. (257640-V)
Lot 2, Jalan 225, Petaling Jaya,
46100 Selangor Darul Ehsan – Malaysia
Telephone +603 7952 2522
Fax +603 7958 6860
www.roca.com

Middle East

Roca Sanitario, S.A.
(Representation Office)
Sheikh Zayed Road, 4th Interchange
Gold & Diamond Park, Building 5, Office
111 P.O. Box 282337, Al Quoz Branch
Dubai – United Arab Emirates
Telephone +971 4 347 64 00
Fax +971 4 347 64 08
www.roca.com

Singapore

Johnson Suisse (Singapore) Pte Ltd
No. 2, Clementi Loop, #04-01
Logishub @ Clementi
Singapore 129809
Tel +65 6261 6133
Fax +65 6265 5979
www.roca.com

Roca in Africa

Morocco

Roca Maroc, S.A.
Route de Marrakech, Km. 2,5
B.P. 571 – 26000 Serrat – Morocco
Telephone +212 23 40 5941 / 40 3939
Fax +212 23 40 5942
www.roca.com

Showroom Casablanca

96, Bd Massira Al Khadra
20100 Casablanca – Morocco
Telephone +212 22 39 6096
Fax +212 22 36 6019

Roca in America

Argentina

Roca Argentina, S.A.
Camino Gral. Belgrano,
2873 – B1824JRH
Lanús – Buenos Aires – Rep. Argentina
Telephone +54 11 4365 5000
Fax +54 11 4365 5024
www.roca-argentina.com.ar

Brazil

Roca Brasil Ltda.
Av. 14 de Dezembro, 2800
Vila Mafalda 13206 – 105
Jundiaí – SP – Brazil
Telephone +51 11 3378 4827
Fax +51 11 3378 4629
www.rocabrasil.com.br

Showroom São Paulo

Avenida Brasil, 2188
Jardim América
São Paulo – SP – CEP 01430-001
– Brazil
Telephone +51 11 3061 5266

Roca in Oceania

Australia

Roca
Macquarie House
Level 13, Office 1318
167 Macquarie Street
Sydney NSW 2000 – Australia
Telephone +61 (0) 2 86673069
www.roca.com



THE LEADING GLOBAL
BATHROOM BRAND
www.roca.com